

PASSIVE AND HYBRID SOLAR LOW ENERGY BUILDINGS

# PASSIVE SOLAR HOMES: CASE STUDIES

# 6

DESIGN INFORMATION BOOKLET NUMBER SIX

DECEMBER 1990

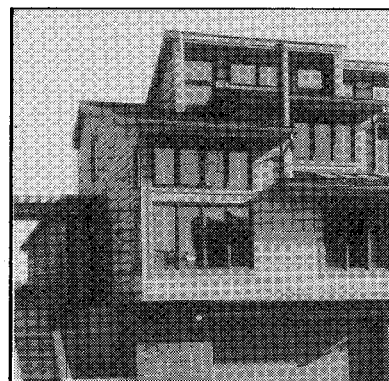
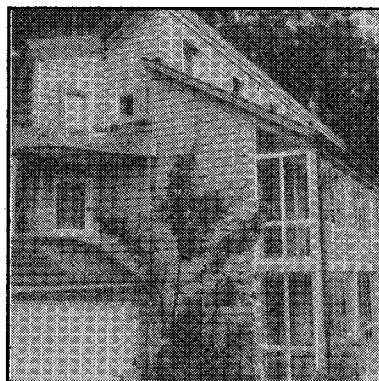
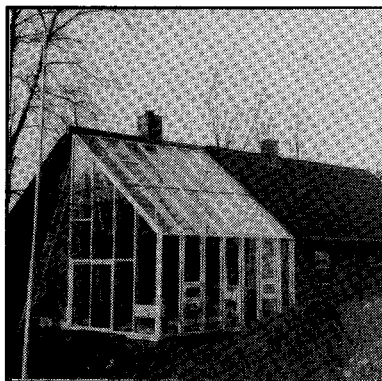
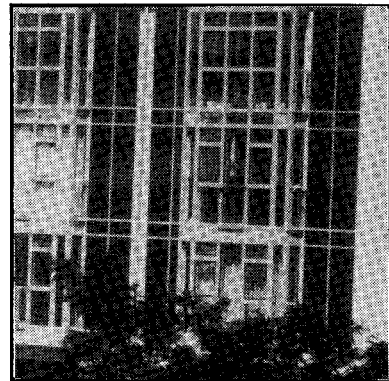
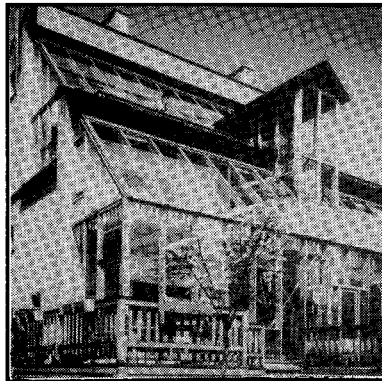
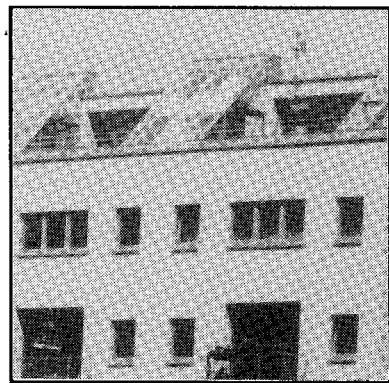
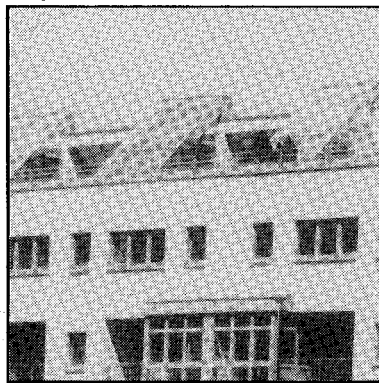
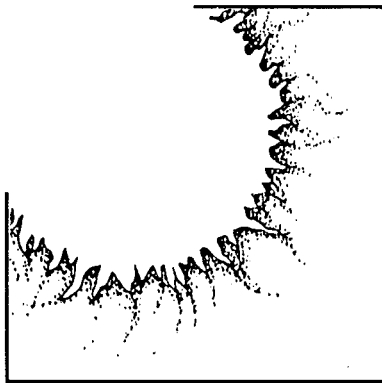

**NOTICE:**

This report was prepared as an account of work sponsored by the U.S. Department of Energy under Contract No. DE-AC03-87SF16667 for the International Energy Agency. Neither the U.S. Government nor the International Energy Agency, nor any of their employees, nor any of their contractors, subcontractors, or their employees makes any warranty, expressed or implied, or assumes any legal liability or responsibility for the accuracy, completeness, or usefulness of any information, apparatus, product or process disclosed, or represents that its use would not infringe privately owned rights.

**REPORT NO. IEA SHAC T.8.C.6**

PASSIVE AND HYBRID SOLAR LOW ENERGY BUILDINGS

# **PASSIVE SOLAR HOMES: CASE STUDIES**

# **6**

DESIGN INFORMATION BOOKLET NUMBER SIX

DECEMBER 1990

Editors:

Hans Kok  
Bouwcentrum  
Rotterdam, The Netherlands

Michael J. Holtz  
Architectural Energy Corporation  
Boulder, Colorado

INTERNATIONAL ENERGY AGENCY: SOLAR HEATING AND COOLING PROGRAM, TASK VIII

# FOREWORD

---

The International Energy Agency (IEA), headquartered in Paris, France, was formed in November 1974 to establish cooperation among a number of industrialized countries in the vital area of energy policy. It is an autonomous body within the framework of the Organization for Economic Cooperation and Development. Twenty-one countries are presently members, with the Commission of the European Communities participating under a special arrangement.

One element of the IEA's program involves cooperation in the research and development of alternative energy resources in order to reduce excessive dependence on oil. A number of new and improved energy technologies that have the potential of making significant contributions to global energy needs were identified for collaborative efforts. Solar heating and cooling was one of the technologies selected for joint activities. Cooperative research is conducted under terms of a formal Implementing Agreement signed by the participating countries. One of the collaborative projects, Task VIII, concerns passive and hybrid solar, low energy buildings.

The goal of Task VIII is to accelerate the technical understanding and marketplace availability of energy-efficient, passive solar homes. Fourteen countries have participated in the research - Austria, Belgium, Canada, Denmark, Federal Republic of Germany, Italy, Netherlands, New Zealand, Norway, Spain, Switzerland, Sweden, the United Kingdom, and the United States.

The knowledge gained during this collaboration has been assembled in a series of eight booklets. The Design Information Booklets in the series are listed and described on the opposite page. Information on purchasing these booklets can be obtained by contacting the following organizations or by ordering directly from the U.S. Government Printing Office:

**Austria**

Osterreichisches  
Forschungszentrum Seibersdorf  
A - 2444 Seibersdorf

**Germany**

Projektleitung Biologie, Ökologie  
und Energie  
KFA Jülich  
Postfach 1913  
D - 5170 Jülich

**Norway**

NTNF  
P.O. Box 70 Tasa  
0801 Oslo

**United Kingdom**

Renewable Energy Enquiries  
Bureau  
Energy Technology Support Unit  
Harwell Laboratory, Building 156  
Oxfordshire OX 11 0RA

**Belgium**

Science Policy Office  
Rue de la Science 8  
B - 1040 Brussels

**Italy**

Consiglio Nazionale Ricerche  
Progetto Finalizzato Energetica  
Via Nizza 128  
I - 00198 Roma

**Spain**

IER - CIEMAT  
Avda Complutense 22  
28040 Madrid

**United States**

Technical Inquiry Service  
Solar Energy Research Institute  
1617 Cole Boulevard  
Golden, Colorado 80401

**Canada**

Solar Energy Development  
Program  
Energy, Mines and Resources  
460 O'Connor Street  
Ottawa, Ontario K1A 0E4

**Netherlands**

Management Office for Energy  
Research (PEO)  
P.O. Box 8242  
NL - 3503 - RE Utrecht

**Sweden**

Svensk Byggtjänst,  
Litteratutjänst  
Box 7853,  
103 99 Stockholm

**Other**

Superintendent of Documents  
U.S. Government Printing Office  
Washington, D.C. 20402-9372

**Denmark**

Thermal Insulation Laboratory  
Technical University of Denmark  
Building 118  
DK - 2800 Lyngby

**New Zealand**

School of Architecture  
Victoria University of Wellington  
Private Bag  
Wellington 1

**Switzerland**

Federal Office of Energy  
CH - 3003 Berne

The U.S. Department of Energy (DOE) is the Operating Agent of IEA Task VIII: Passive and Hybrid Solar Low Energy Buildings. Michael J. Holtz of Architectural Energy Corporation, Boulder, Colorado, serves as Task Chairman on DOE's behalf.

# DESIGN INFORMATION BOOKLET SERIES

---

## **Booklet No. 1 Energy Design Principles In Buildings**

This Booklet is essentially a primer of heat transfer in buildings. Fundamental heat transfer concepts and terminology are defined, followed by a discussion of heating and cooling strategies and principles for passive and hybrid solar buildings. It is written in non-technical language for the designer or builder not familiar with general heat transfer principles in buildings.

## **Booklet No. 2 Design Context**

Booklet number 2 defines, in a checklist format, the issues that are unique to energy-conserving, passive solar design that must be considered early in the design process. Issues discussed include site and climate analysis, building organization and design, building system options, space conditioning options, user influence, and building codes and zoning ordinances.

## **Booklet No. 3 Design Guidelines: An International Summary**

Passive solar and energy conservation design guidelines have been developed by each participating country. These guidelines are presented in national design guidelines booklets. Booklet number 3, Design Guidelines: An International Summary, summarizes the major findings and patterns of performance observed from the national passive solar and energy conservation guidelines.

## **Booklet No. 4 Design Tool Selection And Use**

This Booklet addresses the characteristics desirable in a design tool and a means to select one or more for use. The selection process is organized around the design process; what design questions are being addressed, what information is available, what output or result from a design tool for which one is looking. A checklist is provided to assist in design tool selection. The use of benchmark test cases developed from detailed building energy analysis simulations is presented as a means to evaluate simplified design tools.

## **Booklet No. 5 Construction Issues**

Construction problems unique to the use of passive and hybrid solar features are defined in this booklet as well as several proven solutions. Due to the unique construction technology in each country, representative construction details are provided. The intent is to define where construction detailing is crucial to the performance of low energy, passive solar homes and provide some ideas on how these detailing problems can be solved for a range of construction technology.

## **Booklet No. 6 Passive Solar Homes: Case Studies**

This Booklet describes the passive and hybrid solar houses designed, constructed and monitored under the IEA Task VIII project, as a means of showing the architectural impact of energy conservation and passive/ hybrid solar features. This booklet reinforces the idea that good energy design is also good architecture and is cost-effective. Each of the passive solar houses is presented as a case study on the design, construction, and performance results.

## **Booklet No. 7 Design Language**

Booklet Number 7 is aimed at designers, architects, and educators. It defines an approach to generating whole building solutions based on climate analysis and design context analysis. It also addresses architectural typologies based on climatic/energy principles. This booklet forms a general, universal companion to Booklet Number 3, Design Guidelines.

## **Booklet No. 8 Post Construction Activities**

Post Construction Activities defines issues to be considered once the project is constructed and occupied. It addresses those elements of the passive solar building that are unique and may require special attention by the occupants. Performance evaluation of the home in terms of energy performance, comfort, and occupant satisfaction is also addressed as a means of providing information back to the designer on how well the project is performing.

# ACKNOWLEDGEMENTS

---

This document is the compilation of thirteen case studies written by individual authors in the ten participating countries. Consequently, each case study author must be individually recognized and acknowledged.

Austria:	Manfred Buck Ingenieurkonsulent für Technische Physik
Denmark:	Ove Morck Cenergia ApS
Germany:	Gustav Hillmann Institut für Bau-Umwelt-und Solarforschung GMBH Berlin
Italy:	Sergio Los, Natasha Pulitzer Istituto Universitario di Architettura di Venezia
Netherlands:	Hans Kok Bouwcentrum
Norway:	Anne Grete Hestnes Norwegian Institute of Technology
Spain:	Jaime Lopez de Asiain Seminario de Arquitectura Bioclimatica
Sweden:	Lars Engstrom VBB AB
Switzerland:	Gerhard Zwiefel EMPA/KWH
United States:	Michael Holtz Architectural Energy Corporation

The editors also wish to acknowledge the helpful comments and suggestions provided by the Subtask C participants and the authors of the other booklets in the Design Information Booklet series, including Ms. Anne Minne, Mr. Gunter Lohnert, Mr. Michael Holtz, Mr. Hans Kok, Mr. Sergio Los, N. Pulitzer, Ms. Shelia Blum, and Mr. Ron Brewer.

Also, the editors wish to acknowledge the assistance of Jan van 't Hof of Bouwcentrum and Susan Hollingsworth of Architectural Energy Corporation in preparing the camera-ready copy.

This booklet is dedicated to Lars Engstrom, a dear, gentle, and loving friend, who enriched the lives of all who knew him and worked with him. We will miss him.



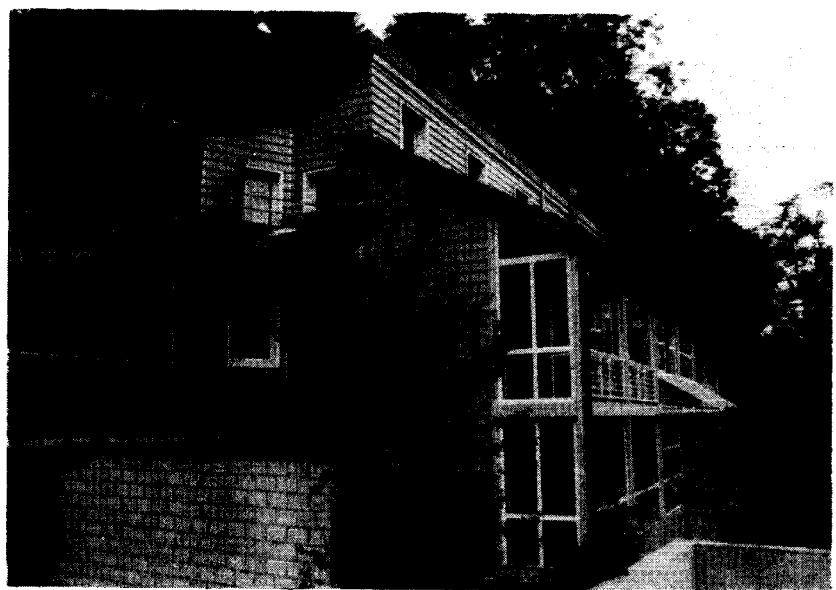



This booklet presents as case studies the thirteen passive and hybrid solar low energy residential buildings designed, constructed and monitored as part of Task VIII of the IEA's Solar Heating and Cooling Program. Their energy saving design features were developed from research conducted as part of the fourteen country IEA cooperative effort on passive and hybrid solar low energy buildings. A major goal of Task VIII was to verify that passive and hybrid solar homes can substantially reduce the building load and consumption of non-renewable energy over that of conventional buildings while maintaining acceptable levels of year-round comfort.

## 1.1 GENERAL

Task VIII was concerned with only new single and multi-family residential buildings. A unique aspect of Task VIII was its emphasis of "integrated residential energy design," combining solar heating, energy conservation and advanced mechanical systems into optimized energy-efficient dwellings.

An underlying intent of Task VIII was to gather, organize, evaluate, apply, and share the current body of knowledge on passive and hybrid solar and low energy buildings design and construction. Thus, the projects presented in this booklet are exemplary of passive solar designs based on current architectural styles and using available materials and components.

Thirteen projects have been built in ten countries, as shown in Figure 1. The locations of these projects represent large variations in climate, construction practices and material, energy sources and costs, and architectural preferences.

## 1.2 LOCATIONS

Table 1 summarizes several key climatic parameters. Although every location has its unique climatic conditions due to variations in topography, ground surface and obstructions, regional patterns of climate exist based on similarity of temperature, humidity, solar radiation, air movement, and sky conditions. To understand these common climatic conditions, a climate similarity index was developed and applied to a number of cities within the Task VIII participating countries. Based on the work of Derickson and Holtz (1), the climate similarity index for heating ( $CSI_H$ ) is a measure of similarity between climates using the

ratio of incident solar radiation on a south facing vertical surface (VS) to the total of heating degree days (HDD). This VS/HDD ratio is a useful indicator of climate related heating load (1). Table 1 identifies the climate region for heating for each of the project locations based on this VS/HDD climate similarity index.

- 1. NORWAY
  - a. Trondheim
  - b. Oslo
- 2. SWEDEN
  - Stockholm
- 3. DENMARK
  - Smakkebo
- 4. GERMANY
  - Berlin
- 5. THE NETHERLANDS
  - Hoek van Holland
- 6. SWITZERLAND
  - a. Wald
  - b. Schuepfen
- 7. AUSTRIA
  - Purkersdorf
- 8. ITALY
  - Lana Village
- 9. SPAIN
  - Mairena (Sevilla)
- 10. UNITED STATES
  - a. Boulder, Colorado
  - b. Oakton, Virginia

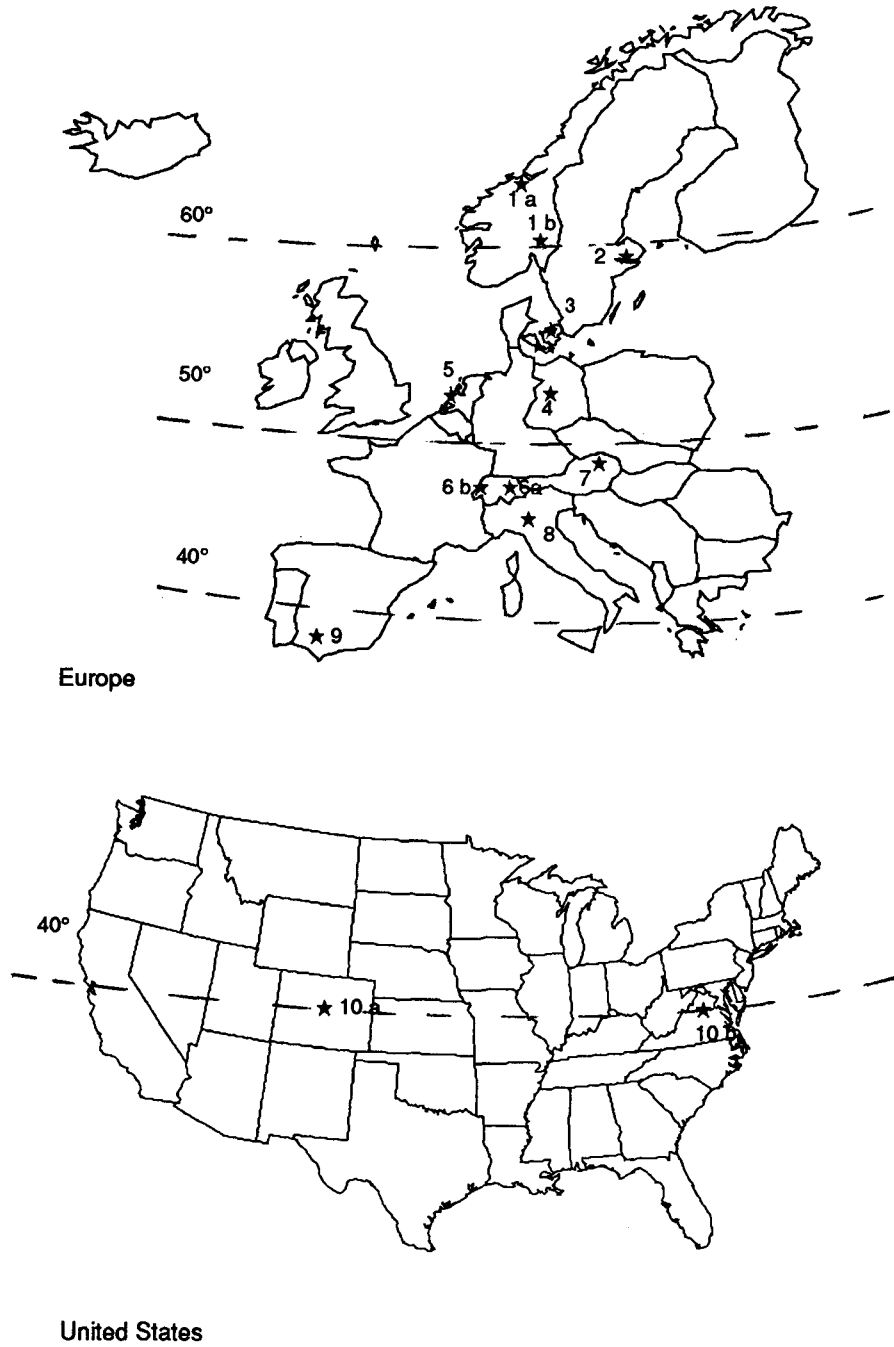

Figure 1: Project Locations

TABLE 1: CLIMATE CHARACTERISTICS

Country	City/Town	Latitude °N	Average winter temp. °C	Average summer temp. °C	HDD	Sunshine Hours	Climate Region (Heating)
Austria	Purkersdorf	48	4.0	17.0	3.462	1.836	1
Denmark	Smakkebo	55	2.4	12.8	3.676	1.570	2
Germany	Berlin	52	7.0	16.7	3.535	1.706	2
Italy	Lana	46	5.6	22.0	2.580	2.032	4
Netherlands	Hoek van Holland	52	6.9	16.1	3.031	1.505	2
Norway	Malvik	63	0.3	11.3	4.799	1.350	1
	Lorenskog	60	-0.3	13.4	3.744	1.756	1
Spain	Mairena del Aljaraf	37	12.6	22.0	438	3.000	7
Sweden	Stockholm	59	5.5	12.7	3.764	1.970	1
Switzerland	Schuepfen	47	5.8	17.0	3.420	1.662	4
	Wald	47	5.6	12.5	3.774	1.503	3
United States	Boulder, Colorado	40	3.7	18.5	3.842	3.295	7
	Oakton, Virginia	39	5.9	20.6	2.576	2.621	6

Each design reflects a balance between site constraints, climatic conditions, construction budget, energy conservation and solar design features, and client needs, lifestyle and goals. The energy design features for most of the projects consist of the basic elements of envelope insulation, the solar aperture, thermal storage, thermal control, and the auxiliary energy systems. In some designs, hybrid solar heating systems are used. The difference between projects derives from their location and the relative size of these basic elements, such as:

- the size of the solar aperture;
- the organization of the internal volumes and the plan;
- the transmission of the solar radiation directly to the heated space or the absorption and transfer by radiation, convection or conduction;
- the thermal mass, located in the heated space or between the solar aperture and the heated space;
- the kind of selected storage medium; and
- the kind of hybrid system.

While each project design has its own unique set of energy conservation and solar design features, a summary of the major energy saving design features is presented in Table 2 and the paragraphs that follow.

### 1.3 ENERGY DESIGN FEATURES

**1.4 FINDINGS**

The thirteen passive solar projects used, on average, 40 percent less energy for heating than conventionally built residential buildings of the same size. Additional energy savings were achieved through solar domestic water heating, heat recovery to domestic water, and ventilative cooling systems. Year-round comfort in the passive solar homes was, in general, equal to or better than that of conventionally heated or cooled homes. The occupants are very satisfied with the energy savings and comfort of their passive solar homes, and recognize the amenity the passive solar features, such as a sunspace, provide to the overall living quality of the homes.

The high level of thermal performance has been achieved simply and without sacrificing design flexibility and comfort. The key elements of the passive solar design approach that enabled this high level of thermal performance to be achieved are as follows:

1. Proper Site Planning - Solar apertures (windows or active collectors) were protected from unwanted shadows of adjacent buildings or trees during the heating season.
2. Improved Insulation Levels - Generally, a small improvement in wall, ceiling and floor insulation levels over current practice was required to improve the thermal integrity of the building envelope, thus reducing the heating and cooling loads.
3. Greater Air Tightness - Air infiltration was reduced, thus saving energy and improving comfort. A continuous vapor and air barrier, high quality doors and window, careful construction detailing and supervision, and mechanical ventilation with heat exchange for maintaining acceptable interior air quality were commonly employed to reduce air infiltration.
4. Proper Glazing Selection - The choice of glazing type (double, triple, or low "e" ) determined the passive solar potential in each climate (positive window energy balance). Different glazing types were sometimes used for each window orientation to optimize overall building performance.
5. Proper Window Sizing and Location/Orientation - Windows were sized for balanced heating and cooling season performance. Simple redistribution of windows from non-south to southern orientations (in northern latitudes) results in large energy savings at no additional cost.
6. Add Thermal Mass (in lightweight buildings) - Thermal mass, properly sized and located in the building, was used to reduce seasonal heating and cooling loads. Greater solar aperture area requires greater thermal mass area.

7. Properly Shade All Windows - Shading was employed to eliminate or reduce unwanted solar gains during the summer months, thus maintaining comfort.
8. Proper Interior Thermal Zoning - Interior space planning provided for the efficient distribution of passive solar gains in winter and the effective movement of air for ventilation in summer. A whole-house fan and paddle fans were used as an effective cooling strategy for climates where ambient temperature and humidity conditions were favorable.
9. Proper Seasonal Ventilation - Natural or forced whole-house ventilation was used to improve comfort during the overheated periods of the year. Eliminating excessive heat gain through appropriate ventilation strategies is essential to maintaining interior comfort during both the heating and cooling seasons.
10. Efficient Auxiliary Heating and Cooling Systems and Controls - High performance heating, cooling and hot water systems were incorporated into the designs of the energy-efficient passive solar homes.



A brief description of each project is presented in this chapter to summarize the major design features and to facilitate a quick comparison between projects. Table 2 describes the housing type, number and size of units, and the project's passive/hybrid solar design features.

The number at the top of the project summary identifies the location of the project case study in Chapter 3.0.

TABLE 2: PROJECT CHARACTERISTICS

Country	City/Town	Type 1)	No. of units	Unit size (m <sup>2</sup> )	Passive/hybrid solar design features
Austria	Purkersdorf	m.f.	9	130	sunspace
Denmark	Smakkebo	s.f.	55	62,78, 85,97	sunspace, solar water heater
Germany	Berlin	m.f.	31	81,92 125	sunspace (1/2 story), solar collector + storage in floor
Italy	Lana	s.f./m.f.	24	65, 90, 110, 125	direct gain windows
Netherland	Hoek van Holland	s.f.	60	105	solar collector + storage in floor
Norway	Malvik	s.f.	1	140	sunspace, attached
	Lorenskog	s.f.	1	155	sunspace, 2 story
Spain	Mairena del Aljaraf	s.f.	124	90	direct gain windows
Sweden	Stockholm	m.f.	71	65,78 98	atrium, heat storage in ground
Switzerland	Schuepfen	s.f.	36	183	solar collector + heat storage in phase change material
	Wald	s.f.	2	277	sunspace
United States	Boulder, Colorado	s.f.	2	133,146	direct gain windows
	Oakton, Virginia	s.f.	1	313	direct gain windows, interior storage wall

1) s.f.: single family dwelling  
m.f.: multi-family dwelling

3.1 AUSTRIA, Purkersdorf

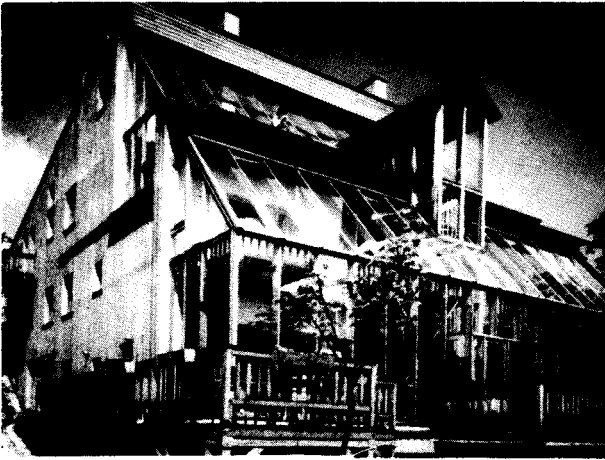

The project consists of two multi-family buildings, located on a gently sloping site in Purkersdorf (about 20 km west of Vienna). The main energy and architectural design feature is a two story sunspace incorporated into each housing unit.

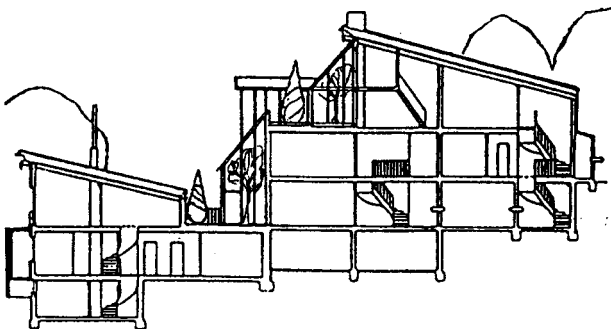

Building A: Cross Section

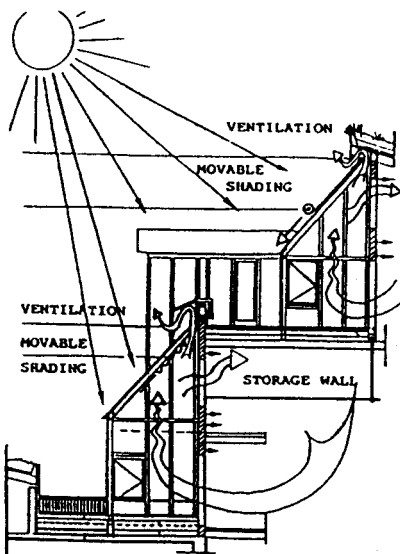

Typical Building Section (Sunspace Building A)

3.2 DENMARK, Smakkebo

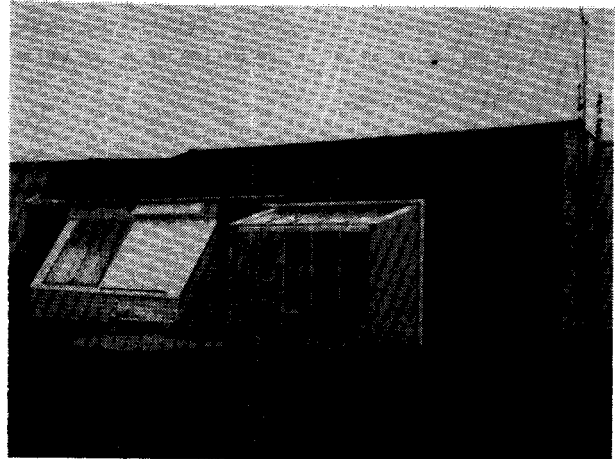

The Smakkebo Building Project comprises 55 dwellings and a common house all designed with the same solar and low-energy features. There are 4 types of dwellings of different sizes, respectively: 62, 78, 85, and 97 m<sup>2</sup>, the smallest being a 1 bedroom, the two middle sizes 2 bedroom, and the largest a 3 bedroom house. The energy design features of the houses include direct gain passive solar heating, high levels of building envelope insulation, mechanical ventilation with heat recovery, and a small sunspace. All houses, except the one bedroom design, incorporate a solar water heating system in the south facade.

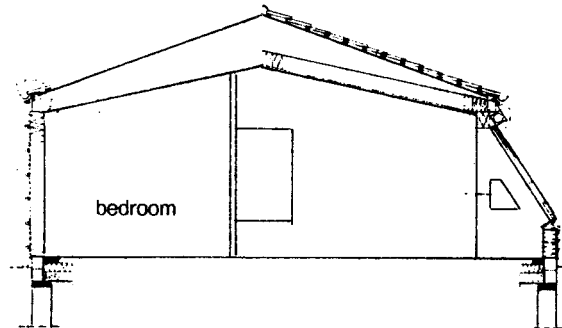

Section

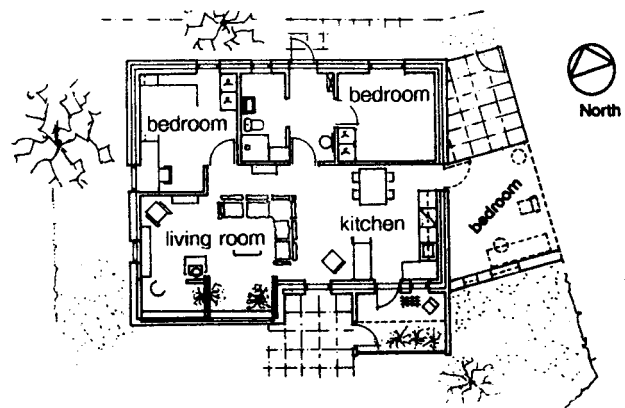

Floor Plan



3.3 GERMANY, Berlin

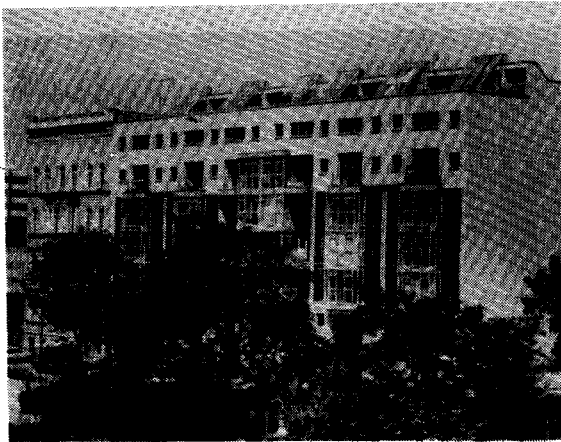

This project is located in a dense urban area of Berlin, within an historical blockstructure. The site faces south to an adjacent street. The building consists of an underground garage with 16 parking places and utility rooms as well as 31 apartments on 7 floors. A variety of passive and hybrid solar features are incorporated into the different unit designs, including direct gain heating, sunspaces, and hybrid heating system.

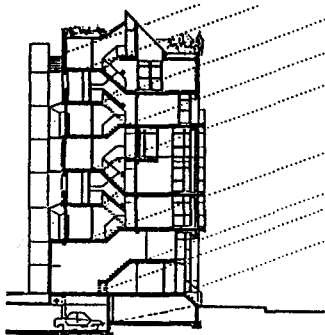

Section A-A

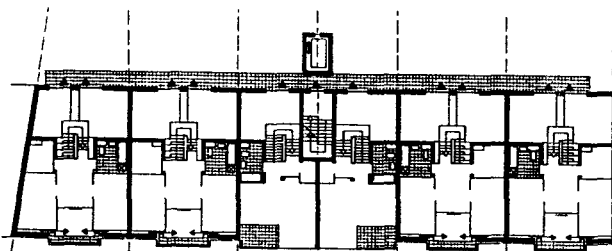

Groundfloor Level 3 1/2 - 4

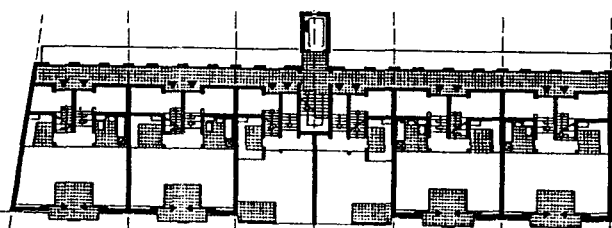

Groundfloor Level 2 1/2 - 3

3.4 ITALY, Lana di Moreno

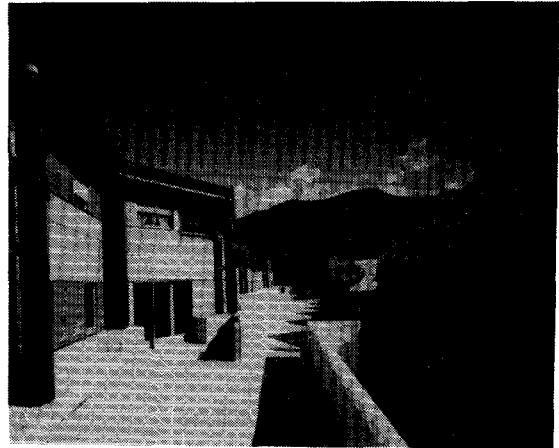

Lana Village is a bioclimatic community system designed for 24 dwellings distributed in a two floor apartment block, and two row house blocks. Ownership is distributed between the local Public Housing Agency and private owners.

The design reduces energy consumption and improves comfort through optimization of the building geometry, building technology, solar features, and controlling the microclimate of the project site.

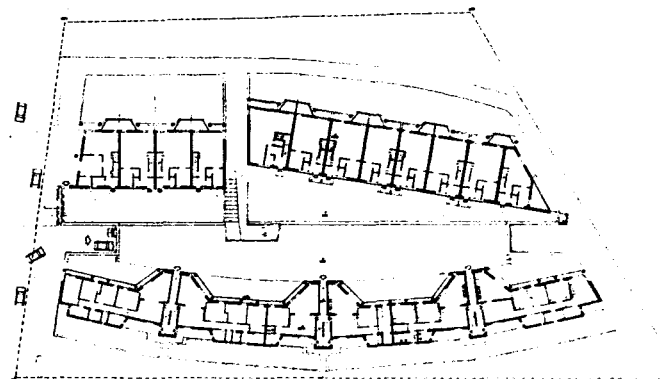

Plan layout

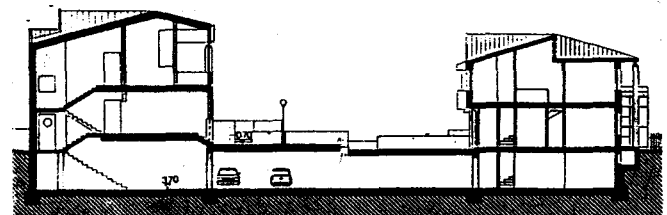

Cross section through the settlement

3.5 THE NETHERLANDS, Hoek van Holland

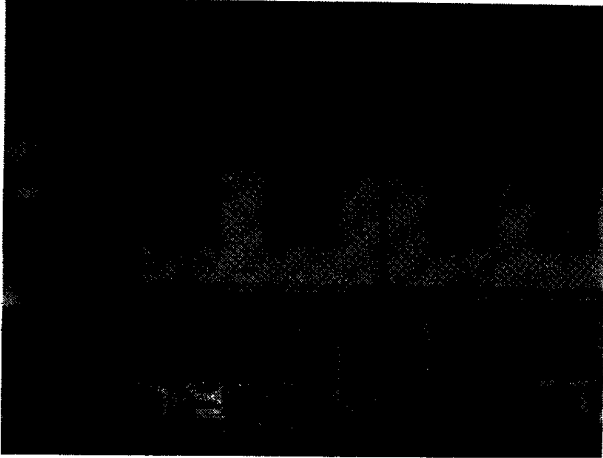

The project consists of 60 small family houses, in rows, which are provided with passive measures to utilize solar energy. The houses are oriented North-South, and are well insulated and draught proof. In 7 houses a hybrid solar energy system has been installed for space heating and water heating. A new type of solar collector, the so-called double airflow collector, supplies heat which is stored in the floor of the first floor and in the hot water boiler.

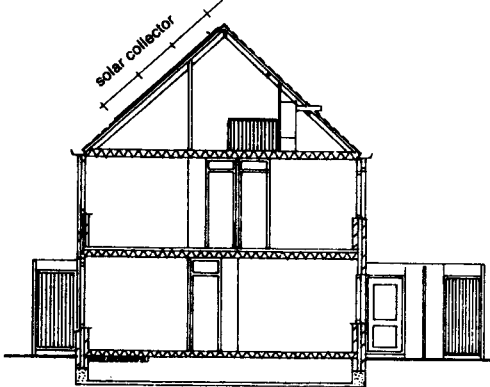

SECTION

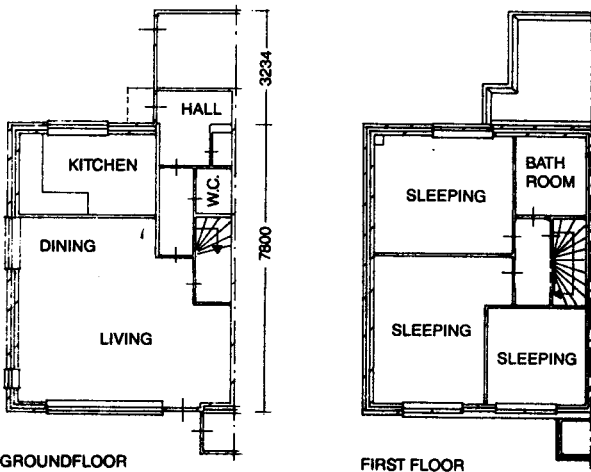

GROUND FLOOR

FIRST FLOOR

3.6 NORWAY, Lørenskog

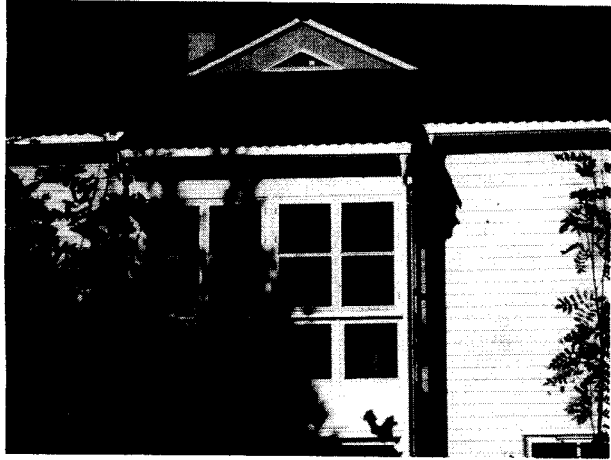

Located near Oslo at Lørenskog, the project consists of a single family, detached dwelling. The small site is within an area of new single family dwellings and multi-family houses. Its main energy design features are a sunspace that acts as a preheater for ventilation air, a heat pump that uses exhaust air to heat domestic water, and super insulation/air tightness.

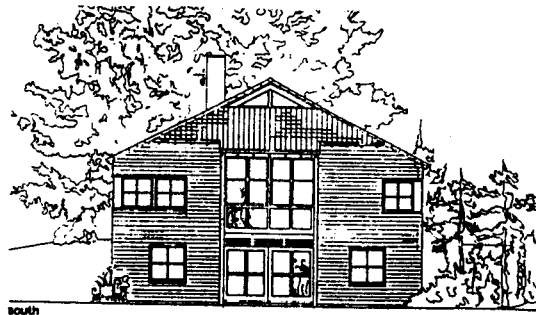

south

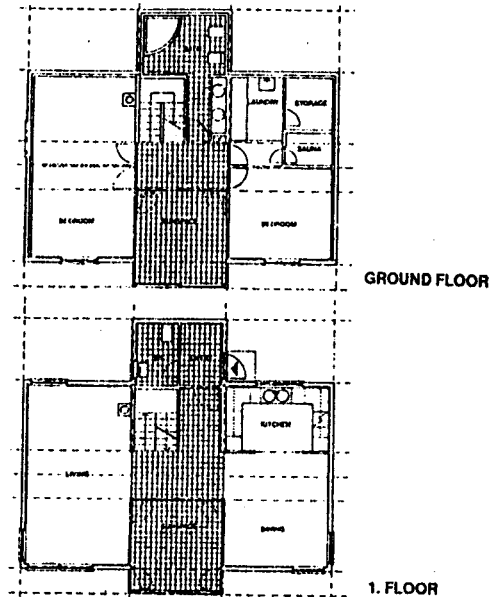

GROUND FLOOR

1. FLOOR

3.7 NORWAY, Malvik

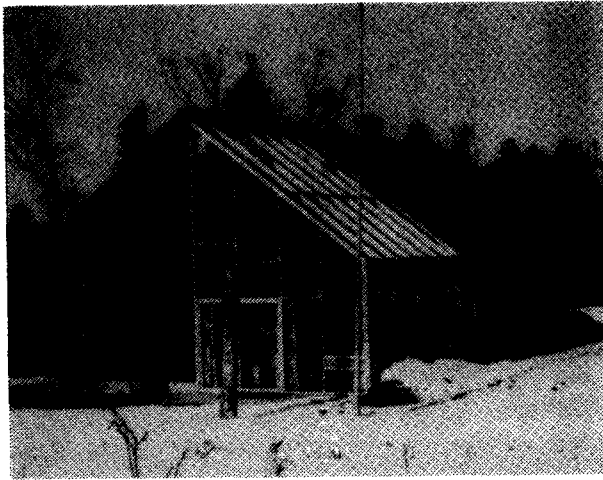

Located on a flat site in Malvik outside Trondheim, the project consists of a single family, detached dwelling. Its main energy design features are a sunspace that acts as a preheater for ventilation air, and a heat pump that uses exhaust air to heat domestic water.

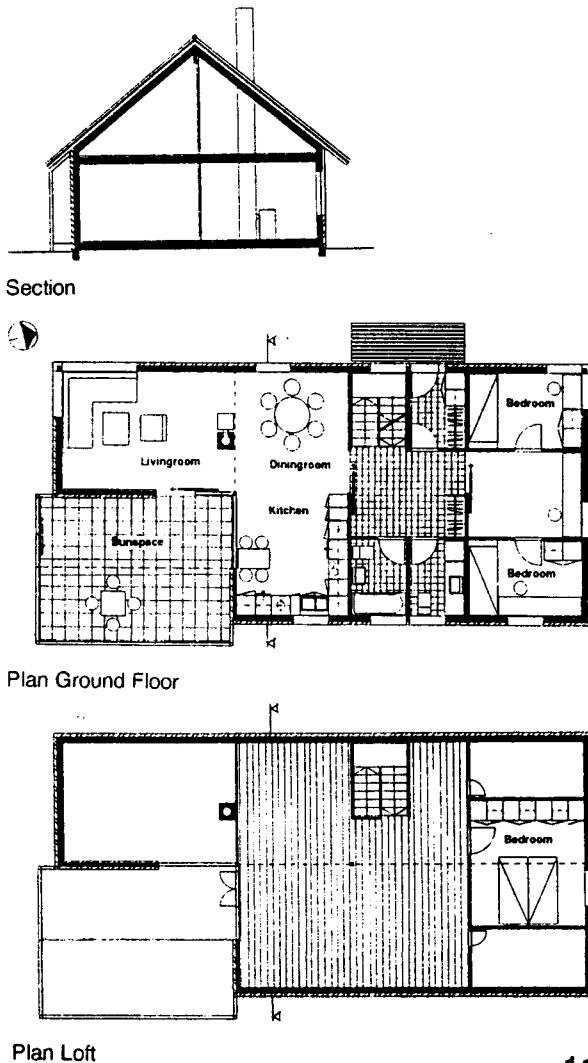

3.8 SPAIN, Mairena Aljarof Sevilla

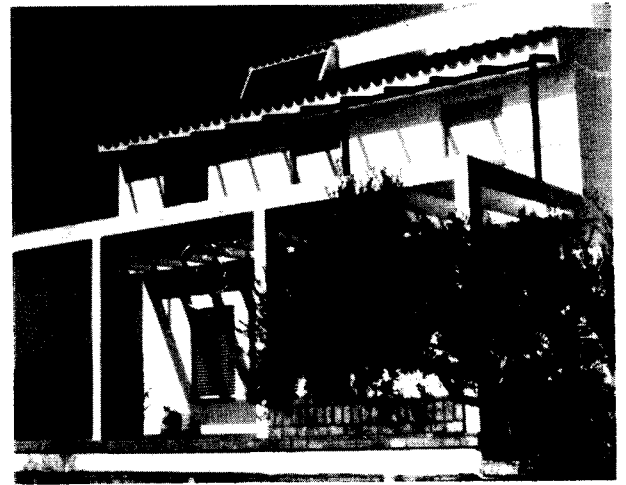

This project is a single family house, with integrated active and passive systems, designed to be responsive in a mediterranean-continental location. The building, constructed under the Spanish Social Housing Programme, (VPO), has stringent conditions on floor area, volume, construction, design and economy. The building is a prototype for a 124-unit complex in Osuma (Sevilla). Direct gain passive solar heating, natural ventilation, and solar water heating are its primary design features.

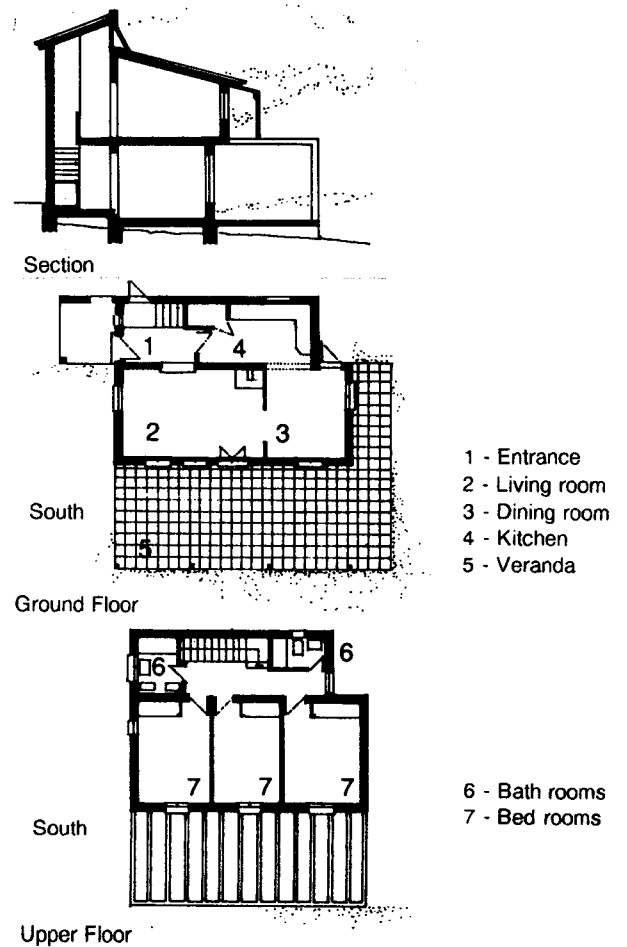

3.9 SWEDEN, Stockholm

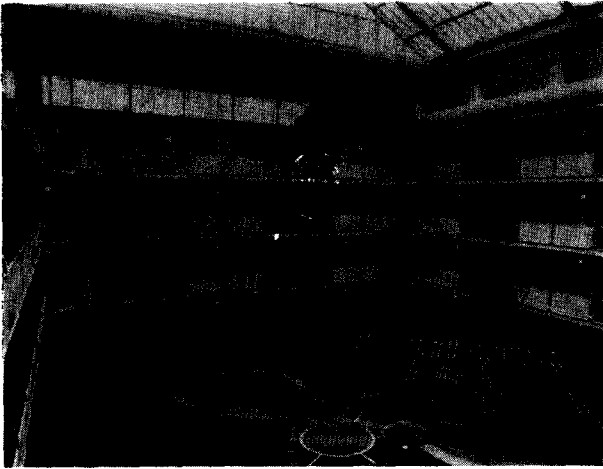

The "Suncourt" project consists of 71 balcony access apartments of which 50 surround a glazed atrium. The building is located on a flat site in Hagsatra, a suburb south of the City of Stockholm. The primary energy design features are: 1. extreme insulation of walls and roof, and 2. heat pump operated cooling of the atrium used for seasonal heat storage in boreholes in the rock below the building.

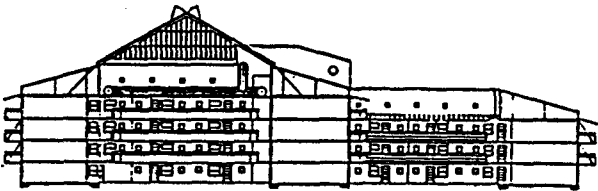

Section

3.10 SWITZERLAND, Wald

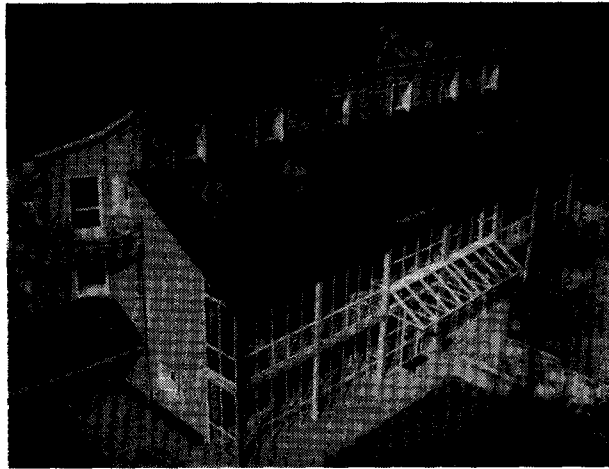

Situated on a steep south-westerly hillside, the building's north wall is completely underground, and the north side of the roof is earth covered. The building is a typical concrete masonry construction with high levels of insulation. The south facade has large glazing areas almost entirely protected by a two story attached sunspace. The sunspace buffers heat loss from the large south glazing area, provides an enlarged unheated living space and delivers direct sunlight and heated air to the living area. Heat can also be fan-forced to the partly heated north zone.

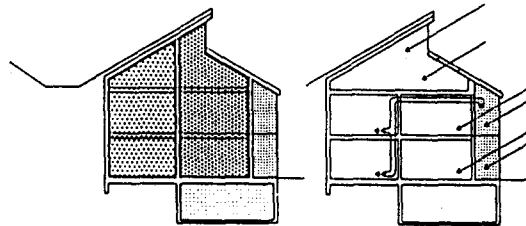

Zoning and solar collection

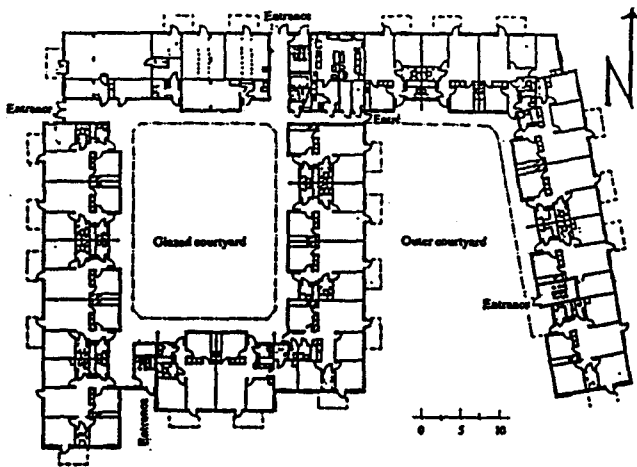

Ground Floor

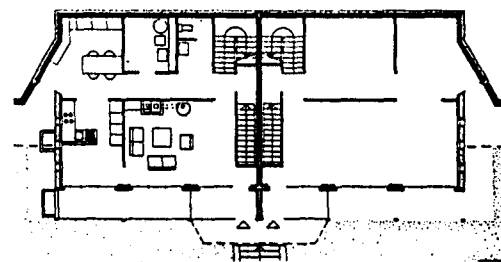

Ground Floor Plan

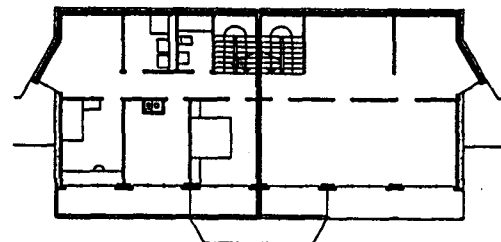

1st Floor Plan

3.11 SWITZERLAND, Schuepfen

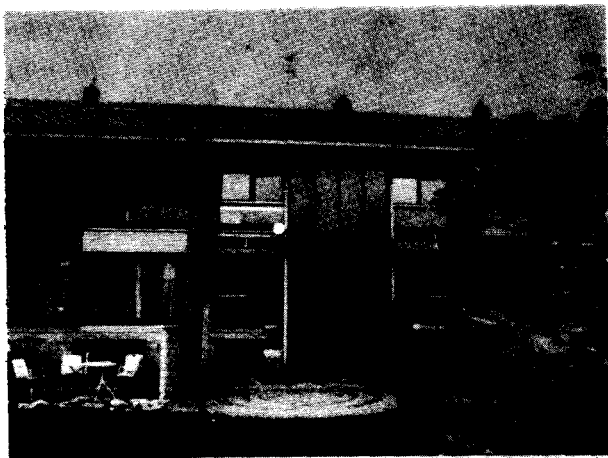

The project consists of 36, 2 1/2 story single family row houses located on a sloping site in Schuepfen, near Bern. The energy design features are direct gain through windows and solar air heating panels integral with the south facade. Direct gain heat is stored in the exposed masonry walls and partitions; collector provided heat is stored in latent storage in a wall in the middle of the house. Sunspaces were also investigated and have been built on several houses in the complex.

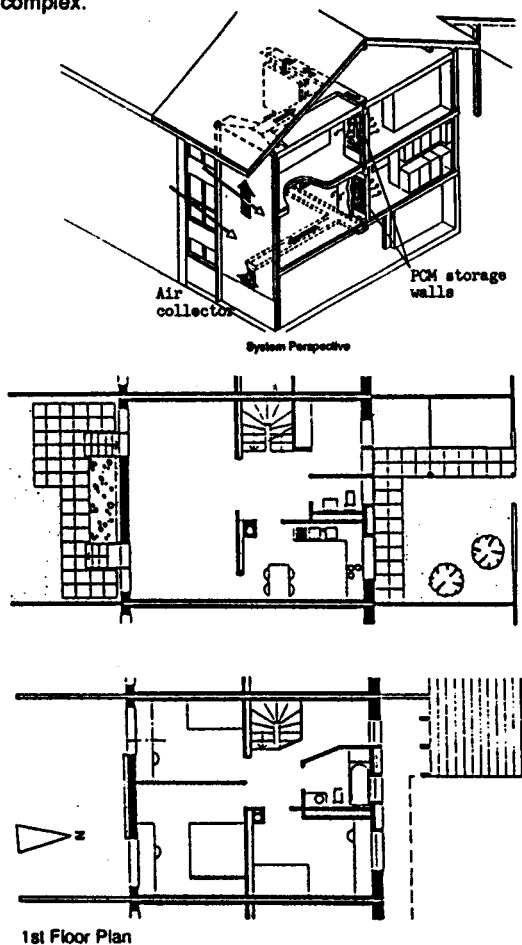

3.12 U.S.A., Boulder, Colorado

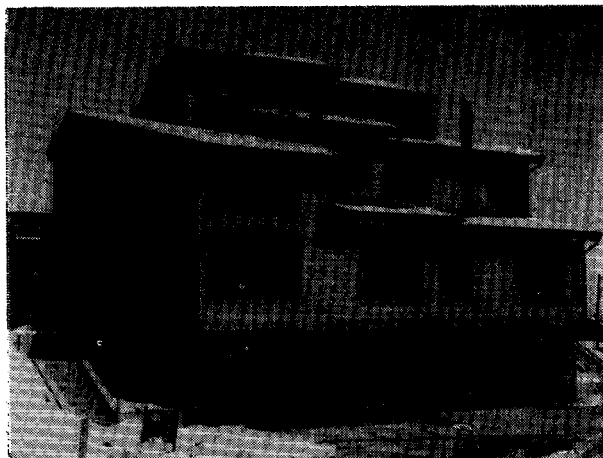

Located on a gently sloping site in Boulder, Colorado, the project consists of two single family attached dwellings, called a duplex. The energy design features are a combination of improved energy conservation through added wall and ceiling insulation and infiltration reduction, plus passive solar gain from south facing windows.

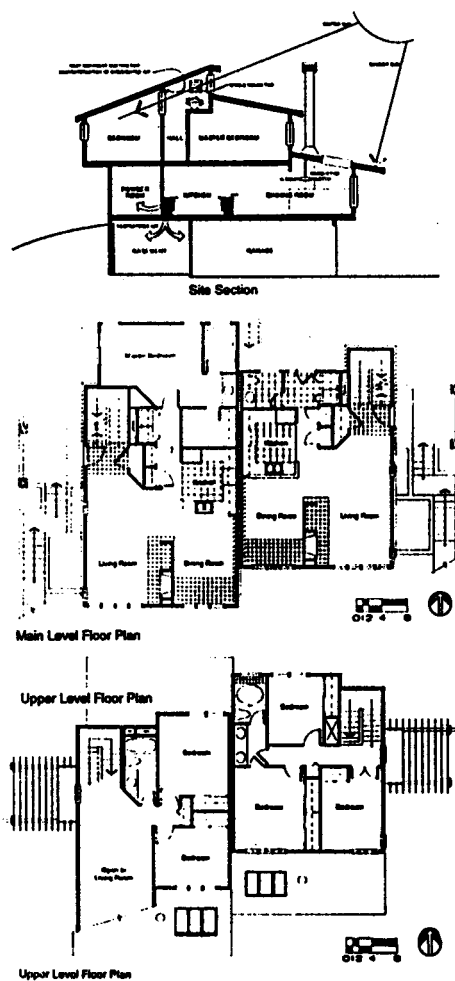

3.13 U.S.A., Oakton, Virginia



The project consists of a single family detached residence located on a sloping site in Oakton, Virginia. The energy design features are a combination of improved energy conservation through added wall and ceiling insulation, infiltration reduction and mechanical system efficiency, and passive solar gain from south facing windows and an interior thermal storage wall.

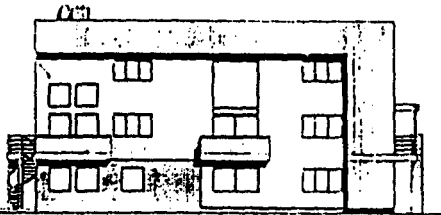

South Elevation

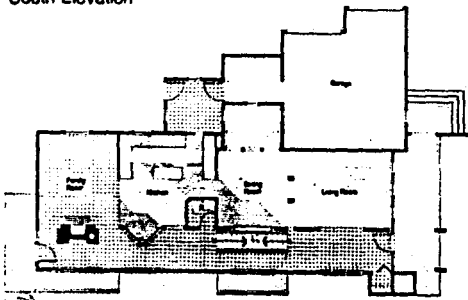

Main Floor Plan

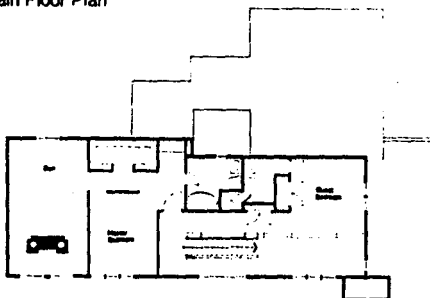

Lower Floor Plan

A full description of the design and performance of the thirteen passive and hybrid solar low energy residential buildings designed, constructed and monitored as part of IEA Task VIII is presented in this chapter. Each case study begins with a brief description of the project, including the participating organizations, project reports, design objectives, location, and climate data. This is followed by an overview of the design focussing on its architectural and energy design features.

Energy analysis performed as part of the design process is described, and comparative analysis between the monitored passive solar house and a simulated reference (conventional) house is presented. Monitoring objectives are defined and a brief description of the monitoring system is presented. Representative hourly or daily performance profiles are included to illustrate the dynamics of the energy design. Results of occupant evaluation are also discussed.

The economic performance of the passive and hybrid solar low energy design features is discussed, including the additional construction costs associated with the energy design features of the house and the cost-effectiveness of these features.

The case study concludes with an overall assessment of the project from an architecture, energy, comfort, and satisfaction point of view.

An important characteristic of each project is the manner in which passive and hybrid solar and energy efficiency features have been combined into an integrated residential energy design solution. A variety of approaches is represented in the case studies. One purpose of the case studies is to illustrate the multiplicity of architectural styles and forms that can be integrated with passive and hybrid solar design concepts.

The reader is encouraged to compare the case studies as a means to understand the genesis of the integrated design solution. This can be done by evaluating case studies from the same climate region or evaluating case studies which employ the same passive or hybrid solar design strategy. Through close inspection and evaluation, it should be possible to derive an initial understanding of the architect's energy design approach. This knowledge may be helpful in developing ones own unique integrated energy design solutions.

The reader is also encouraged to obtain the other booklets in the Design Information Booklet series. Each booklet has been written to provide information helpful in the design, construction, or evaluation of passive and hybrid solar low energy residential buildings.

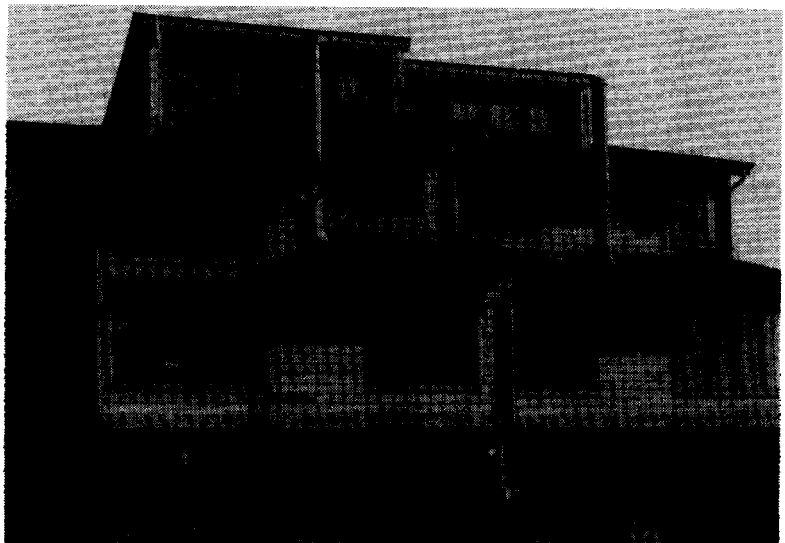



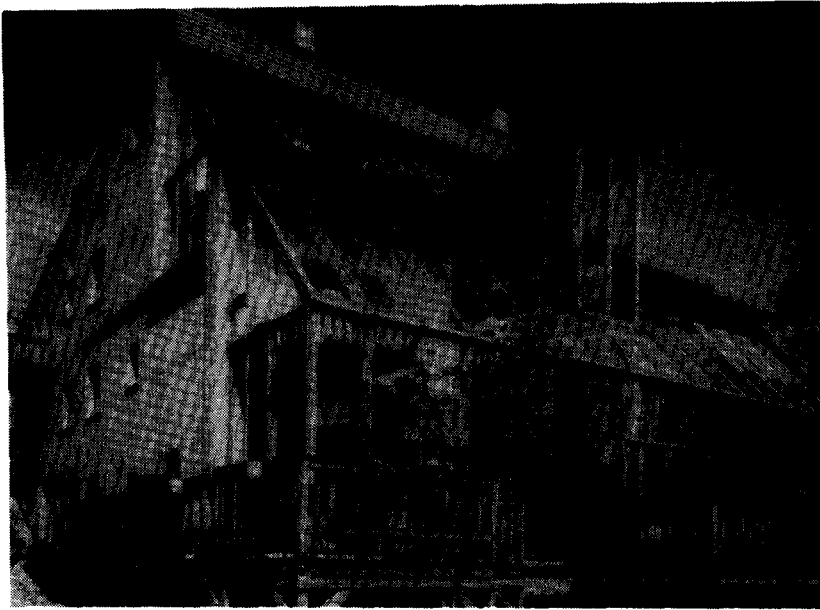

## 1.0 GENERAL

The project consists of two multifamily houses, located on a gently sloping site in Purkersdorf (about 20 km west of Vienna).

**Architect:** G.W. Reinberg  
J. Riesenhuber  
Penzingerstraße 48  
A-1140 Wien

**Contractor:** "Verein Projekt Alternatives Wohnen" e.V.  
3002 Purkersdorf  
Wintergasse 53

**Energy and Monitoring:** W. Hofbauer  
M. Treberspurg  
Penzingerstraße 48  
A-1140 Wien

**Sponsor:** Federal Ministry for Economic Affairs

## 1.1 PROJECT DESCRIPTION

## 1.2 PARTICIPATING ORGANIZATIONS

Documentation of the Purkersdorf Project can be found in the following reports:

Wintergärten

M. Treberspurg, G. Reinberg,  
Holzinformation 4, Wien 1987  
Austria

Solar Architektur

Ein Leitfaden für Studium and Praxis  
M. Bruck, G. Faninger, hpt-Verlag, Wien 1987  
Austria

## 1.3 PROJECT REPORTS

The primary goal of this project was to develop comfortable solar houses with low energy costs and moderate investment costs (approx. AS 13.000 per m<sup>2</sup> living area - excluding real estate - 1 US \$ = AS 13). The project was also intended to create a prototype design for comfortable sunspaces.

## 2.0 CONTEXT

## 2.1 DESIGN OBJECTIVES

## 2.2 LOCATION

The project is located in Purkersdorf, 20 km west of Vienna.

Annual Global Horizontal  
Solar Radiation:

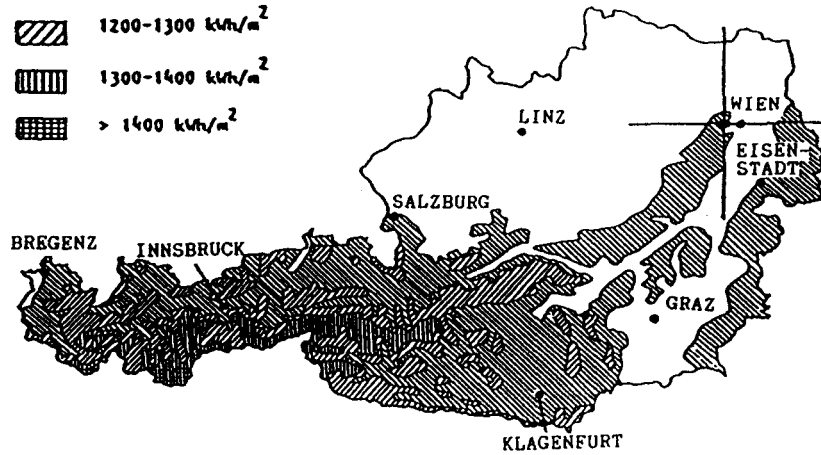
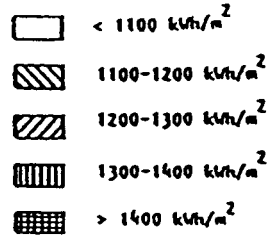

Latitude: 48°12' Longitude: 16°11' Altitude: 246 m

## 2.3 CLIMATE

The map shows annual global radiation sums on the horizontal surface.

The climate of Central Europe is characterized by a cloudy heating season with an ambient air temperature of about 4°C (October - April) and a rather hot and often rainy summer season with an ambient air temperature of about 17°C.

Long term climatic data are shown below:

## MEAN MONTHLY AIR TEMPERATURES (°C)

J	F	M	A	M	J	J	A	S	O	N	D	YEAR
-1,3	0,2	4,4	9,7	14,2	17,7	19,5	18,7	14,9	9,6	4,5	0,5	9,4

## HEATING DEGREE DAYS (Kd) (20°C/12°C)

J	F	M	A	M	J	J	A	S	O	N	D	YEAR
660	555	474	265	88	14	2	4	56	276	462	605	3462

MEAN DAILY GLOBAL RADIATION SUMS (Wh/m<sup>2</sup>)

J	F	M	A	M	J	J	A	S	O	N	D	YEAR(kWh/m <sup>2</sup> )
753	1431	2563	3854	4906	5439	5381	4639	3316	1883	891	550	1120

The two buildings (labeled A and B) are located on a south sloping site. Both are multi-family dwellings (building A: 5 units, building B: 4 units). The living space of a typical unit is about 130 m<sup>2</sup>. The living room is located on the upper level with an attached sunspace to take advantage of the excellent views from the site.

3.0 DESIGN

3.1 ARCHITECTURAL DESIGN

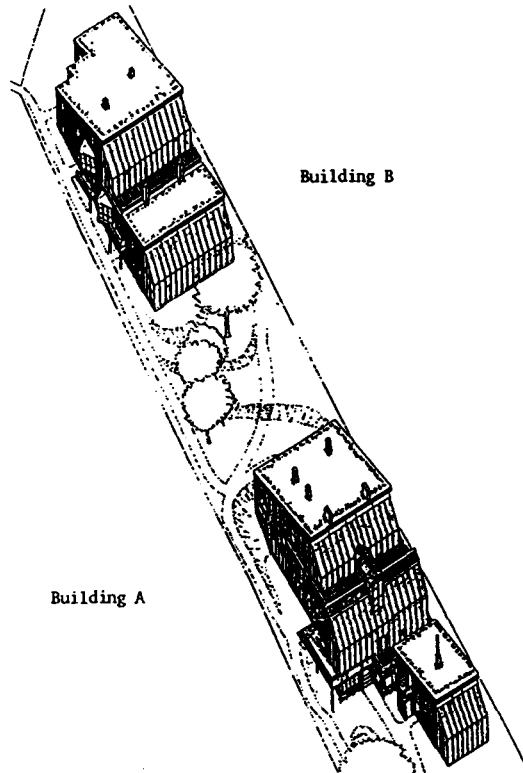

Site Plan

### 3.2 ENERGY DESIGN

The double glazed ( $u = 2,3 \text{ W/m}^2 \text{ K}$ ) south facing sunspaces are shaded by internal moveable shading devices. Ventilation is provided by ventilation lids on the top of the sunspaces. The sunspaces provide a triple benefit; they are part of the passive heating system, they provide a considerable daylighting benefit and they provide additional living area for the house.

The insulation level of the roofs is achieved using an insulation foam (Polystrol); the R-value is  $2,45 \text{ m}^2 \text{ K/W}$ . The R-value of the exterior walls is  $2,65 \text{ m}^2 \text{ K/W}$ . Considerable efforts have been undertaken to avoid thermal bridges.

Space heating and domestic hot water is provided by a central gas heating system (water distribution). Space heating peak demands are covered by individual electric heaters. The installed heating and DHW capacity is  $11 \text{ kW/unit}$ .

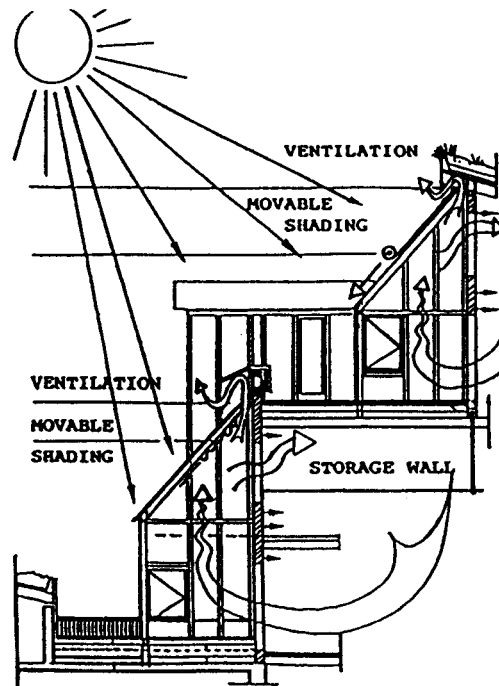
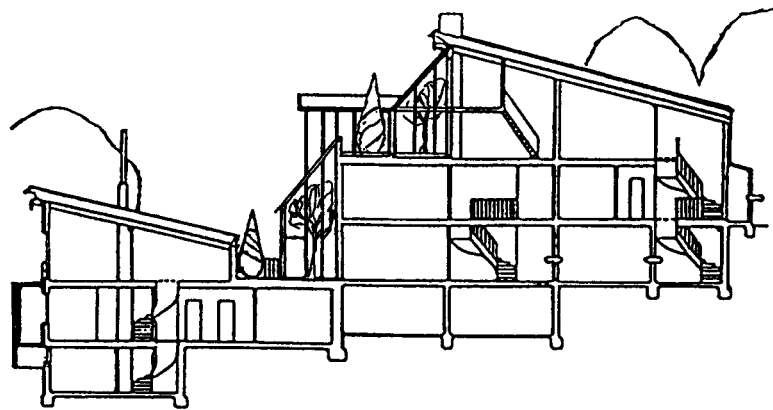

Building A: Cross Sections

Mean monthly temperatures as well as minimum and maximum temperatures in the sunspace have been calculated.

#### 4.0 ANALYSIS

Mean monthly predicted air temperatures in the sunspace (heating season) are listed below:

<b>October</b>	<b>20,48 °C</b>
<b>November</b>	<b>13,39 °C</b>
<b>December</b>	<b>9,25 °C</b>
<b>January</b>	<b>8,23 °C</b>
<b>February</b>	<b>11,73 °C</b>
<b>March</b>	<b>18,71 °C</b>
<b>April</b>	<b>24,11 °C</b>

Minimum temperature in the sunspace (-15°C ambient air temperature, no radiation): -6,9°C

Maximum temperature in the sunspace (30°C ambient air temperature, global radiation flux on the horizontal surface: 850 W/m<sup>2</sup>): +43,3°C

The predicted (Design tool: EBIWAN) energy balance of a typical unit during the heating season is as follows:

<b>Transmission losses:</b>	<b>12.500 kWh</b>
<b>Ventilation losses:</b>	<b>10.000 kWh</b>
<b>Utilized solar gains:</b>	<b>5.300 kWh</b>
<b>Utilized internal gains:</b>	<b>2.580 kWh</b>

#### 5.0 MONITORING

The monitoring objectives for the "Purkersdorf Project" are to:

- o **assess the comfort conditions of the sunspace; and**
- o **assess the annual fuel cost savings of a "passive solar house" compared to a conventional dwelling**

#### 5.1 MONITORING OBJECTIVES

#### 5.2 MONITORING SYSTEM

By means of a computerized data logger and sensors the following parameters were measured:

- 1 **global radiation on horizontal surface**
- 2 **global radiation on front surface of the sunspace**
- 3/4 **wind velocity**
- 5 **ambient air temperature**
- 6 **humidity**
- 7 **air temperature in the sunspace**
- 8 **air temperature in the living room**
- 9 **air temperature in the children's room**
- 10 **surface temperature, sunspace exterior surface**
- 11 **surface temperature, sunspace inner surface**
- 12 **surface temperature, sunspace storage wall**
- 13 **surface temperature, living room storage wall**
- 14 **surface temperature, wood ceiling**
- 15 **grass roof temperature below insulation**
- 16 **grass roof temperature above insulation**
- 17 **grass roof temperature about 1 m below surface**
- 18 **hot water consumption**
- 19 **heat consumption for space heating**

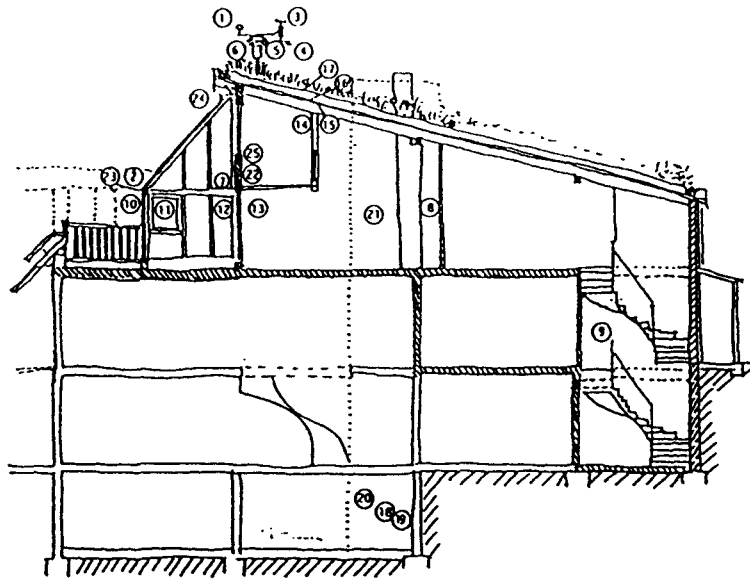

Monitoring: Location of Sensors

5.3 PERFORMANCE RESULTS

The measured energy balance of a typical unit during the heating season 1985/86 is as follows:

Transmission losses:	10.600 kWh
Ventilation losses:	8.500 kWh
Utilized solar gains:	6.200 kWh
Utilized internal gains:	2.500 kWh

The monitored results are in good agreement with simulated results as shown in the following figure. The overall energy saving of the passive solar home compared to a conventional home is about 7.000 kWh.

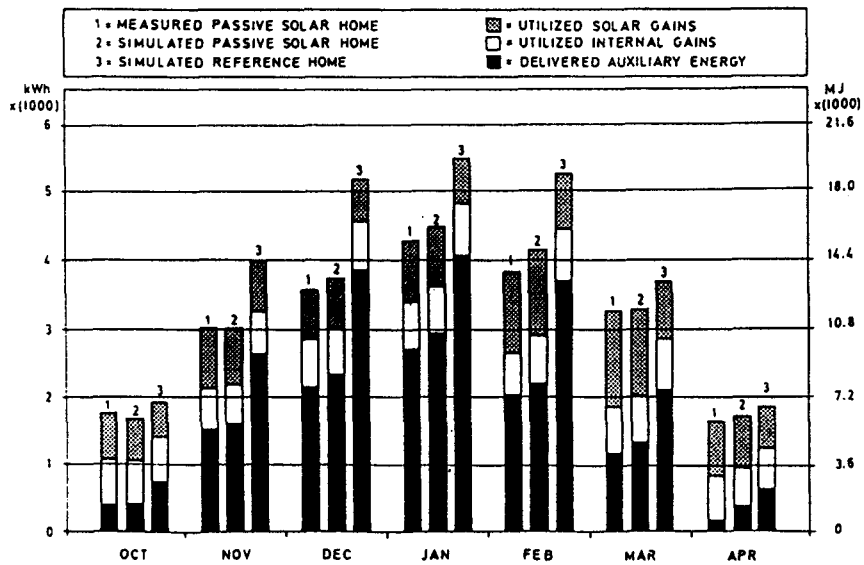

Monthly Space Heating Loads 1985/86

Recorded temperature profiles for some typical weather situations are shown in the following figures.

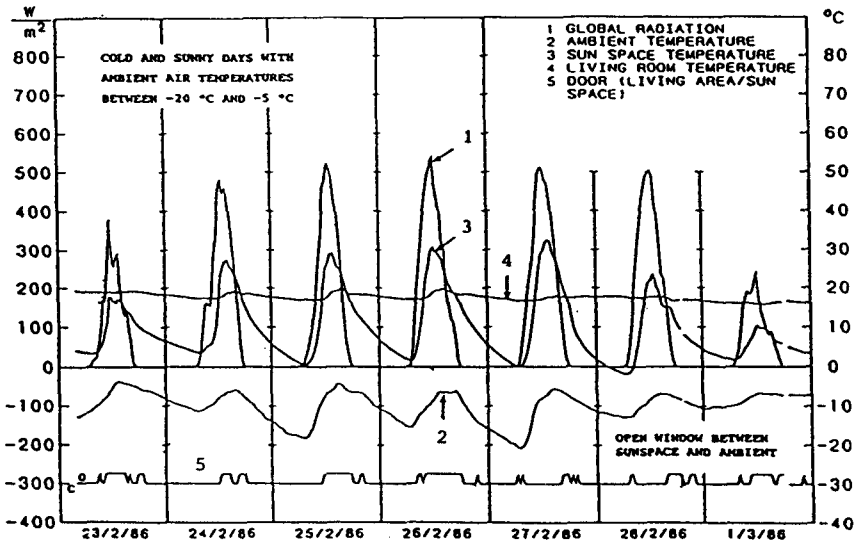

Typical Temperature Profile (Clear Winter Day)

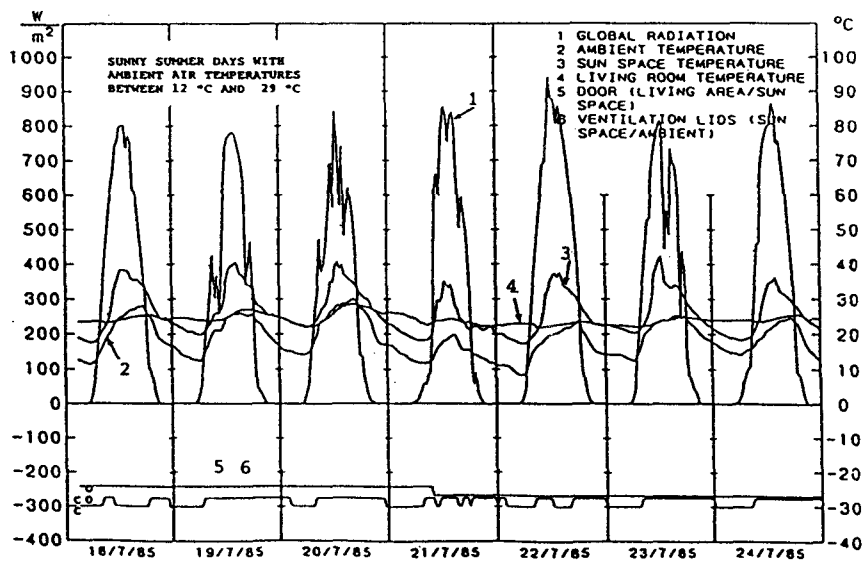

Typical Temperature Profile (Sunny Summer Day)

#### 5.4 OCCUPANT EVALUATION

The building occupants view the sunspace as primarily an amenity - added space and improved living environment - and secondarily as an instrument for energy production. Therefore, all sunspaces are intensively used as part of the lifestyle of the occupants. The sunspace- "living room" cannot be used throughout the year (which is fully accepted by the occupants) but it offers extraordinary living quality and special experiences:

- The seasons can be experienced in a better way, even with a "reduced living room" in extreme winter.

- The rhythm of the day and the weather can be experienced more consciously (changes of temperature exceeding the usual range of comfort are accepted).

- The sunspace can be given a "semi-public" character, as an intermediate area between private living room and "public" garden, or as a common room for several families. This utilization, however, largely depends on the respective user.

#### 6.0 ECONOMICS

The added construction cost of the sunspace was 98.600,- (AS) including 20 % VAT (US\$ 7.585,- -1 US\$ = AS 13). However, due to the higher market value of the passive solar home, the profit margin compared to conventional houses is approximately 25 %.

##### 6.1 ADDITIONAL CONSTRUCTION COST

##### 6.2 COST EFFECTIVENESS

According to experience, the sunspace is used as an additional living space provided the sunspace temperature is in the range +15°C to +25°C. Therefore, according to the measured annual temperature distribution, the sunspace may be considered as a "60 % living space". Consequently, only 40 % of the additional construction costs are considered as the cost increment of the sunspace.

The fuel cost savings are about AS 2.700,- per year (US\$ 208,-); the simple pay back period (cost increment divided by the net money savings in the first year) therefore is:  $40000/2700 = 14.8$  years.

#### 7.0 CONCLUSION

The Purkersdorf Project demonstrates that the sunspace is fully accepted as an additional living space, although the fuel cost savings - due to low energy prices - are not significant.



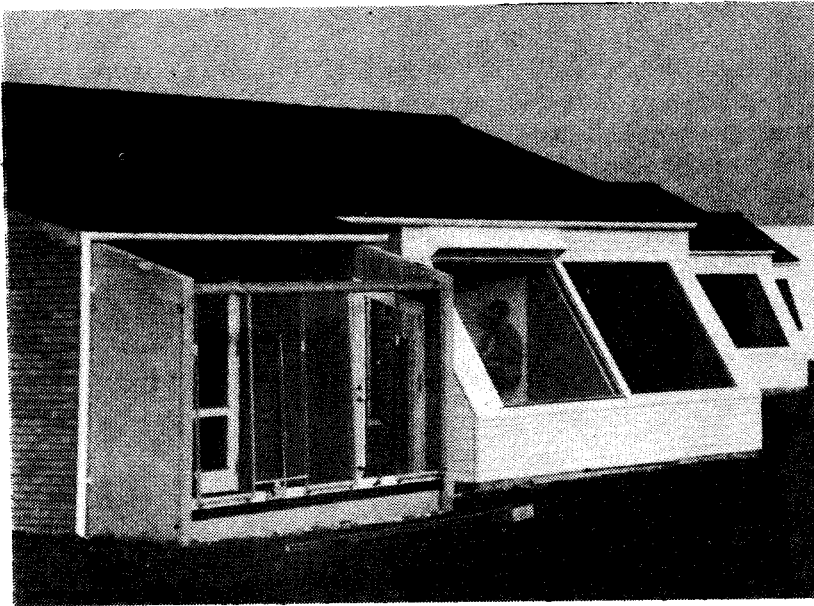

## 1.0 GENERAL

The Smakkebo Building Project comprises 55 dwellings and a common house all designed with the same solar and low-energy features. There are 4 types of dwellings of different sizes, respectively: 62, 78, 85, and 97 m<sup>2</sup>; the smallest being 1 bedroom; the two middle sizes, 2 bedroom; and the largest a 3 bedroom house. The energy design features of the houses include direct gain passive solar heating, high levels of building envelope insulation, mechanical ventilation with heat recovery and a small sunspace. All houses, except the one bedroom design incorporate a solar water heating system in the south facade.

## 1.1 PROJECT DESCRIPTION

**Architect :** Jørgen Andersen  
Mørdrupvej 99  
3060 Espergårde

**Client :** Boligfonden SDS  
Meldahlsgade 32  
Vesterport  
1613 Copenhagen K

**Energy Consultant:** Cenergia ApS  
Stationsvej 3  
2760 Måløv

**Contractor:**  
Hoffmann & Sønnen A/S  
Maltegårdsvej 24  
2820 Gentofte

**Services Engineer:** E. Troelsgaards Tegnestue,  
Overgaden Neden Vandet 49  
1414 Copenhagen K

**Sponsors:**  
Danish Ministry of Energy,  
The Danish Building Industry Development Board  
and The Council of Technology

**Monitoring Organisation:** Thermal Insulation Laboratory,  
Technical University of Denmark  
Bld. 118, 2800 Lyngby

## 1.2 PARTICIPATING ORGANIZATIONS

Documentation of the Smakkebo Project can be found in the following reports:

## 1.3 PROJECT REPORTS

The IEA Project - Smakkebo. Documentation of Design, Construction, Monitoring Programme. Ove C. Merck  
Thermal Insulation Laboratory, Technical University of Denmark, May 1988.

EDB-Programmer til beregning af passiv solvarme.  
Jargon E. Christensen.  
Thermal Insulation Laboratory, Technical University of Denmark, October 1987.

IEA Projektet Smakkebo. Ove C. Merck, Peder VeJsig Pedersen,  
Jargon E. Christensen, Jargon Andersen,  
The Danish Building industry Development Board, May 1989.

**2.0 CONTEXT**

**2.1 DESIGN OBJECTIVES**

The primary objectives of the Smakkebo project were to demonstrate that solar low-energy techniques can be successfully implemented in the Danish housing industry in a cost-effective way without adding any limitations to the quality of the architectural design; and to verify the effectiveness of these techniques by carrying out a detailed monitoring programme.

**2.2 LOCATION**

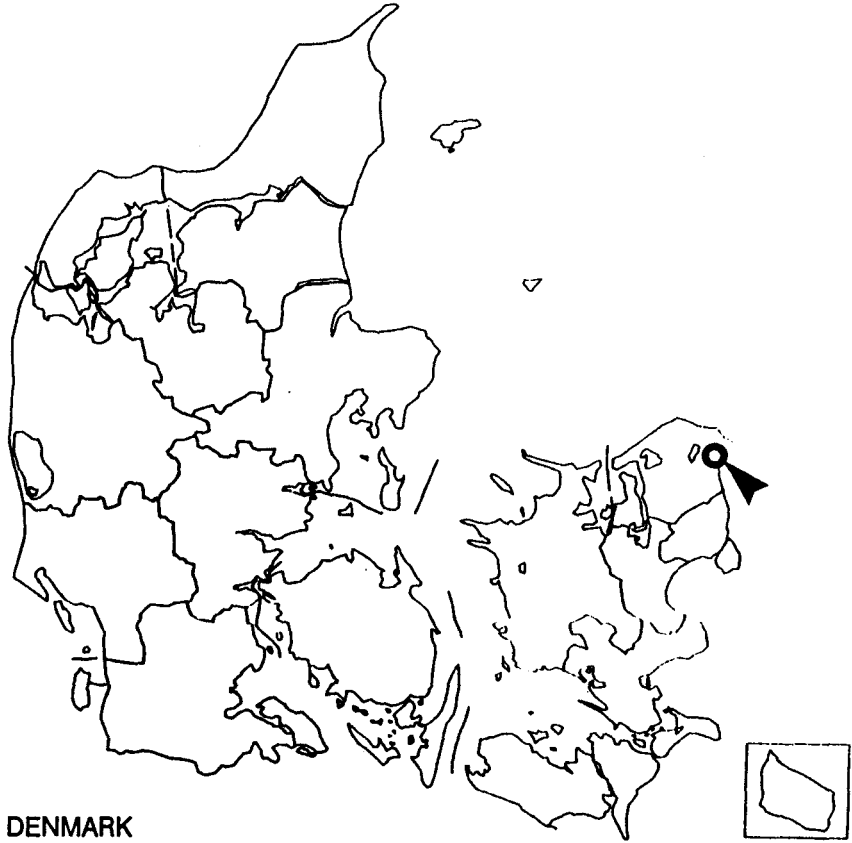

DENMARK

**Latitude: 55 N Longitude: 12 E Altitude: 10 Meters Above Sea Level**

**2.3 CLIMATE**

The Smakkebo project is located at a site in the outskirts of Helsingør in the Northern part of Zealand. The site is surrounded by one-and two-story houses and because of site topography it is fairly exposed to wind and sunshine. There is no shelter from trees and the houses are placed more than a minimum distance apart in order to avoid mutual shading. The climate, which varies little throughout Denmark, is coastal with mild winters and relatively cool summers. Long term climatic data for Denmark are shown below.

Average Annual Temperature.....8.0 °C	Design Days...(17 °C Base)..3091 HDD
Average Winter Temperature.....2.4 °C	Global Irradiation.....3676 MJ/m <sup>2</sup>
Average Summer Temperature..12.8 °C	Diffuse Portion.....47%
Average Annual Relative Humidity..84%	Sunshine Hours.....1570

The architectural programme called for the design of 55 single family, detached or semi-detached dwellings of various sizes from 62 to 97m<sup>2</sup>, and a common house of 124 m<sup>2</sup>. The client, Boligfonden SDS, initiates and administers the design and construction process of so-called cooperative building projects, which are built and financed according to Danish governmental regulations. This implies rather severe size and cost restrictions on the design.

### 3.0 DESIGN

#### 3.1 ARCHITECTURAL DESIGN

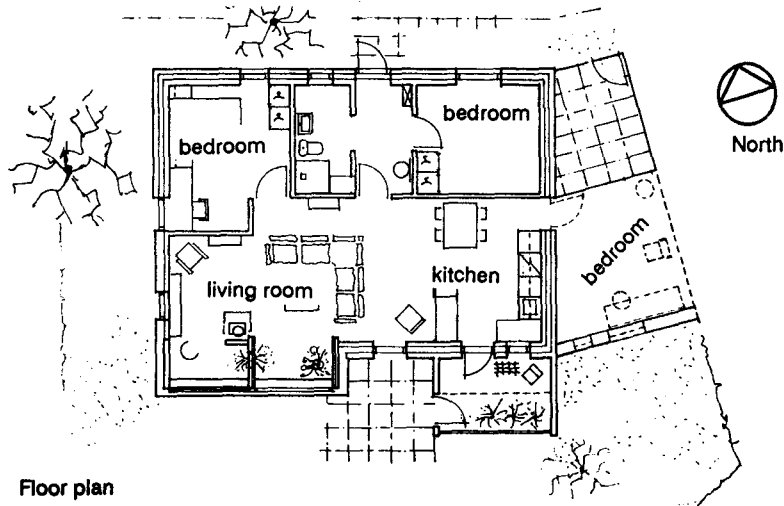

Floor plan

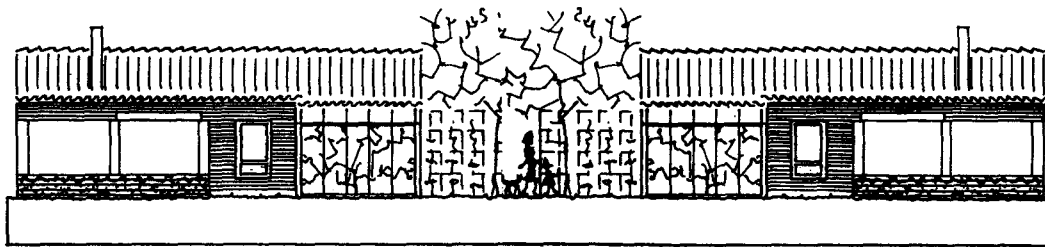

South elevation

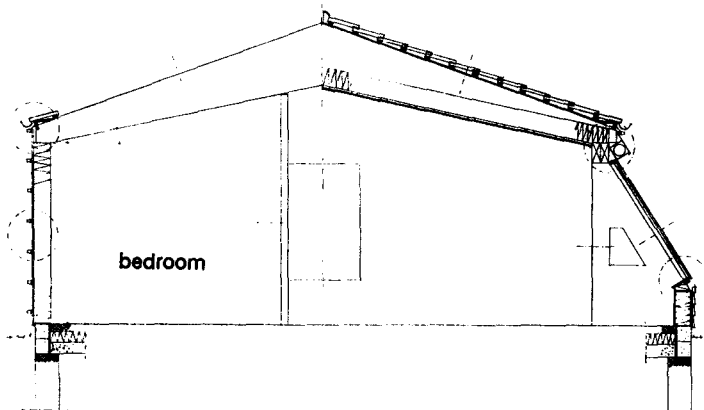

Section

**3.2 ENERGY DESIGN**

The energy saving design features comprise a mix of solar and energy conservation measures. The houses are primarily oriented towards south (15 degrees towards east or west) and the Direct Gain design is emphasized by the large sloping window on the south facade. The insulation thicknesses have been increased as much as was technically/economically feasible and the heat content of the ventilation air is recovered. Windows are triple glazed except for the large, sloped window which has been equipped with an outside roller shutter for solar control and nighttime insulation. A small sunspace is attached to the south facade in front of the kitchen and an innovative solar hot water system has been integrated in the south facade.

Design details of solar and energy conservation features are described below:

**DIRECT GAIN  
WINDOWS**

62 % of the window area is oriented towards the south, and the interior walls, made of concrete or leca-concrete provide thermal mass. One large window slopes at an angle of about 60 degrees for maximum sunlight in the heating season.

**IMPROVED INSULATION**

The transmission losses of the houses have been reduced compared to the Danish Building Regulations by increased insulation thicknesses. U-values range from 0.13 to 0.2 W/K/m<sup>2</sup>. Except for the large sloping window, all windows are triple glazed.

An air-to-air, high-efficiency, countercurrent heat-exchanger has been installed to recover the heat of the ventilation air.

**HEAT RECOVERY**

The large, sloping window is equipped with an outside roller shutter having two functions. During winter it can be used during nighttime as an insulating shutter and in summertime it can be used to prevent overheating of the house.

**SHUTTERS****ATTACHED SUNSPACE**

A small sunspace is located at one end of the house outside the kitchen. The sunspace reduces heat losses from the part of the facade it covers and provides a pleasant "almost outdoor" feeling to the user. The sunspace has two layers of glass and can be used on sunny days during the heating season.

**SOLAR WATER HEATER**

An innovative solar hot water system has been integrated in the south facade next to the sloping window. The absorber and the storage tank of this thermosyphon system have been combined into one unit, which can be used as a wall element.

**CONSTRUCTION**

The load bearing walls of the houses are prefabricated sandwich-concrete elements with 18 cm of mineral wool in the middle. The internal walls are medium-weight leca-concrete prefabricated elements. The foundation is lined with 75 mm mineral wool and the floor consist of a concrete slab resting upon 22 cm of leca-nuts (hard-burned "leca"-clay), with a parquet floor on top insulated with another 75 mm of mineral wool. The houses are covered with a 20 degree pitched timber roof with black, corrugated fibre-cement sheeting. The section shows how the pitch appears also in the inside, with a somewhat lower slope. The roof is insulated with 25 cm of mineral wool. Special attention has been given to weather-stripping, resulting in a natural infiltration rate as low as 0.06 ach.

The houses are equipped with electrical baseboard heaters in all rooms except for the entrance hall and the bathroom which have an electrically heated floor. It is possible to install an electrical heating element in the inlet of the ventilation systems and a number of the tenants have done so. These heating elements are controlled by a traditional temperature setpoint on/off controller with a dead-band of 1-2°C. A central night set-back or intermittent heating controller, allowing the temperature setpoint to be lowered by 5°C is provided in each house.

#### AUXILIARY SYSTEM AND CONTROLS

The ventilation system with heat-recovery can be manually controlled to three different rates according to the needs of the occupants. The lowest rate is the basic ventilation level required by the building code, the second provides a somewhat increased ventilation and the high rate is for heavy cooking.

The solar hot water system has a temperature setpoint control for the electrical heating element placed in top of the storage tank.

As part of the design process, the energy consumption for heating and hot water was calculated and compared to that of a reference building designed according to the Danish Building regulations. The predictions showed an auxiliary energy consumption for heating of about one third of that of the reference building and a solar fraction of approximately 50% for hot water production.

#### 4.0 ANALYSIS

The primary objective of the Smakkebo project was to demonstrate that solar low-energy techniques can be successfully implemented in the Danish housing industry in a cost-effective way without adding any limitations to the quality of the architectural design. A second objective was to verify the effectiveness of these solar low-energy techniques by carrying out a detailed monitoring programme.

#### 5.0 MONITORING

##### 5.1 MONITORING OBJECTIVES

The monitoring includes a combination of continuous, detailed performance measurements and gross energy consumption data. One dwelling was selected for the detailed measurements. A total of 45 sensors including 5 weather data sensors were scanned each minute and the data recorded at half-hour intervals. In each house the total amount of electricity consumed by the auxiliary heating system was recorded by a separate watt-hour meter, which was read once a week. The total electricity consumption was measured by a utility watt-hour meter and likewise read each week.

##### 5.2 MONITORING SYSTEM

A simple hour-counter was used to count the number of hours in which the heating element in the hot water storage tank was activated. Knowing the power consumed by the heating element, the calculation of auxiliary electricity for hot water preparation was straight-forward. The counter was read once a week.

Readings were performed by the tenants themselves, using formatted sheets allowing comments on the use of the house, indoor temperatures, vacations and other comments. The sheets were compiled once a week by a teenager living in the community. This procedure worked remarkably well during the 1 1/2 years of monitoring.

### 5.3 PERFORMANCE RESULTS

The houses were monitored during the winter 1985-1986. Unfortunately, this winter had only 76 % of the sunshine of an average Danish winter and an average outdoor temperature which was 1.5 °C below normal (corresponding to 10 % more degree days). Also, the availability of free heat was less than expected in the design phase.

By comparing performance predictions based on actual conditions with those calculated during the design phase, it is possible to determine the influence of weather conditions and of free heat from lights and electrical appliances. The impact of these actual conditions is illustrated in figure 1.

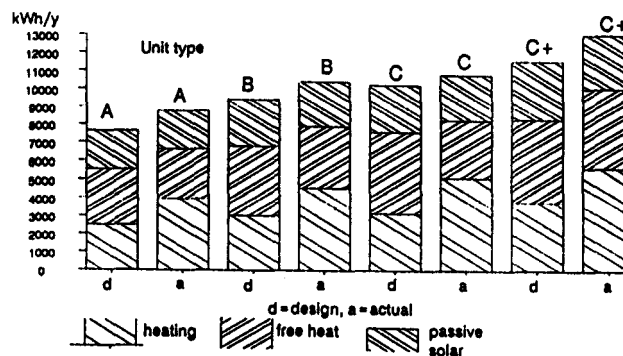

FIGURE 1 Calculated Energy Balances, design versus actual conditions. The total column height represents total building losses.

From figure 1, it is seen that the thermal losses from all unit types (A,B,C,C+) are greater due to the colder weather. As the contributions of free heat and passive solar energy are also considerably smaller, the net result is an increase in heating energy consumption of approximately 2000 kWh for the heating season.

On average, the houses consume more heating energy than anticipated. The reason this occurred is illustrated in figure 2, which shows the calculated energy balance compared to the measured average. The latter has been

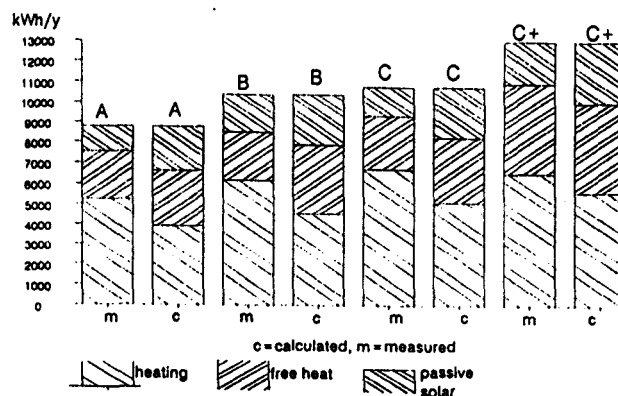

FIGURE 2 Measured and Calculated Energy Balances on Actual Data. The total column height represents total building losses.

determined from statistical correlations. It is seen that the utilization of free heat gain and passive solar energy is less in the measured average houses, than in the ideally performing calculated houses. Analysis of the detailed monitored data indicates that the houses do have the potential of performing closely to the expectations, which several houses do. Therefore, it must be concluded that the poorer utilization of free heat gains and passive solar energy is due to occupant behavior. This conclusion is supported by observations at the site: On cold, sunny days in February and March, the outside shutters in front of the large sloping windows have often been seen half way down, effectively blocking useful solar energy gains.

The histogram in figure 3 show the spread in heating energy consumption in different houses. It is seen that the users influence by approximately +/-35% from the average. The house which was monitored in detail used 16% less heating energy than average houses of the same type.

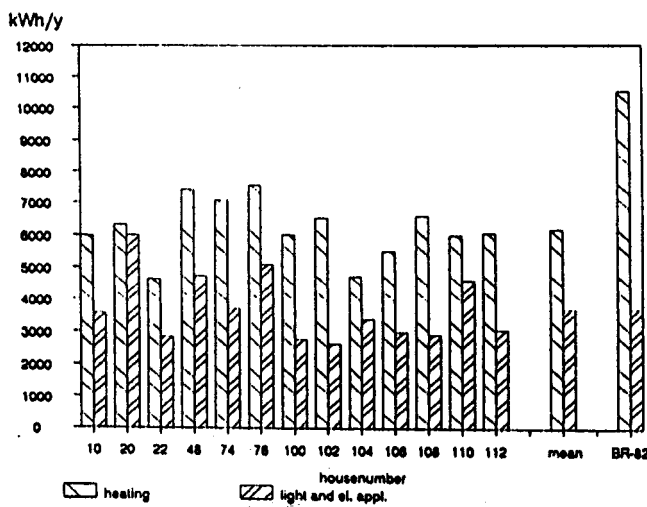

FIGURE 3 Energy Consumption in B-type Houses for Heating and Electricity

The reference case BR-82, for the comparisons shown above, is a theoretical house and the heating energy consumption is calculated without taking the user influence for this house into consideration. In the table below the heating energy consumption of the Smakkebo houses are compared to average measured heating energy consumption for 3300 Danish houses building according to the Danish Building Regulations. From the table, it is seen that the Smakkebo houses on average consume between 56 and 62% less energy for heating, than a typical Danish house.

	kWh/m <sup>2</sup>	%
Measured BR-82: (average of 3300 houses)	125	100
Smakkebo:		
Type A	55	44
Type B	56	45
Type C	53	42
Type D	47	38

#### 5.4 OCCUPANT EVALUATION

Generally, the tenants find the houses provide a pleasant to a very pleasant indoor thermal climate. The natural lighting level is very satisfactory, the air quality is high, though sometimes the air seems to be a bit dry. Also, some of the tenants occasionally find noise from the ventilation system to be too loud. All tenants make use of the control possibilities: temperature set-back during nighttime, shutter operation and ventilation system operation. And, all tenants claim to open the door to the sunspace, whenever solar heat is available. Generally speaking, the tenants express great satisfaction with their houses.

### 6.0 ECONOMICS

#### 6.1 ADDITIONAL CONSTRUCTION COSTS

As the houses have been built according to special Danish regulations for cooperative building projects, total building costs had to be within given limits to obtain financing. These limits were only slightly extended because of the energy saving nature of this project. The project received standard Danish energy saving promotional financial support. This amounted to approximately 15000 Dcrs per house. The actual cost of the passive solar and energy saving measures, including the solar water heating system, is estimated between DKr 50 000 and DKr 70 000. However, because the measures are an integrated part of the house structure, only part of these costs appear as added cost compared to a conventional design. As a consequence, the cost of the houses compare closely with that of a more traditional design. It should be mentioned that the contractor has built 19 more houses of the same design at another building site, again as a cooperative building project.

#### 6.2 COST EFFECTIVENESS

The value of the energy savings for both heating and hot water was approximately 6 600 Dkr. per annum for a type C+ house, giving a simple payback time of 7.5 and 10.5 years. This shows that if energy conservation and passive solar energy features are built into the design from the beginning, total building costs can be similar to the costs for a conventional house, but providing a potential for considerable savings in the long run.

### 7.0 CONCLUSIONS

The passive solar and energy conservation techniques applied in the Smakkebo project are cost-effective, and result in a net heating energy consumptions down to 38%-45% compared to corresponding houses built according to Danish building regulations. The heating load during the first year of operation was approximately 2000 kWh higher than predicted due to significantly worse weather conditions and internal gains somewhat lower than expected. The user acceptance of the houses was very high and an inquiry showed a general satisfaction with the thermal comfort within the houses. The heating load varies considerably among houses of the same type, a consequence of the user effect. The solar hot water systems have proven highly efficient with a system efficiency of 49% covering 60% of the hot water load.





## 1.0 GENERAL

This project is built in a dense urban area of Berlin within a historical block structure. The site faces south to an adjacent street. The building consists of an underground garage with 16 parking places and utility rooms as well as 31 apartments on 7 floors. A central staircase, located on the north side, connects all the apartments and serves as the evacuation route.

### 1.1 PROJECT DESCRIPTION

<b>Architect:</b>	Prof. H. Schreck, G. Hillmann, J. Nagel coop. P. Kempchen, Institut für Bau-, Umwelt- und Solarforschung (IBUS) GmbH Caspar-Theyß-Str. 14A, D-1000 Berlin 33
<b>Energy and Monitoring Consultant:</b>	IBUS GmbH with Prof. Dr. Ing. K. Gertis coop. Dipl.-Ing. H. Erhorn, Dipl.-Ing. R. Stricker Fraunhofer Institut für Bauphysik Stuttgart (FHG) Nobelstraße 12, D-7000 Stuttgart 80
<b>Contractor:</b>	Lützwow Wohnen KG, Haberent Grundstücks GmbH & Co. Cuxhavener Str. 14, D-1000 Berlin 21
<b>Sponsor:</b>	Bundesminister für Forschung und Technologie (BMFT) Postfach 200 706, D-5300 Bonn 2
<b>Scientific Consultant:</b>	Projektleitung Biologie, Ökologie, Energie Jülich (PBE) Postfach 1913, D-5170 Jülich 1

### 1.2 PARTICIPATING ORGANIZATIONS

Status seminar Hasso Schreck, coop. in IEA, Solar heating and cooling program Task VIII.

Publication in "Rationelle und primäre Umweltenergienutzung im Bauwesen".

Status report 1987, Krammer-Verlag, Düsseldorf S. 174-183

"European Conference on Architecture" 1987, W. Palz: Commission of the European Communities, S. 270: "Integrated passive and hybrid solar design in multifamily housing in Berlin".

### 1.3 PROJECT REPORTS

## 2.0 CONTEXT

### 2.1 DESIGN OBJECTIVES

The project is intended to create a prototype of energy efficient design for multifamily housing in a dense urban area with high architectural and living quality.

### 2.2 LOCATION

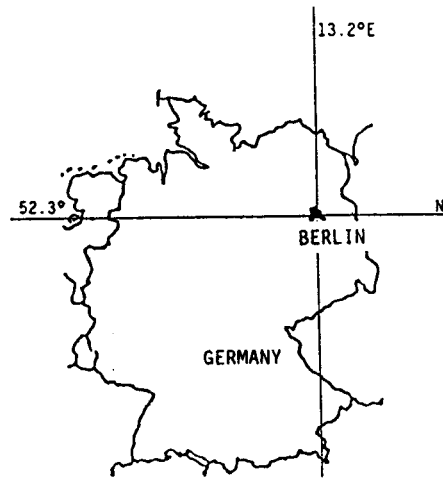

Latitude: 52.3 °N Longitude: 13.2 °E Altitude: 50 Meters Above Sea Level

## 2.3 CLIMATE

In general, the German climate can be characterized as a temperate continental climate which is influenced by the Gulf Stream. During the heating season, moderately cold temperatures are prevailing, with low values of solar irradiation. The fraction of diffuse radiation is relatively high. During summer, the climate is moderately warm and humid. Long term climatic data for Berlin, Germany, are as follows:

Annual Mean Temperature	9.5 °C	Degree Days (18.3 °C Base)	3124
Average Winter Temperature	7.0 °C	Global Irradiation (MJ/m <sup>2</sup> )	3535
Average Summer Temperature	16.7 °C	Diffuse Portion	63 %
Average Annual Relative Humidity	77 %	Sunshine Hours	1706

## 3.0 DESIGN

### 3.1 ARCHITECTURAL DESIGN

#### Vertical Zoning:

The building is oriented on a north/south ground plan with three different apartment types stacked vertically:

- 2-room maisonette apartments, conventionally heated,
- 3- and 4-room split-level apartments with wintergardens, 1 or 2 floors,
- 2- and 3-room apartments with a central atrium.

#### Horizontal Zoning:

Entrance, hallways, utility rooms and bedrooms of all units are oriented north and are reduced to a minimum size. The south facing wintergardens are integrated into the facade and surrounded by the dining room and living rooms. Kitchens and bathrooms are located in the center of the apartments.

The building concept provides two types of wintergardens following the same layout: one and two stories with movable insulation. An apartment with the same floor plan, but with an open balcony instead of a winter-garden, represents a conventional reference unit.

The apartments on the top level have atria instead of wintergardens. All necessary light is provided through the surfaces of the glazed atrium. Entrance area, utility room and bedroom are facing north while living room, dining room, and kitchen are located around the atrium.

#### Vertical Zoning:

The building is facing north/south and is organized into 7 stories:

##### Level 0 - 2

Studio-maisonettes with studios facing to the park, conventionally heated.

##### Level 2 1/2 - 3

Split-level apartments with either one-story wintergardens or loggias.

##### Level 3 1/2 - 4

Split-level apartments with two-story wintergardens facing south, or loggias.

##### Level 5 1/2 - 6

Split-level apartments with loggias.

##### Level 6 1/2 - 7

Split-level atrium apartments.

## 3.2 ENERGY DESIGN

#### Horizontal Zoning:

Passages, entrance halls, utility rooms and bedrooms of all apartments belonging to floor levels 2 - 5 are facing north. Wintergardens with adjacent living rooms and dining rooms are facing south. Kitchens and bathrooms form the heated core of the apartments.

The sections of the building facing north are 1/2 floor lower. This enables a deeper penetration of sunlight in winter and reduces the number of entry corridors.

#### Wintergardens:

There are two types of wintergarden with the same floor area

1. One-story, with interior movable insulation.
2. Two-story, with interior movable insulation.

The wintergardens are separated from the living area by glass panels which can be opened according to thermal conditions (figure 1).

All wintergardens have glazed partitions and depending on the weather, the wintergardens serve as an extension of the living area. Insulated sliding panels, which can be stored behind the exterior facade solar collector, provide temporary insulation and protection from the sun as well. These devices are operated manually.

The heated air from the wintergardens and atria is transferred to the surrounding living area and bedrooms by operable windows, doors, and sliding panels which are operated manually.

The concrete floors of the wintergardens are used for heat storage; the surrounding walls are made of glass panels.

#### **Atria:**

Light and sun reach the upper apartments through an atrium which is entirely constructed of glass (figure 3).

Analogous to the other apartments, bedrooms, entrance areas and utility rooms are facing north. The sleeping rooms get additional light from the south via the atrium. The kitchen, living and dining room which are arranged around the atrium are facing south.

A little gallery in the two story high atrium is accessible by a staircase and leads to the roof garden (emergency egress).

The glazing of the atrium is equipped with a Beadwall® system which has been further developed by Günter Löhnert. The principle of the Beadwall® is a compound window which can be filled with insulating granulate material.

In case of demand the beads are blown into the cavity between the glass panes serving for nocturnal heat insulation in winter or solar shading in Summer.

The window is divided into various sections which can be addressed individually according to users requirements.

#### **Hybrid Solar Heating System:**

Eight apartments are equipped with a hybrid solar heating system, each containing 4 facade air collectors which are located right and left of the wintergardens, 16 ceiling pipes and 8 supporting fans (figure 2).

The air heated in the solar collector is blown into hollow concrete ceiling elements located above the kitchen and bathrooms, and is then returned to the collector.

By this means solar energy is transferred via the medium of air into the storage mass of the ceiling. The collectors are only used during the heating and transition periods when sufficient sun is available.

Automatic interior dampers between the tubes and the collector avoid energy losses of the heated ceiling via the air collector during the night.

The fans are operated by regulators which give optimum control of the air intake depending on the exhaust air temperature escaping from the collector and the air temperature in the tubes of the ceiling.

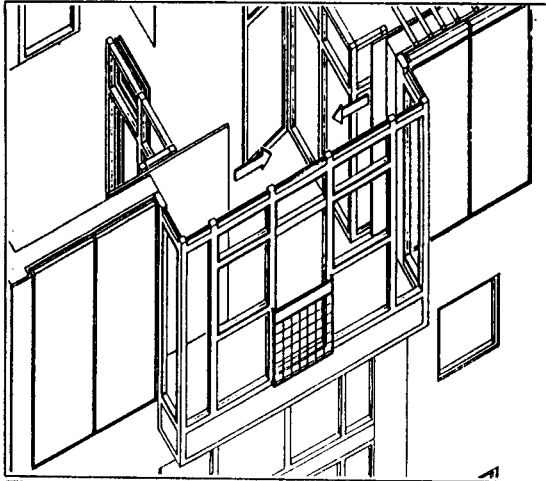

Figure 1: Wintergarden

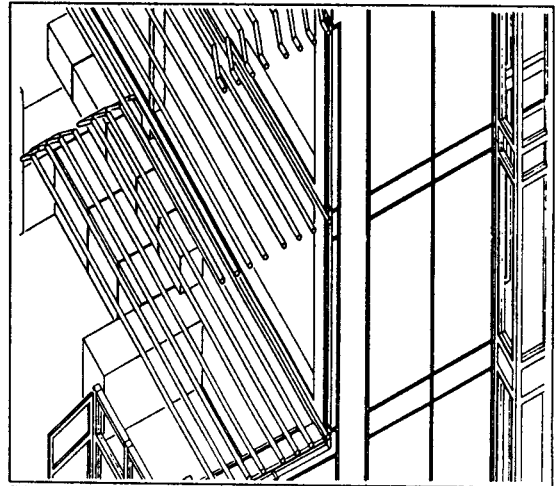

Figure 2: Air Collector, hybrid

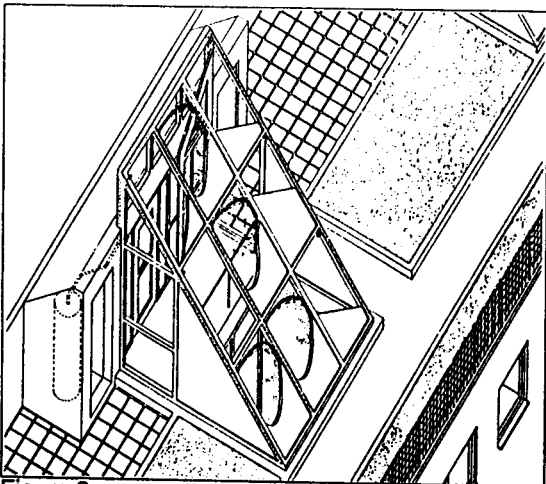

Figure 3: Atrium

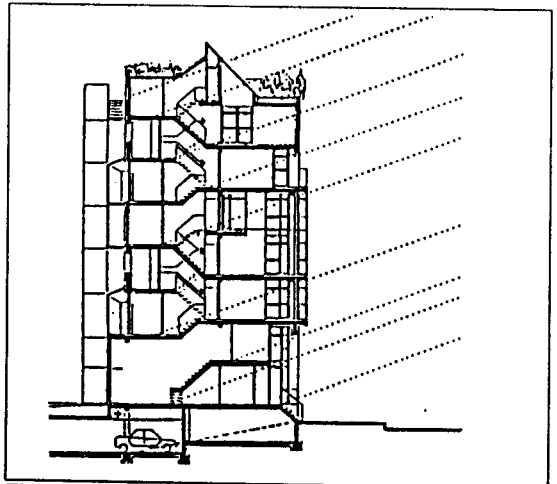

Figure 4: Section A-A

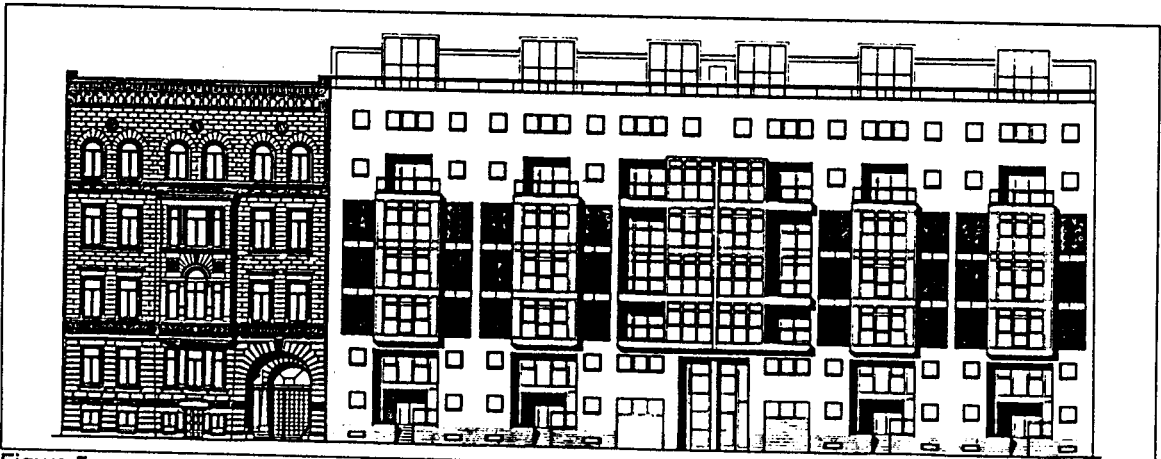

Figure 5: South Elevation

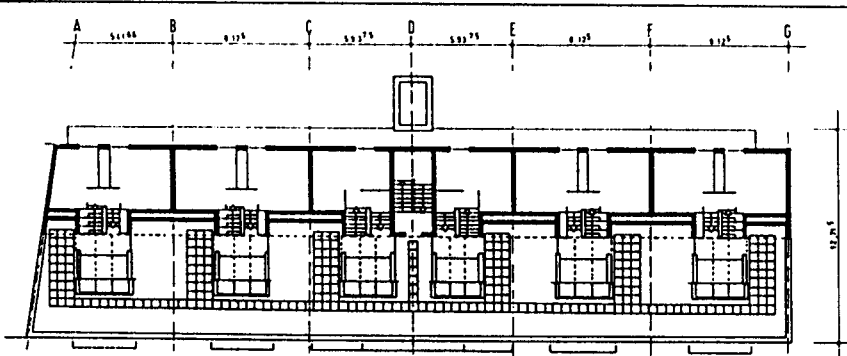

Figure 6:

Floor Level 6 1/2 - 7

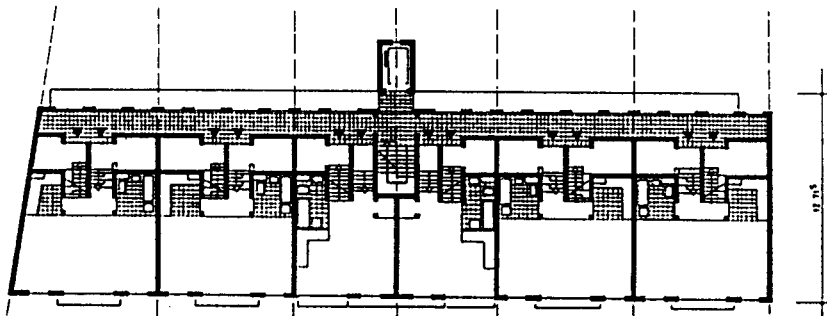

Figure 7:

Floor Level 5 1/2 - 6

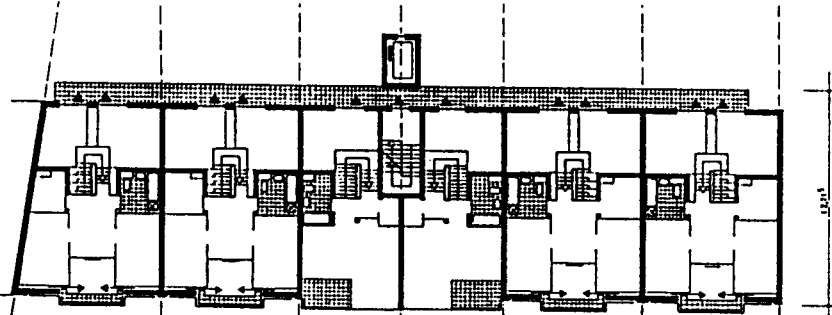

Figure 8:

Floor Level 3 1/2 - 4

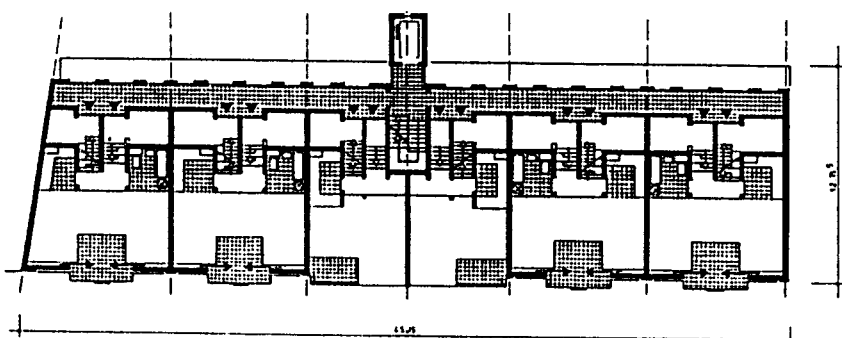

Figure 9:

Floor Level 2 1/2 - 3

Analysis of the IBUS design was performed by Fraunhofer Institut für Bauphysik, using the SERI/RES (SUNCODE) Energy Analysis Program. The calculated performance data will be compared and analysed with the monitoring results of the measurement period.

#### 4.0 ANALYSIS

The monitoring objectives for the "IBUS-HOUSE", Lützowstr. 5 are:

#### 5.0 MONITORING

- to assess the reduction in building heating load and the consumption of non-renewable energy compared to a conventional multifamily house, and
- to assess the year round comfort conditions of the passive solar multifamily house in a dense urban area.

#### 5.1 MONITORING OBJECTIVE

Monitoring data are recorded centrally in each house using two scanners and a portable PC. The computer is programmed in Basic. There are altogether 307 sensor channels which are polled every 10 minutes by the computer; in a next step, recorded data are compiled to hourly mean values or totals, respectively. Data storage (diskettes) are replaced weekly. Subsequently, data are transferred to a central computer for further analysis.

#### 5.2 MONITORING SYSTEM

The monitoring plan includes:

- outdoor air temperature, relative humidity, global horizontal radiation, vertical global radiation;
- indoor air temperatures of all spaces and of the sunspaces;
- surface temperatures and air temperatures inside the hybrid components; surface temperatures and heat flows along the outside surfaces of the hybrid building components;
- electrical power and domestic hot water consumption to quantify internal gains;
- heating energy consumption of the individual units; and
- temporal registration of movement of windows and movable heat insulation devices.

The big difference between measured and predicted values results from user behavior, concerning venting, room zone temperature set point and internal gains.

Infiltration rate :	measured 0.7/h	calculated	0.5/h
Temperature:	measured 22°C	calculated	18.5°C
Internal gains :	measured 400 W	calculated	500 W

#### 5.3 MEASURED AND PREDICTED VALUES

The reference apartment (No.25) calculated with the measured values is predicted to have a specific heat consumption of 81.7 kWh/m<sup>2</sup>.

Preliminary results of energy consumption for space heating during the heating period 1988/1989.

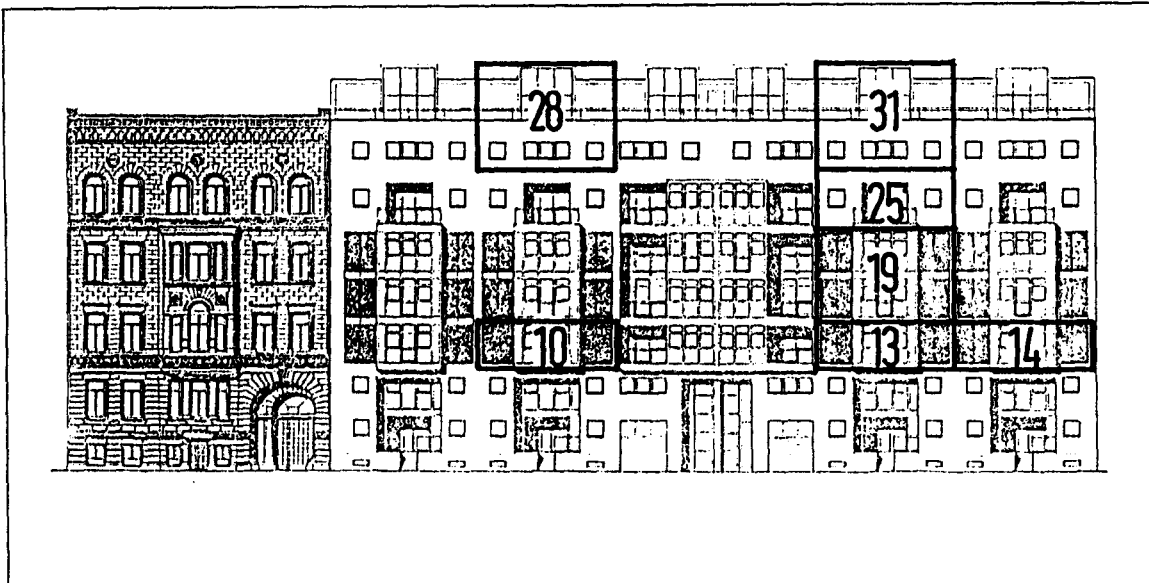

Figure 10:

(Reference Apartment: No. 25)

Unit No.	Heated Area (m <sup>2</sup> )	Total Heat Consump. (kWh)	Specific Heat Consump. (kWh/m <sup>2</sup> )		Average Room Temp. (°C)		Percentage Related to Reference (%)
			pred.	meas.	pred.	meas.	
10	81.5	3386	15.6	41.5	18.5	22.8	50
13	81.5	4183	15.6	51.3	18.5	21.8	60
14	81.5	4554	26.1	55.9	18.5	22.3	67
19	125.1	3943	14.8	31.5	18.5	22.9	38
25	85.5	7092	45.3	82.9	18.5	22.0	100
28	92.2	5955	62.4	64.6	18.5	19.3	78
31	92.2	4704	52.6	51.0	18.5	20.9	61

Figure 11: Comparative Energy Consumption for Space Heating

(Reference Apartment: No. 25)

Unit No.	No. of Rooms	Solar System			Movable Insulation	No. of Exterior Walls
		Direct Gain	Indirect Gain	Hybrid		
10	3		X	X	X	2
13	3		X	X	X	2
14	3		X	X	X	3
19	5		X	X	X	2
25	3	X				2
28	3	X				2
31	3	X			X	2

Figure 12: Passive Solar Features

(Reference Apartment: No. 25)



Extra inner glazing, south facing rooms:	DM	70.000,--
<b>Temporary Insulation</b>		
1. Sliding doors	DM	80.000,--
2. Beadwall® incl. atrium construction	DM	85.000,--
Air collector system and construction (ceiling fan, pipes, electricity)	DM	297.000,--
Row construction (extra costs for the architectural conception)	DM	90.000,--
Wintergarden, additional windows + equipment	DM	85.000,--
<b>TOTAL EXTRA COST:</b>	<b>DM</b>	<b>707.000,--</b>

Wintergarden, double glazing, safety glass, split levels etc. are standardized by the cost limits for social housing in Berlin.

Preliminary monitoring results have shown that the energy saving potential achieved could range above the expected assumptions. The energy performance of the combined wintergarden including movable insulation and hybrid air collector system results in a heating energy reduction of 50 % relative to the reference apartment. The reference apartment consists of a conventional fenestration ratio without any solar features.

Occupants response is very positive:

Aside from decreasing energy costs the users appreciate the increased living quality and the visual comfort provided by the wintergarden as an additional living space.

## 6.0 ECONOMICS

### 6.1 ADDITIONAL CONSTRUCTION COSTS

## 7.0 CONCLUSION



Figure 13: Interior view into the wintergarden of apartment No. 19

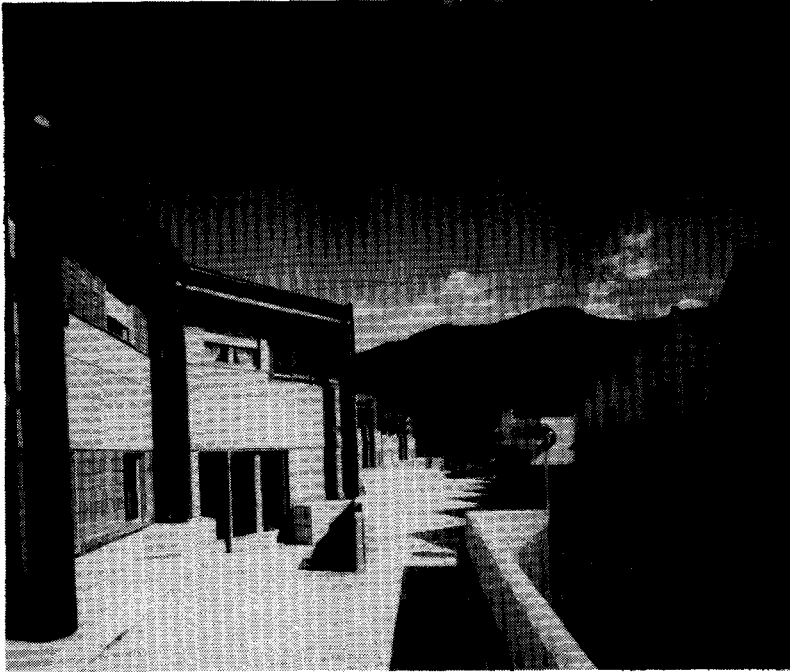

1.0 GENERAL

S. Agata Village is a bioclimatic community located in Lana (Merano). The village consists of 24 dwellings distributed in a two floor Apartment Block (AB) and two Row House Blocks (RH). Ownership is equally shared between the local Public Housing Agency and private owners.

1.1 PROJECT DESCRIPTION

Architects:

Sergio Los  
Dip. Progettazione Architettonica  
Istituto Universitario di Architettura  
S. Croce 197 Venezia

Natasha Pulitzer  
SYNERIA progetti srl  
ctd. Boschetto 9  
36061 Bassano del  
Grappa

1.2 PARTICIPATING ORGANIZATIONS

Luciano Bardelli e Luciano Vattai  
Piazza Domenicani 10  
39100 Bolzano

Energy and Monitoring Consultants:

Ing. Lorenzo Agnoletto  
Istituto di Fisica Tecnica  
Facolta di Ingegneria  
35100 Padova

Ing. Walter Esposti  
UNI, Piazza Diaz  
20100 Milano

Contractor:

Ditta Borededil spa  
39012 Merano

Sponsor (only for design):

Progetto Finalizzato Energetica  
CNR/ENEA  
Via Nizza 128, 00100 Roma

## 1.3 PROJECT REPORTS

**Information about the Lana village project can be found in the following publications:**

S. Los, N. Pulitzer, LA CITTA' DEL SOLE, Proceedings of the International Conference on Energy and Environmental Urban Design, Trieste 1985, sponsored by Regione Autonoma Friuli Venezia Giulia.

S. Los, THE MULTISCALE ARCHITECTURE, in Energy and Urban Built Form, Proceedings of the Workshop, organized by the Martin Centre and the Open University, in Cambridge, U.K., in 1986, published by Butterworth.

S. Los, STANZE SENZA SOFFITTO (rooms without ceiling) in Gran Bazaar, August 1987.

PARAMETRO N. 174, monograph issue on: Sergio Los, Disegni e costruzioni di architettura, Bologna 1990.

S. Los, R. Grossa, N. Pulitzer, IL DISEGNO DI ARCHITETTURA NELLA RAPPRESENTAZIONE INFORMATICA - manuale per i progettisti, Franco Muzzio, Editors, Padova 1990.

S. Los, UN PROGRAMMA REGIONALISTA PER L'ARCHITETTURA in IL REGIONALISMO DELL'ARCHITETTURA, Proceedings of PLEA 1985, Venice, Franco Muzzio, Editor, Padova 1990.

BOOKLET NO. 7, THE DESIGN LANGUAGE, IEA TASK VIII.

## 2.0 CONTEXT

## 2.1 DESIGN OBJECTIVES

**The overall goal of the project was the integration of low-rise, high density housing with energy saving strategies, while improving the environmental quality associated with the history and the geography of the site. Lana Village, unlike other single family houses in the surrounding suburbs, proposes the reevaluation of public spaces, which in the past characterized most of the regional villages, and which appropriately interprets their architectural language.**

**The primary design objectives of the project are to:**

- **reduce energy consumption through optimization of building and urban space factors, geometry and construction technology, in order to control the indoor and outdoor microclimates;**
- **improve comfort of an exterior urban space by increasing the surrounding surface temperatures;**
- **reduce maintenance costs by the use of proven technologies;**
- **pursue an architectural design language that expresses the local cultural identity.**



Latitude: 46° N Longitude: 11° Altitude: 325 Meters above Sea Level

**2.2 LOCATION**

Lana Village is located in a rural alpine valley of northern Italy. In the winter season the climate is typical of continental mountain regions, with low temperatures but high radiation levels. The summers are hot and sultry with a high day-night temperature swing. Long term climatic data for Bolzano (the reference station) are shown below:

**2.3 CLIMATE**

Average Annual Temperature..... 11. 4°C Annual Degree Days: (base 18/22) 2580 hrs

Average Winter Temperature .....5.6°C Global Irradiation Oct - Apr  
1786. 3 Wm,  
(496.2 kWh m<sup>2</sup>)

Average Summer Temperature..... 22°C Annual 4773.6 Wm (1326 kWh m<sup>2</sup>)

Average Annual Relative Humidity:.....60% Sunshine Hours Oct - Apr 969 hrs; Annual: 2032 hrs

Wind: 1 m/s in winter, with prevalent direction from the north; between 1 and 1.5 m/s in other months with prevalent direction from the south in summer

Microclimate of the site (before intervention): Continental climate, with very cold winters, min. temp. -15°C; very hot summers, max temp +40°C sultry weather because of the lack of natural ventilation

**3.0 DESIGN**

The compactness of the whole settlement system, because of the appropriate selection of building types, achieves both a strong characterization of the site (apple trees and countryside) and a great flexibility (the dynamic envelope) which copes with changing climatic conditions. The system behaves like a shell

**3.1 ARCHITECTURAL DESIGN**

that avoids the undesired climatic factors (such as the cold winter wind), opening itself out in the summertime to collect the south breezes while a large broadleaf tree, growing from the lower level under the piazza, provides the central part of the public space with natural shade.

Vegetable gardens are located at the rear of each building, while the main entrances face the central piazza. An underground space, accessible from the street, includes car parking, cellars, and heating equipment.

### 3.2 ENERGY DESIGN

Since the first stages of the design process, a multi-scaled approach has been pursued as one of the most interesting, innovative, and effective energy saving strategies.

Following the methodology described in Booklet 7, we first defined a *types repertoire* organized into three design levels: the *Room Level (L1)*, the *Building Level (L2)*, and the *Street Level (L3)*. This repertoire includes a set of issues that couple the shapes and the related performances as satisfactory solutions, according to regional climate conditions and cultural characteristics. A number of building types were then selected from the repertoire and modified in order to fit the specific site and user requirements.

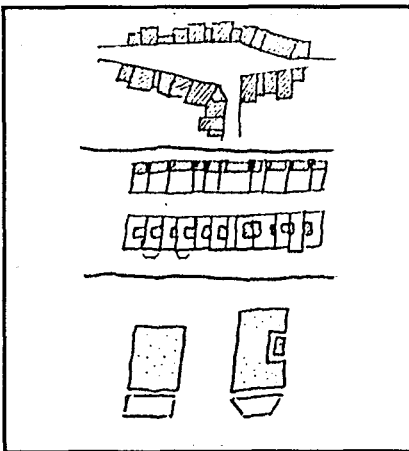

*The three design levels*

### STREET LEVEL DESIGN

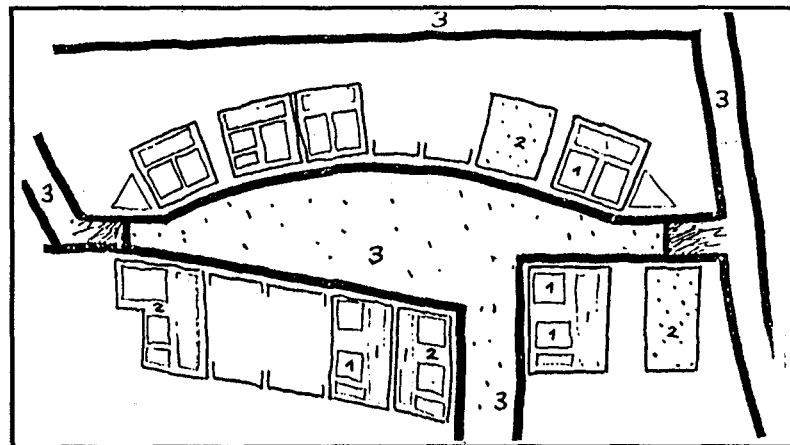

*The multi-scale system*

The final project results are as follows:

- at the *Street Level (L3)*, the microclimate conditions have been modified by designing the piazza as a bioclimatic open air room, south oriented to follow an E-W main axis, and split to force cross ventilation in summer. The piazza walls appear to be asymmetric, as the size and shape of windows are determined by both the energy requirements of aperture ratio in respect to orientation, and by the social role of the facades, which may face the public central space or the private gardens.

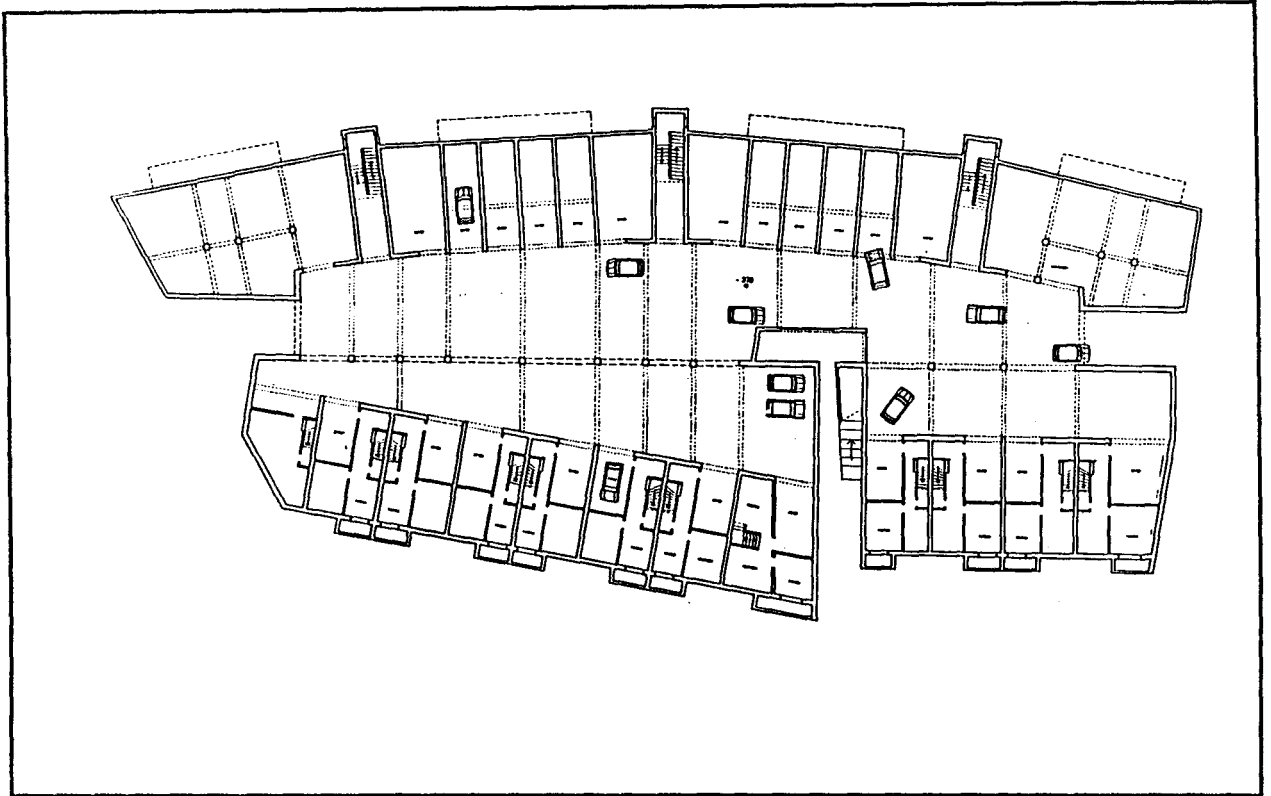

*Plan Layout - Garage Level*

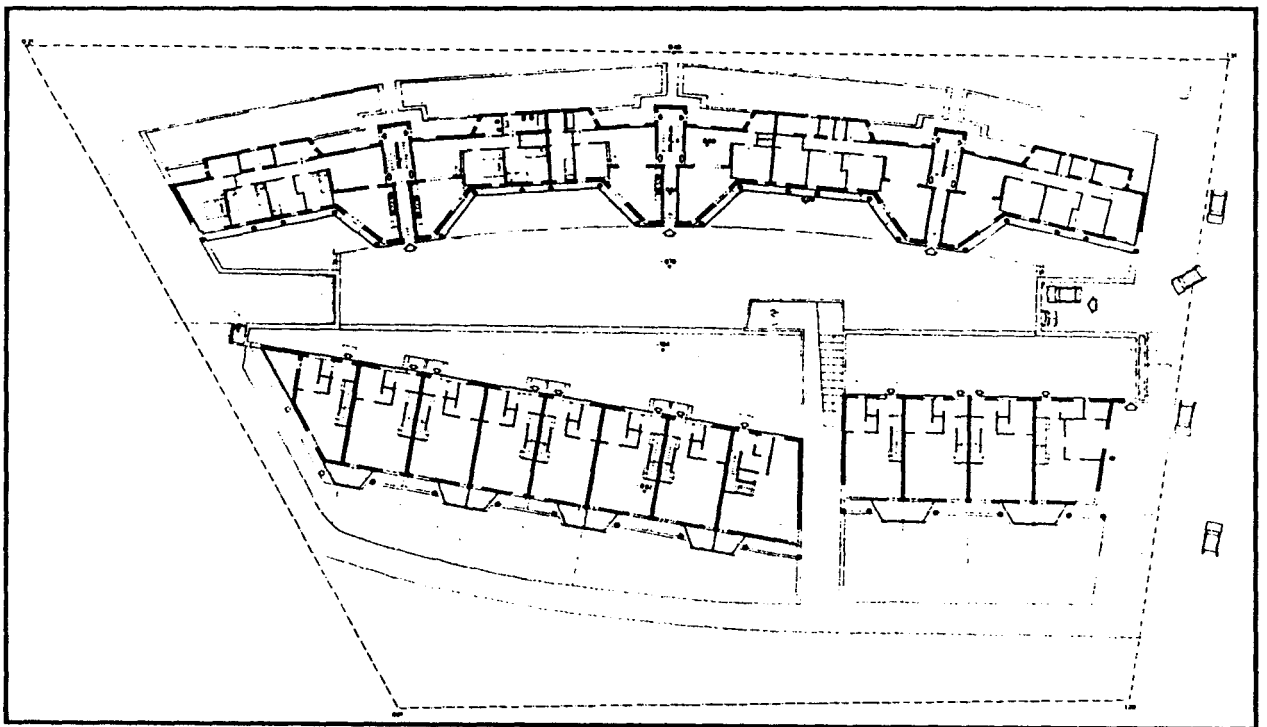

*Plan Layout - Piazza Level*

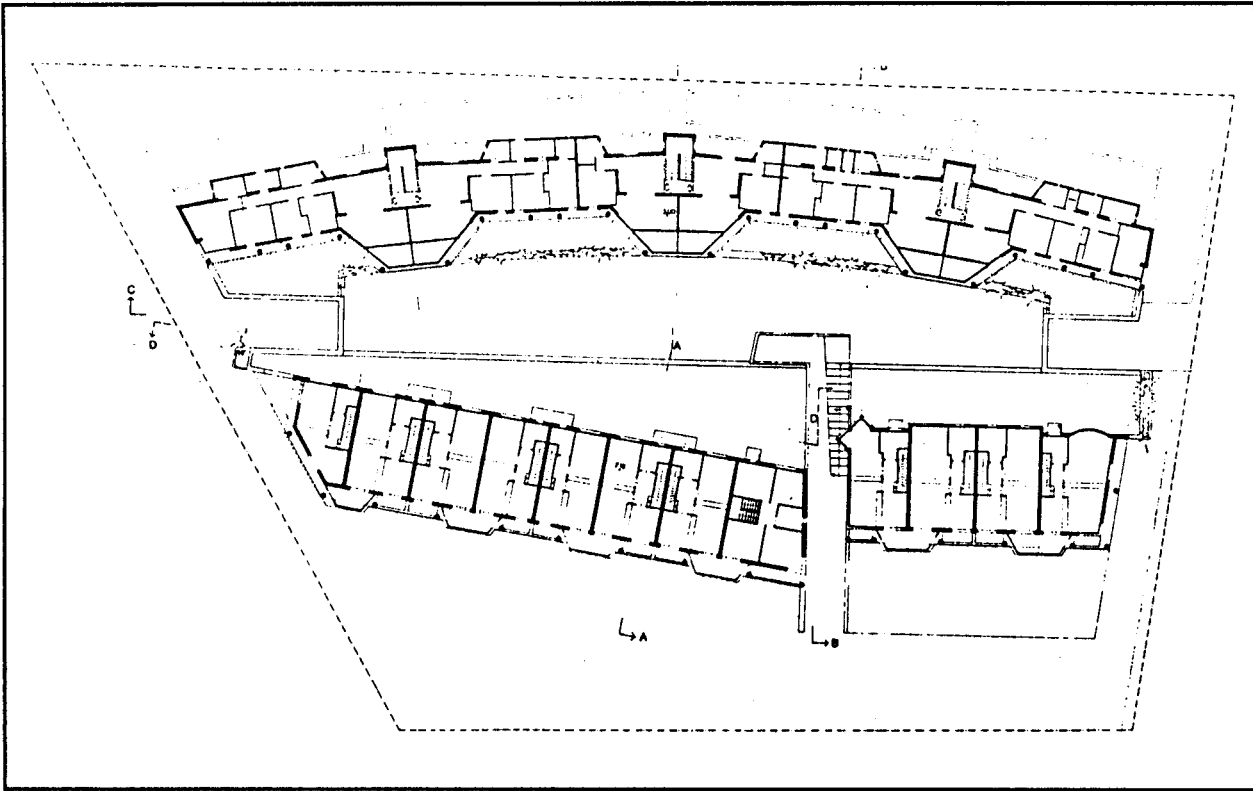

*Plan Layout - First Floor*

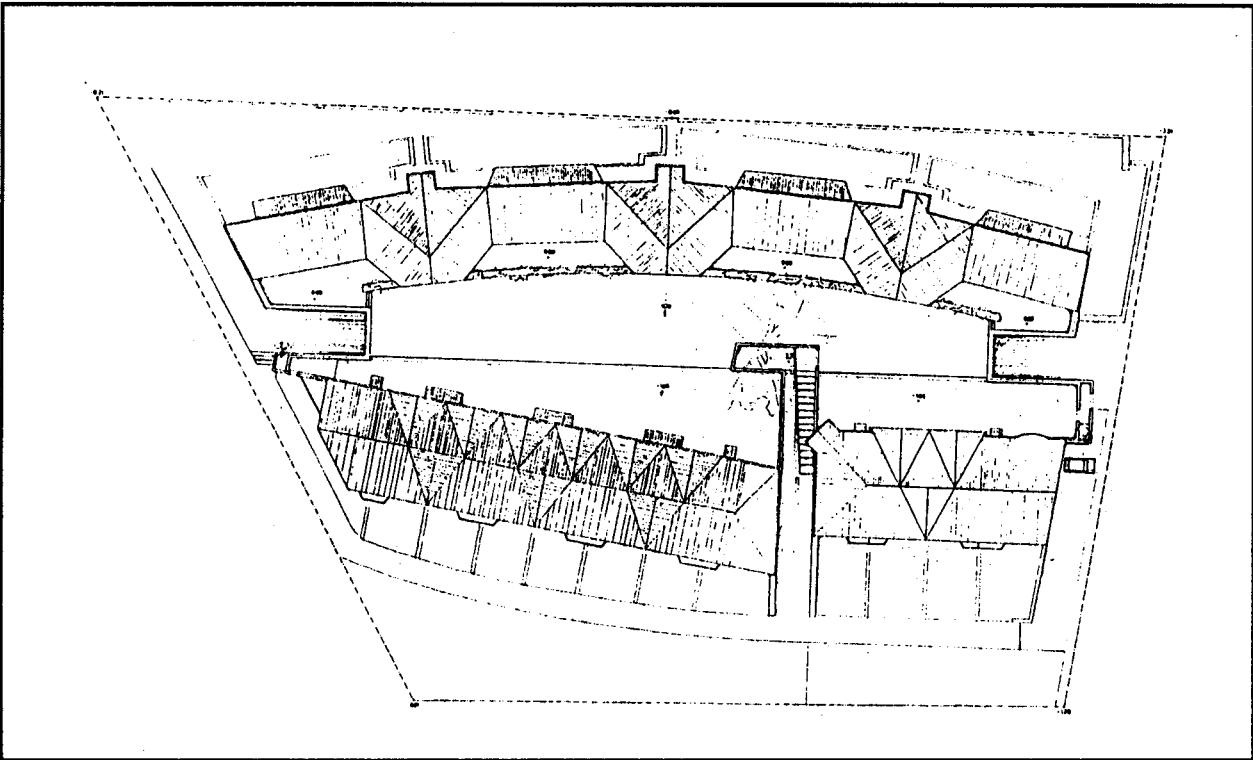

*Plan Layout - Roof*



- at the *Building Level (B2)*, two different building types were selected: Apartment Block (AB) on the north side of the piazza, and several deep, two story, Row Houses (RH) with internal staircases on the south side of the piazza.

## BUILDING LEVEL DESIGN

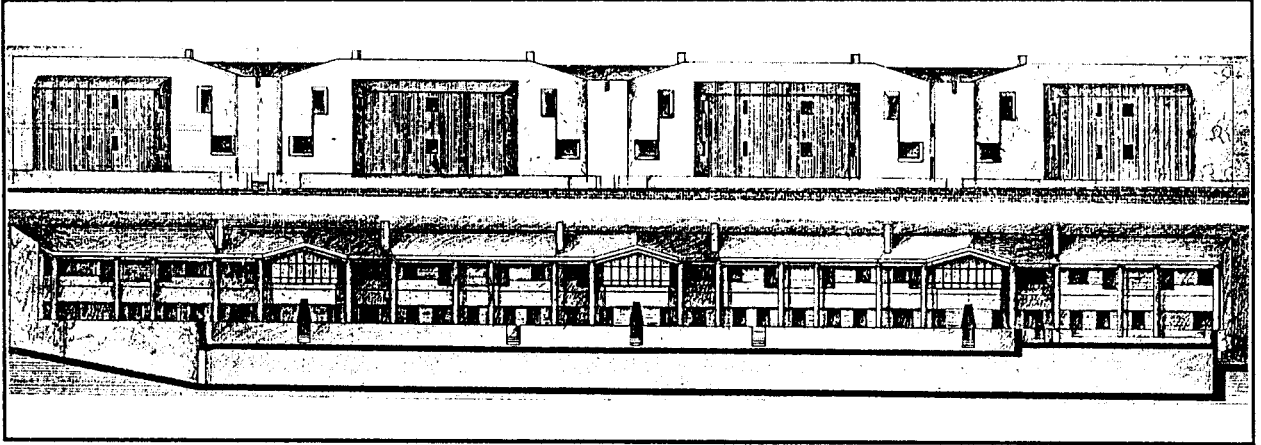

*Unilateral apartment block north and south elevations*

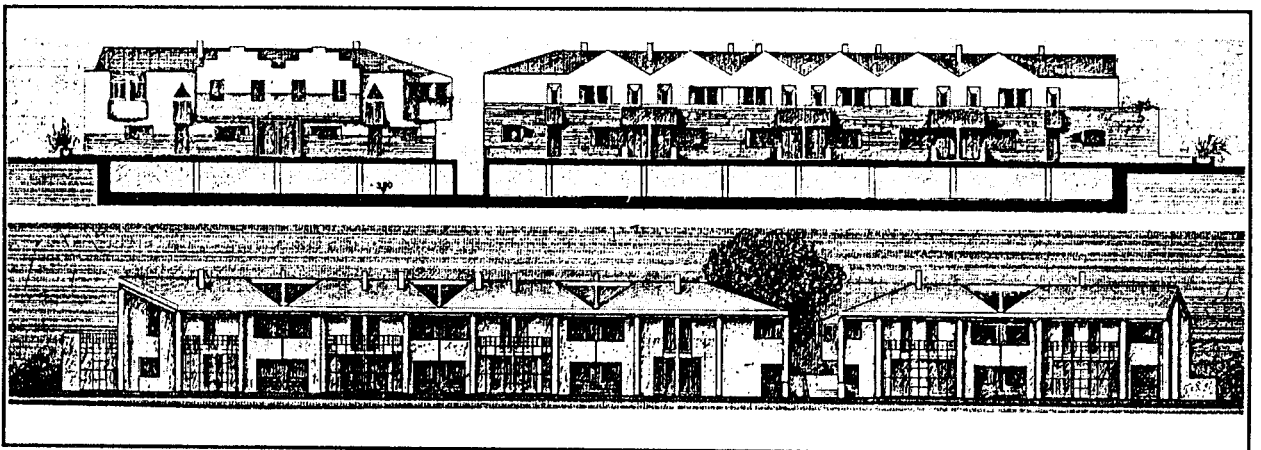

*Row Houses north and south elevations*

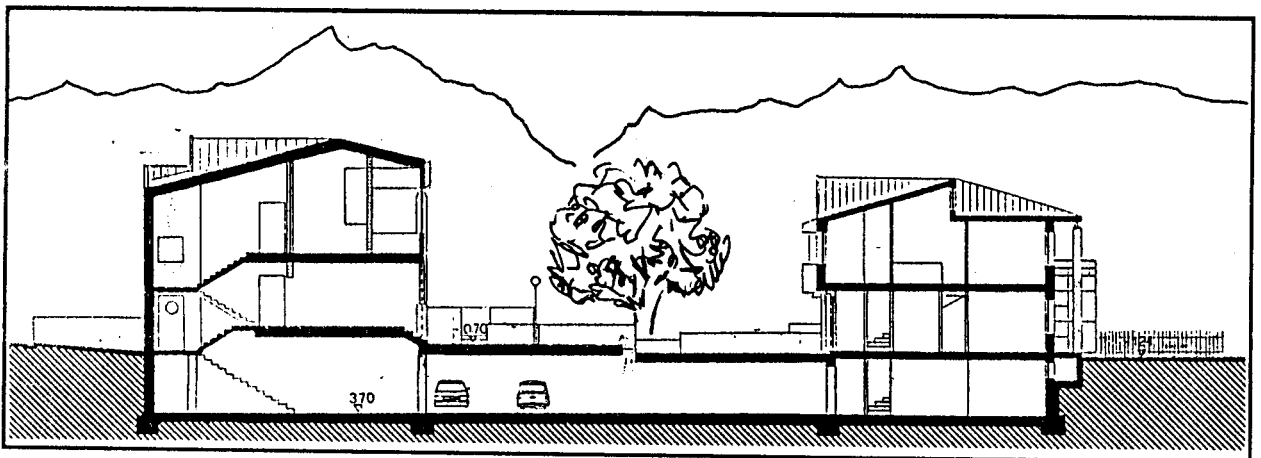

*Cross section through the settlement*

**ROOM LEVEL DESIGN**

- at the *Room Level (L1)*, solar energy is collected through south facing rooms with direct and isolated gain windows, sunspaces, and glazed verandas; through north facing rooms with direct gain roof skylights; and sheltered from north winds through the location of service rooms, acting as buffers, on the rear of northern walls of the Apartment Block (AB).

**4.0 ANALYSIS**

The energy behavior of the Lana Community Building has been tested since the first stage of the design process using a special Nomograph. This simplified graphic method, developed for other Italian climatic areas within the CNR/PFE research work, allows rapid calculation of seasonal energy demand with a limited amount of data, such as: the building type and orientation, the surface-volume ratio, the average U-value of the envelope, the kind of glazing, the weight of the building fabric, and so on.

**4.1 BUILDING OPTIMIZATION**

Detail energy analyses were later performed using MORE, a dynamic computer simulation program. The MORE results were within 10% of previous nomograph results. Finally, the energy performance of the design was analyzed using Method 5000.

**4.2 MICROCLIMATIC CONTROL**

The climate behavior of the central outdoor space (piazza) has been analyzed with a computer model which, according to its specific geometric characteristics and climatic parameters, simulates the temperature profiles outside. The input data are: the urban model orientation; the time pattern of the cast shadows; the total and diffuse solar radiation incident on the vertical and horizontal surfaces; the shape factors of the space, i.e., the relationship between the heights of buildings and their distance; the material used; the surface finishes of walls and pavements; and the speed and direction of winds. The simulation output is a set of temperature values arranged in a three-dimensional matrix.

The relevant issue pursued within the Italian Research Program consists of defining ways to test the outdoor comfort conditions and, more generally, the differences between the microclimate within the square and that around the village.

**5.0 MONITORING**

The monitoring objectives for the Lana Village are evaluations of:

- the outdoor environmental conditions within the piazza, and
- the indoor climate within an apartment and an attached solar space.

**5.1 MONITORING OBJECTIVES**

The fluid dynamical thermal field of the air which occurs within an outdoor space surrounded by buildings generally differs from that of open spaces. The solar radiation collected by external surfaces and the air flow induced by processes related to the different air pressures create very different environmental microconditions, variable point by point, which influence the thermal characteristic of urban spaces.

**5.2 MONITORING SYSTEM**

---

The data acquisition equipment utilized consists of a computerized data logger and sensors. The data logger is a MICROS UCS System with a CBM recorder with a static memory. The CBM recorder is connected to a PC for controlling data collection and to the sensors through an interface device.

The measurements made included:

- Meteorological data: outdoor temperature, wind speed, wind direction, and solar radiation;
- Piazza microclimate data: outdoor temperature, air speed (at three directions), surface temperature, and ambient illumination level;
- Indoor climate data: indoor air temperature (at different heights), indoor radiative temperature, air speed (at three directions), and illumination levels.

The monitoring period was too short to define the average heating consumption of the buildings. Nevertheless, the consumption registered by the owner over a two year period showed a 35 percent reduction in comparison with other apartment blocks built according to the national energy saving standards.

### 5.3 PERFORMANCE RESULTS

Monitoring the local climate within the central public space against site microclimate (after intervention) in the winter season, a rise in temperature of about 2-3° C was measured, probably due to the reduction of the cold northern wind together with the solar contribution. In the summer season, the anemometers show the presence of air flow induced by the specific shape of the piazza which allows for an open space ventilation that should also increase when the central tree is bigger.

Before the construction of this settlement system, the occupants were rather skeptical, mainly because of the building type choice. Single family houses on private lots were considered to be more innovative and desirable than apartment blocks and row houses. On the other hand, the idea of a demonstration community had some economic advantages that made this experience not only possible, but very exciting. Today the occupants seem to be very satisfied with the high standard of comfort conditions achieved, the energy savings, and the interesting living spaces. In the milder seasons, they also enjoy the verandas, the sunspaces, and the central piazza, where children play and adults converse.

### 5.4 OCCUPANTS EVALUATION

**6.0 ECONOMICS**

Contracts for the buildings were signed in 1986, at an average purchase price of:

1,050,000 Lit/m<sup>2</sup> for public buildings,  
1,150,000 Lit/m<sup>2</sup> for private buildings.

The construction cost was 930,000 Lit/m<sup>2</sup>. The final cost including underground spaces, solar spaces, and piazza was Lit 3,000,000,000.

**6.1 ADDITIONAL COSTS**

The additional cost for high efficiency heating systems, solar spaces and verandas, and surface finish of the piazza, was Lit 150,000,000. However, the builder received a local government contribution of Lit 170,000,000 from a local energy saving program.

**7.0 CONCLUSIONS**

Our experience leads us to recognize that the use of solar energy is more productive when it is based on the synergetic action of different contributions rather than concentrating on the efficiency improvement of a single device (solar collectors, panels, walls, etc.). If taken separately, these components may appear quite irrelevant, but in a cooperative situation their individual contribution is multiplied.

This synergetic action improves the cooperation among different components at the same scale (for example, at the building scale) and at different scales (such as between the building and the street).

Following this approach, the environmental control of a space is based on the control of those spaces which include it or are included by it. Instead of pursuing a space climatization by insulating it from the surrounding environment (or from the spaces it surrounds), one should produce conditions which reduce the differences between one space and another through a fading effect (as a kind of nebula, in which density corresponds to temperature).

Multi-scale architecture represents a way of practicing such a synergetic approach.

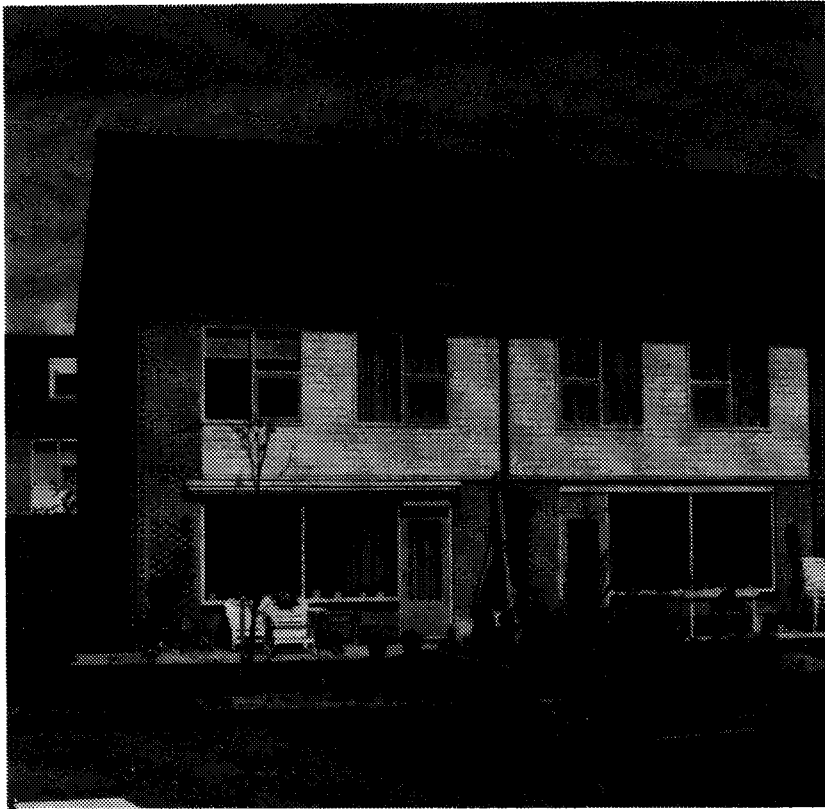

## 1.0 GENERAL

The Hoek van Holland project consists of 60 small row houses, which are provided with passive measures to utilize solar energy. The houses are oriented North-South, are well insulated and draught-proof. In seven of the houses an active/hybrid solar energy system has been installed for space heating and domestic water heating.

### 1.1 PROJECT DESCRIPTION

A new type of solar collector, the so-called double airflow collector, supplies heat which is stored in the hollow concrete floor of the first floor and in the hot water boiler.

**Principal** : N.V. Bouwfonds Nederlandse Gemeenten, P.O. Box 15  
3870 DA Hoevelaken

**Architect** : Architecten Gemeenschap Van den Broek en Bakema,  
Project Architect: S. Karsten, Posthoornstraat 12b,  
3011 WE Rotterdam

**Contractor** : Bouwbedrijf Fraanje B.V., P.O. Box 4008,  
2980 GA Ridderkerk.

**Research** : Bouwcentrum Advies, P.O. Box 299, 3000 AG Rotterdam.

**Financing** : NOVEM, P.O. Box 8242, 3503 RE Utrecht.

### 1.2 PARTICIPATING ORGANIZATIONS

### 1.3 PROJECT REPORTS

1. Rapport betreffende opbrengsten en kosten van een tweede generatie zonne-energiesystemen op basis van luchtcollectoren, Lammers, ir. J.M., Bouwcentrum B.V., rapportnummer 9700, Rotterdam, juni 1984.
2. Meting van een hybrids zonnestelsel te Hoek van Holland, Straatman, ing. J.T.H., Bouwcentrum B.V., rapportnummer 14505, Rotterdam, maart 1989.
3. Meting luchtdoorlatendheid, project 36 koopwoningen aan de Mercatorweg - C. Weenigstraat te Hoek van Holland, Straatman, ing. J.T.H. en Oliërhoek, C.H.J.J., Bouwcentrum B.V., rapportnummer 11296, Rotterdam, mei 1986.

## 2.0 CONTEXT

### 2.1 DESIGN OBJECTIVES

The goals of this demonstration project are to promote the development and introduction of new energy saving options in social housing and to be a complementary addition to the mid- and long-term national energy saving policy.

### 2.2 LOCATION



Latitude 52°0' N      Longitude 5°11' E      Altitude 0 m (sea level)

Hoek van Holland lies on the sea. The maritime climate is characterized by mild winters and cool summers; the prevailing wind is southwest and the wind velocity is 5 m/s.

### 2.3 CLIMATE

The average climatological data are as follows:

Average annual temperature: .....	9.2 °C
Average winter temperature: .....	6.9 °C September-May
Average summer temperature: .....	16.1 °C June-August
Average Annual Relative Humidity: .....	83 %
Degree Days (Base 18 °C) <sup>1)</sup> .....	3000 September-May
Global Irradiation: .....	3530 MJ/m <sup>2</sup>
Annual Sunshine Hour: .....	1505 h

<sup>1)</sup> Measured at outdoor temperatures below 15.5 °C.

## 3. DESIGN

The low cost small family houses have two floors and an attic. Six houses are oriented East-West; 54 houses are oriented North-South including seven houses in which active solar collectors have been installed (figure 1).

### 3.1 ARCHITECTURAL DESIGN

The living area(floor) to be heated is 105 m<sup>2</sup> and the volume of the house is 360 m<sup>3</sup>. The living room faces south (figure 2).

To increase the thermal mass of the house, the shell is built of massive materials; the walls are of sand-lime bricks and the floors are of prefabricated concrete. The walls between houses are cavity-walls; they are insulated in order to minimise the heat and noise transmission between the houses. A hollow concrete slab has been chosen for the floor of the first floor to facilitate the transmission of the hot air from the collector and for heat storage. The upper surface of this floor is insulated.

The north facade consists completely of brickwork; the first floors on the south have wooden fronts. The architecture of the houses does not differ greatly from that found in the immediate vicinity (figure 3).

The following passive measures have been provided in all 60 houses:

- added wall and ceiling insulation (figure 4);
- the lay out of the houses is adapted to the orientation;
- favourable sun protective angle of the south facade.

### 3.2 ENERGY DESIGN

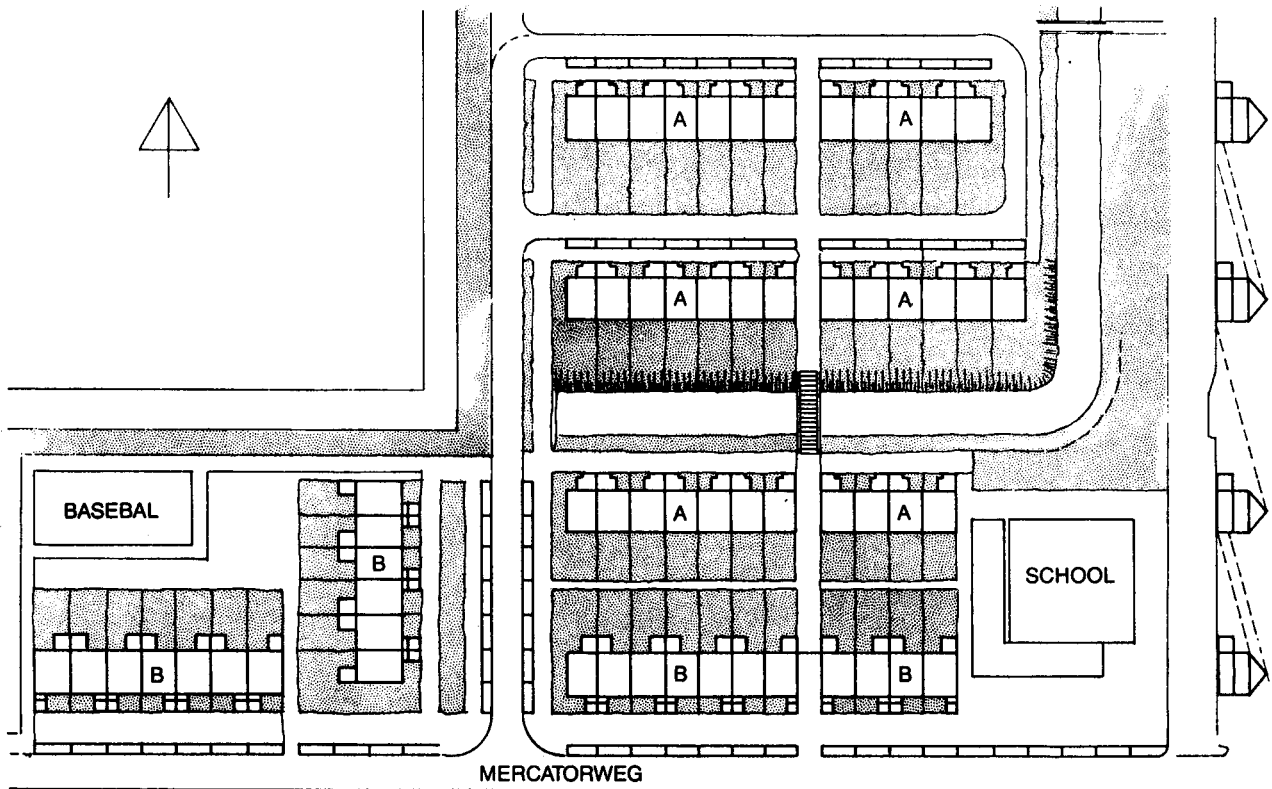

Figure 1: Site Plan

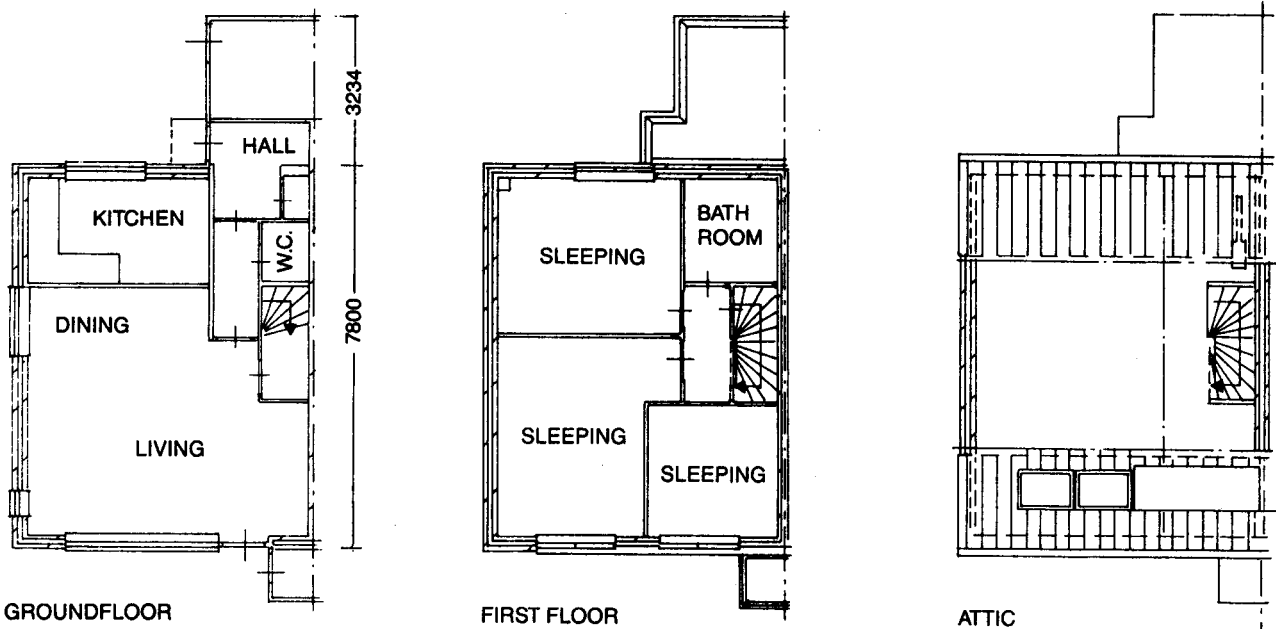

Figure 2: Floor Plans





Figure 3: facades and sections

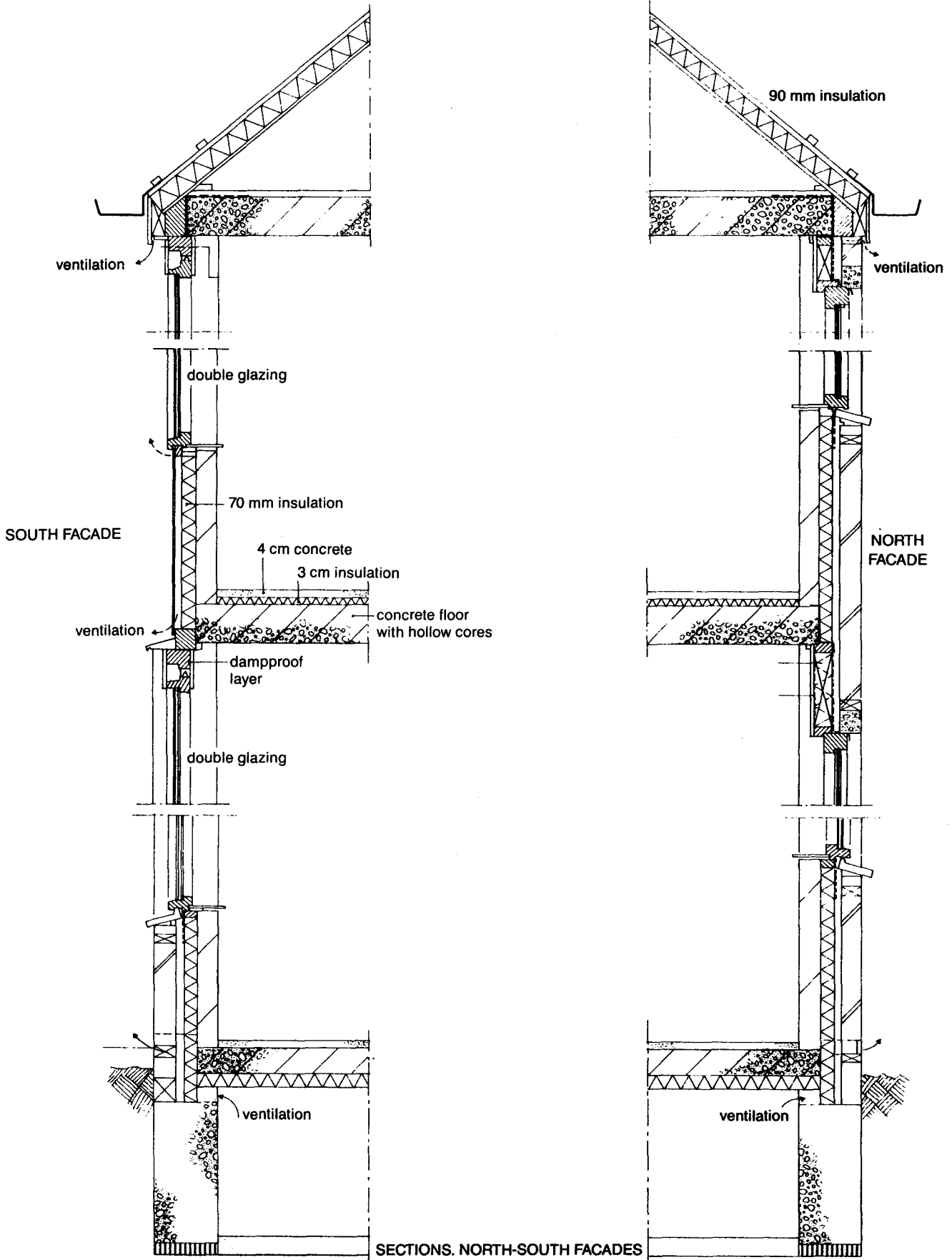

Figure 4: Sections North-South facades

The insulation U-values of the shell are as follows:

floor	U = 0.49 W/m <sup>2</sup> K;
roof	U = 0.42 W/m <sup>2</sup> K;
closed part of front	U = 0.44 W/m <sup>2</sup> K;
glazing living room/kitchen	U = 1.75 W/m <sup>2</sup> K;
other glazing	U = 3.20 W/m <sup>2</sup> K.

The layout is such that the living room and the children's bedrooms are oriented to the South, while the kitchen, the hall, the parents' bedroom and the bathroom face north.

The active/hybrid system has been installed in 7 of the 60 houses and consists of:

- three double flow air collectors with a total surface area of 8.1 m<sup>2</sup>.  
The collectors are fitted with a spectral selective absorber and a single glass cover.
  - a hollow concrete floor (slab) with a total heated surface of 20.6 m<sup>2</sup> and a heat capacity of 5.4 MJ/K (1.5 kWh/K). This constitutes part of the ceiling of the living room and is insulated on the bedroom side with a layer of polystyrene foam 30 mm thick;
- a ventilating fan and control equipment;
- a hot water storage tank for domestic hot water production with a capacity of 120 litres.

The air collectors have two separate air-duct systems:

- one air-duct is connected to the hollow floor (concrete slab) of the first floor for the purpose of space heating;
- the other air-duct is connected to the solar boiler for domestic water heating.

In the closed space heating circuit, the heated air from the collector is transported with the aid of a fan to the hollow concrete floor slab of the first floor and is discharged into the floor (figures 5 and 6). By radiation and convection the floor then gives off the absorbed heat to the house. Its control, as in the case of the boiler circuit, takes place with the aid of a temperature difference regulator. It switches on the fan, as soon as the air in the collector is hotter than the floor.

#### HYBRID SOLAR SPACE HEATING

To prevent overheating of the house by the solar energy system, a thermostat which blocks the fan when a certain room temperature is exceeded, is fitted in the control circuit. Because the upper side of the floor of the second floor is insulated (30 mm polystyrene foam), most of the heat absorbed on the floor is given off on the ceiling side of the floor. In the case of a negative temperature difference or when a certain maximum floor temperature is exceeded, the fan is switched off. The house has an auxiliary central heating system with radiators.

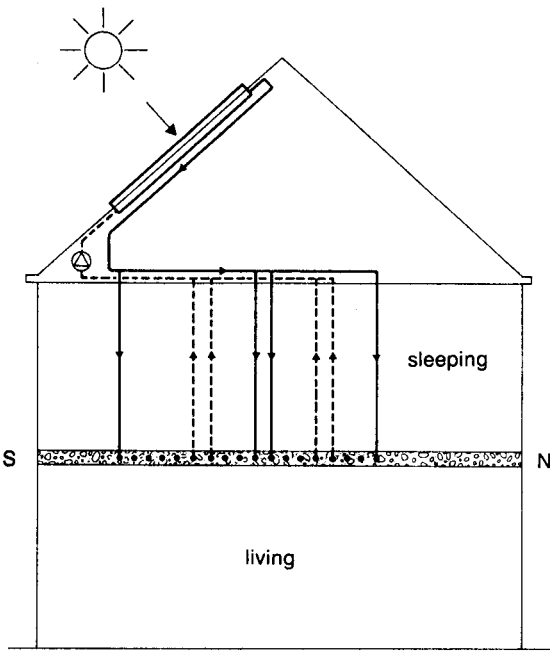

Figure 5: Hybrid solar system

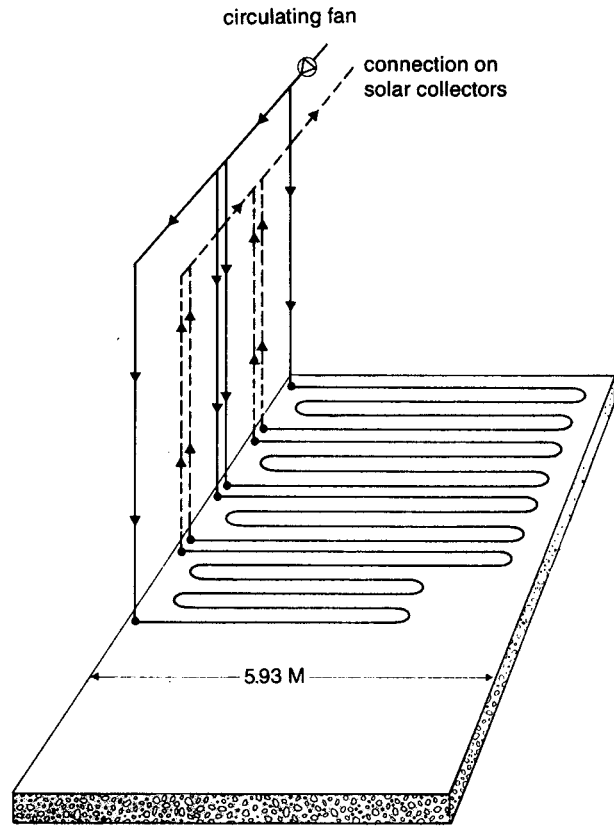

Figure 6: Storage in second floor/ceiling

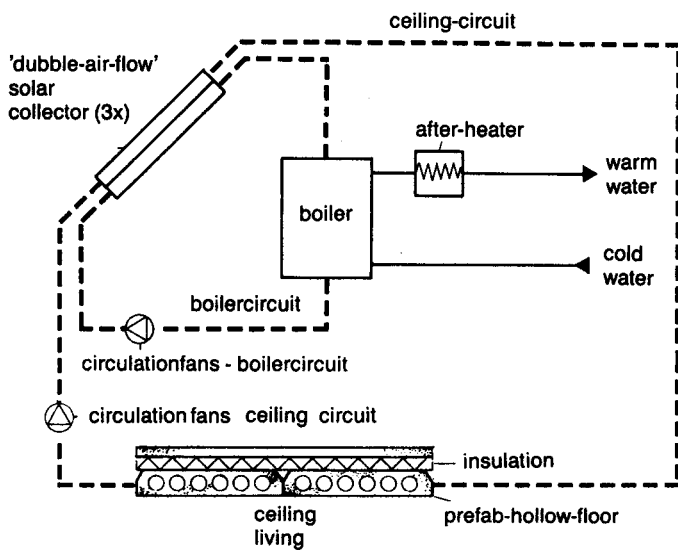

Figure 7: Hybrid solar system and solar boiler

In the closed solar boiler circuit, the heated air from the collectors is transported with the aid of a fan to the boiler where the heat is discharged into the water (figure 7). Its control takes place with the aid of a temperature difference regulation which switches on the fan as soon as the air in the collector is hotter than the water in the boiler. The fan is switched off when the boiler temperature is higher than or equal to the temperature of the collector. A "maximum thermostat" in the boiler stops the fan when the maximum allowable temperature of the water is exceeded.

SOLAR DOMESTIC  
HOT WATER HEATING

Observations with respect to the regulating equipment:

- The solar system for space heating and for domestic hot water heating are separately controlled.
- During the summer months, the circuit for the space heating system is switched off.
- Both circuits (the floor construction and the domestic hot water boiler) are protected against overheating.
- The auxiliary space heating system is independently controlled by a room thermostat.

Energy Balance of Solar House:  
(m<sup>3</sup> natural gas per month)

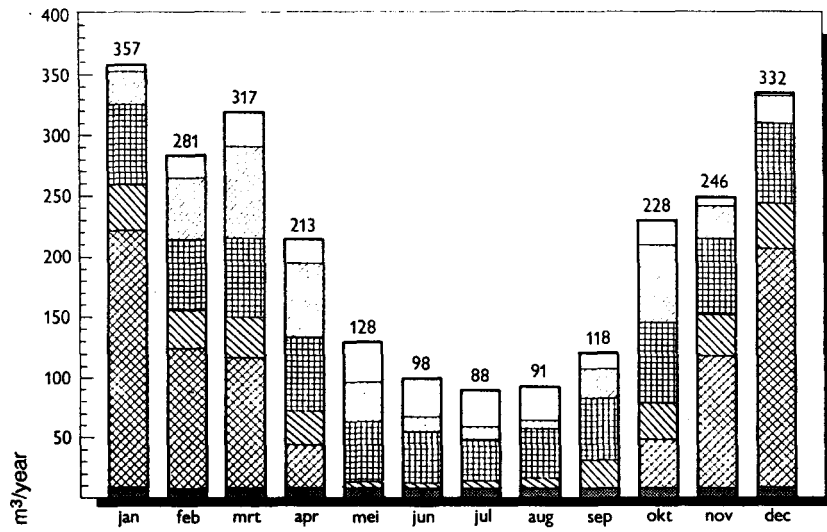

Energy Balance of Reference House:  
(m<sup>3</sup> natural gas per month)

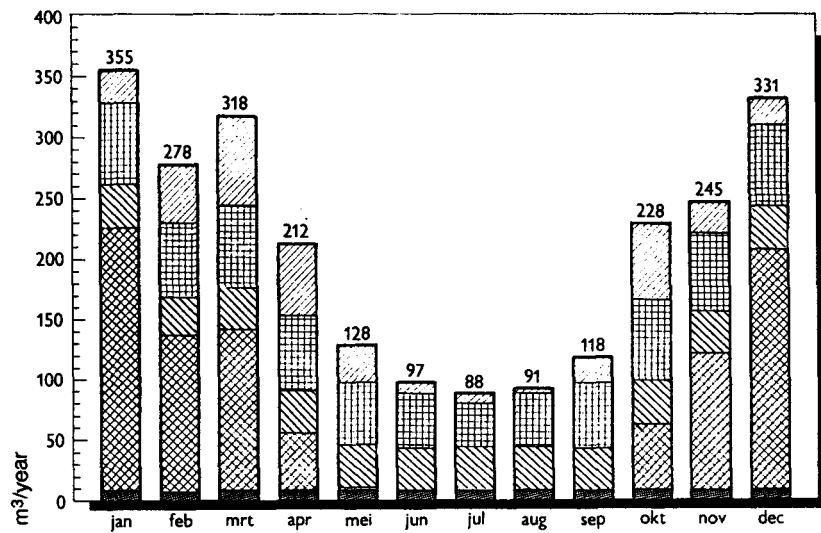







-  cooking
-  auxiliary heating
-  internal gain
-  hot water supply
-  passive solar gain
-  active solar gain

Figure 8: Energy balance Solar House and Reference House

The Solar House has been analyzed thoroughly, using the SUNCODE computer program. A second SUNCODE model was developed for a reference house, whose design is based on homes of Dutch construction, as a basis for comparing the energy savings achieved in the solar house. Climate data for De Bilt was used in the analysis.

#### 4.0 ANALYSIS

##### SIMULATED ENERGY BALANCE OF THE SOLAR DWELLINGS

In the table below the energy balance of the dwellings is given (table 1, figure 8).

The total energy-consumption for space heating, hot water production and cooking, under the simulated circumstances, is 8,250 kWh (1,185 m<sup>3</sup>) per annum for the solar houses and 9,840 kWh (1,410 m<sup>3</sup>) per annum for the reference houses. The use of natural gas proves to be 225 m<sup>3</sup> less for the solar houses under average circumstances than for the reference houses (table 2).

Table 1: Energy balance of the dwellings on an annual basis in kWh (climatic year 1964, location De Bilt)

	solar house		reference house	
	space heating	hot water	space heating	hot water
total heat demand	12740	2930	12740	2930
- internal heat production	3805		3915	
- supplement passive solar system	2690		2580	
+ -----			+ -----	
- total heat gain	6495		6495	
	-----		-----	
profit solar system	560	1030	-	-
	-----	-----	-----	-----
reheat	5685	1900	6245	2930

Table 2: Energy consumption of the dwellings, in kWh per annum (climatic year 1964, location De Bilt)

	gross energy consumption	reheat	
		solar house	reference house
space heating	12740	5685	6245
hot-water production	2930	1900	2930
cooking	665	665	665
+ -----		+ -----	+ -----
total in kWh	16335	8250	9840
total in m <sup>3</sup> natural gas	-	1185	1410

## 5.0 MONITORING

### 5.1 MONITORING OBJECTIVE

By carrying out measurements, the contribution of the hybrid space heating system to the heat demand of the house is determined. The energy contribution of the solar boiler to the domestic hot water is also determined.

### 5.2 MONITORING SYSTEM

In one of the seven hybrid solar houses extensive measurements have been carried out. In the six adjacent solar houses, limited measurements have been made. To determine the energy savings of the solar houses, limited measurements were taken in seven identical conventional houses.

The consumption test consists of the following activities:

- checking whether the collector and duct work are airtight;
- measuring the airtightness of the house;
- checking the proper working of the installations (functioning, noise, quantities of air, heating rate).

The measuring arrangements are designed in such a way that the energy output of the hybrid system (solar collector, hollow concrete floor and solar boiler) can be measured and can be computed in an energy scale.

In the seven houses with a hybrid system and the seven reference houses, electricity meters, gas meters and gauges for the water capacity have been installed to determine the consumption of the electricity for the additional energy and the hot water consumption.

### 5.3 MONITORING RESULTS

From October 1986 to April 1988, a measuring program was carried out in the solar houses. The measuring program consisted of meter reading in seven solar houses and seven reference houses, as well as detailed measurements in seven solar houses.



Using the meter readings, the average consumption of gas and electricity was determined. The heating degree-days during the measuring period, between June 1, 1987 and May 31, 1988, proved to be about 20% lower for Hoek van Holland than during the past 10 years at De Bilt.

METER READINGS

consumption	solar houses	reference houses
gas in m <sup>3</sup> per annum	1194	1496
electricity in kWh per annum		
- auxiliary solar system	320	-
- domestic use	2156	2715
- total electricity	+ ----- 2476	+ ----- 2715

Table 3: Average total consumption of gas and electricity of the houses (meter readings between June 1, 1987 and May 31, 1988, location Hoek van Holland)

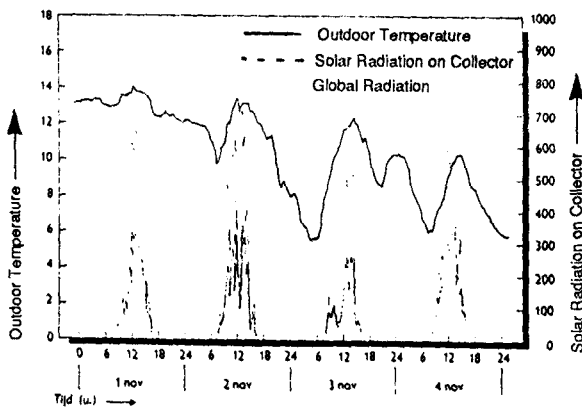

Outdoor temperature and solar gain on some typical fall days (1-4 november 1987)

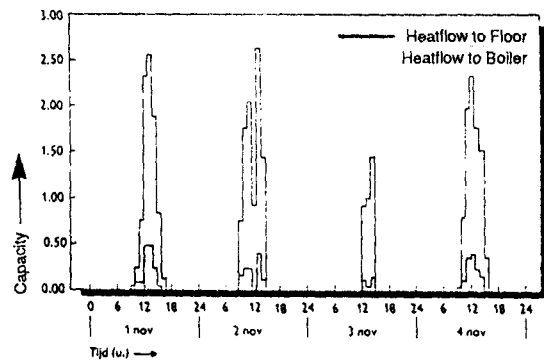

Energy flow (capacity) to the storage tank and the first floor on some typical fall days (1-4 november 1987)

At first occupants were rather skeptical and reserved about the solar system, because it takes too much space in the attic, and because of the investment in relation to the expected savings. because the fans for the collectors are attached to the wooden roofboarding, there is a sound problem (circa 40dB), comparable with that of airheating. The system has now been fully accepted by the occupants.

5.4 OCCUPANT EVALUATION

## 6.0 ECONOMICS

### 6.1 ADDITIONAL CONSTRUCTION COSTS

The extra investment for the seven solar houses are:

- extra insulation	f.	6000,--
- solar collectors	f.	73000,--
- piping	f.	28000,--
- extra constructional supplies	f.	21000,--

Total for seven dwellings	:	f.	121000,--
Per dwelling	:	f.	17300,--

Subsidy per dwelling	:	f.	7000,--
----------------------	---	----	---------

Net investment per dwelling	f.	10300,--
-----------------------------	----	----------

The total building costs are f. 145000,-- per dwelling (incl. f. 30000,--site costs).

With the solar system, the energy savings are 225 m<sup>3</sup> natural gas per dwelling per year (f. 110,--/year); this is approximately 1% of the investment. The auxiliary energy requirement is 320 kWh electricity.

## 7.0 CONCLUSION

The solar house has an energy consumption of 1600 kWh less (225 m<sup>3</sup> natural gas) than the reference house; the saving per annum amounts to f 140,-- compared to an investment of f 10.000,--.

The contribution of the solar system to the space heating load is very small compared to that to the hot-water supply (solar boiler), and the contribution of the floor system (heat storage) to the total energy saving is very small in comparison to that of the solar boiler.



## 1.0 GENERAL

The project consists of a single family, detached dwelling located near Oslo at Lørenskog. The small site is within an area of new single family dwellings and multi family houses. Its main energy design features are a sunspace that acts as a preheater for ventilation air, a heat pump that uses exhaust air to heat domestic water, and super insulation / air tightness.

## 1.1 PROJECT DESCRIPTION

<b>Architect:</b>	Arkitektkontoret GASA A/S Oslo School of Architecture
<b>Energy and Monitoring Consultant</b>	Norwegian Building Research Institute (NBI) Rådg. ing. Lars Myhre Rådg. ing. Kåre Nybø
<b>Contractor:</b>	Kjell Støfring A/S
<b>Sponsor:</b>	The Royal Norwegian Council for Scientific and Industrial Research, Private industry

## 1.2 PARTICIPATING ORGANISATIONS

Documentation of the Norwegian IEA project at Lørenskog can be found in the following reports:

## 1.3 PROJECT REPORTS

*The Norwegian IEA task VIII: Passive Solar Homes,*  
A.G. Hestnes and T. Jacobsen. Proceedings of the 13th National Passive Conference,  
Cambridge, Mass., June 1988.

*Oslo School of Architecture: Current Research Projects,*  
Red.: T.T. Evensen, AHO 1986.

*Monitoring Results,*  
Tormod Aurlen, NBI 1988.

## 2.0 CONTEXT

The project is intended to demonstrate to the building community a state-of-the-art passive and hybrid solar energy dwelling combined with super insulation and air tightness. The house is designed for Norwegian climatic conditions and adapted to the local middle income market.

### 2.1 DESIGN OBJECTIVES

### 2.2 LOCATION



**Latitude:** 59.6 °N, **Longitude:** 10.4 °E, **Altitude:** 225 m above sea level

### 2.3 CLIMATE

The climate is in general cold with a long heating season.

## 3.0 DESIGN

Degree days (base 17h°C):	3774 HDD
Ambient temp. (annual):	5.4 °C
Sunshine hrs.:	1756 HRS

### 3.1 ARCHITECTURAL DESIGN

The dwelling consists of two stories plus a loft. The main living area and kitchen is located on the first floor, while the bedrooms are located on the ground floor. The south oriented sunspace is located between the living and dining areas on the first floor and between the bedrooms on the ground floor. It has a horizontal separation between the ground and first floor, with air valves for circulation of solar heated air. An insulated roof provides shading and low heat loss from the sunspace. The sunspace provides daylight to surrounding areas, and the amount of window area is reduced compared to conventional buildings. The design provides open, flexible spaces, and several partition arrangements are possible. Heated floor area is 155 m<sup>2</sup> (volume:400 m<sup>3</sup>), while the sunspace floor area consists of two equal areas, each 10.8 m<sup>2</sup>.

### 3.2 ENERGY DESIGN

#### DIRECT GAIN

The building has maximum south exposure, with the sunspace using approximately one third of the south elevation. All windows are triple glazed, *except* the windows in the sunspace which are double glazed.



south

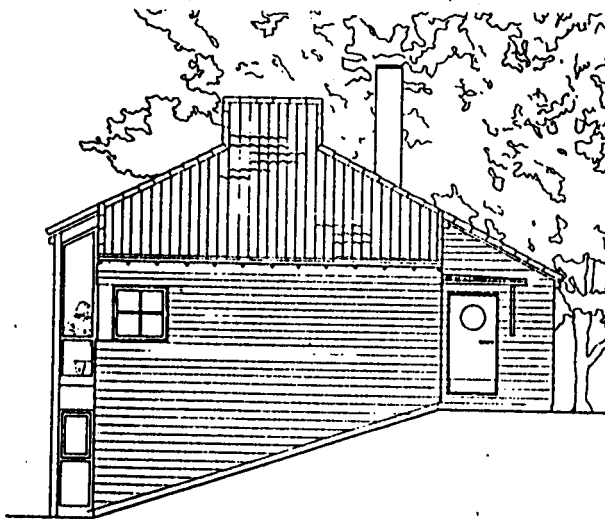

east

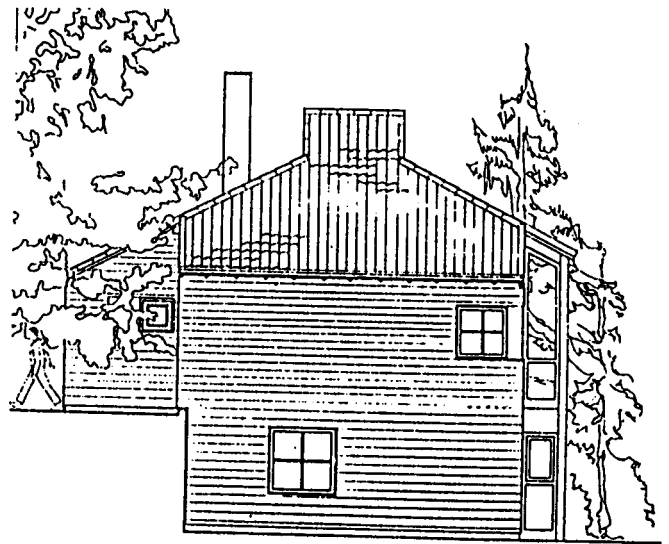

west

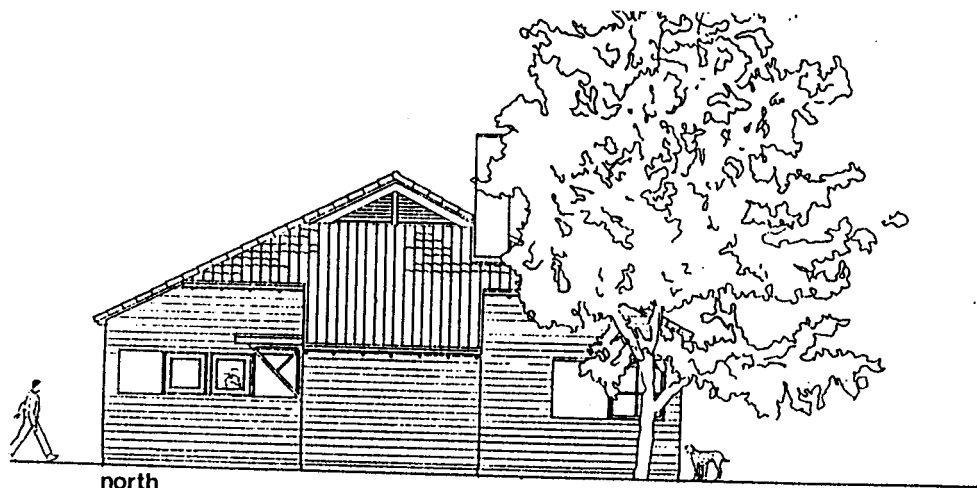

north

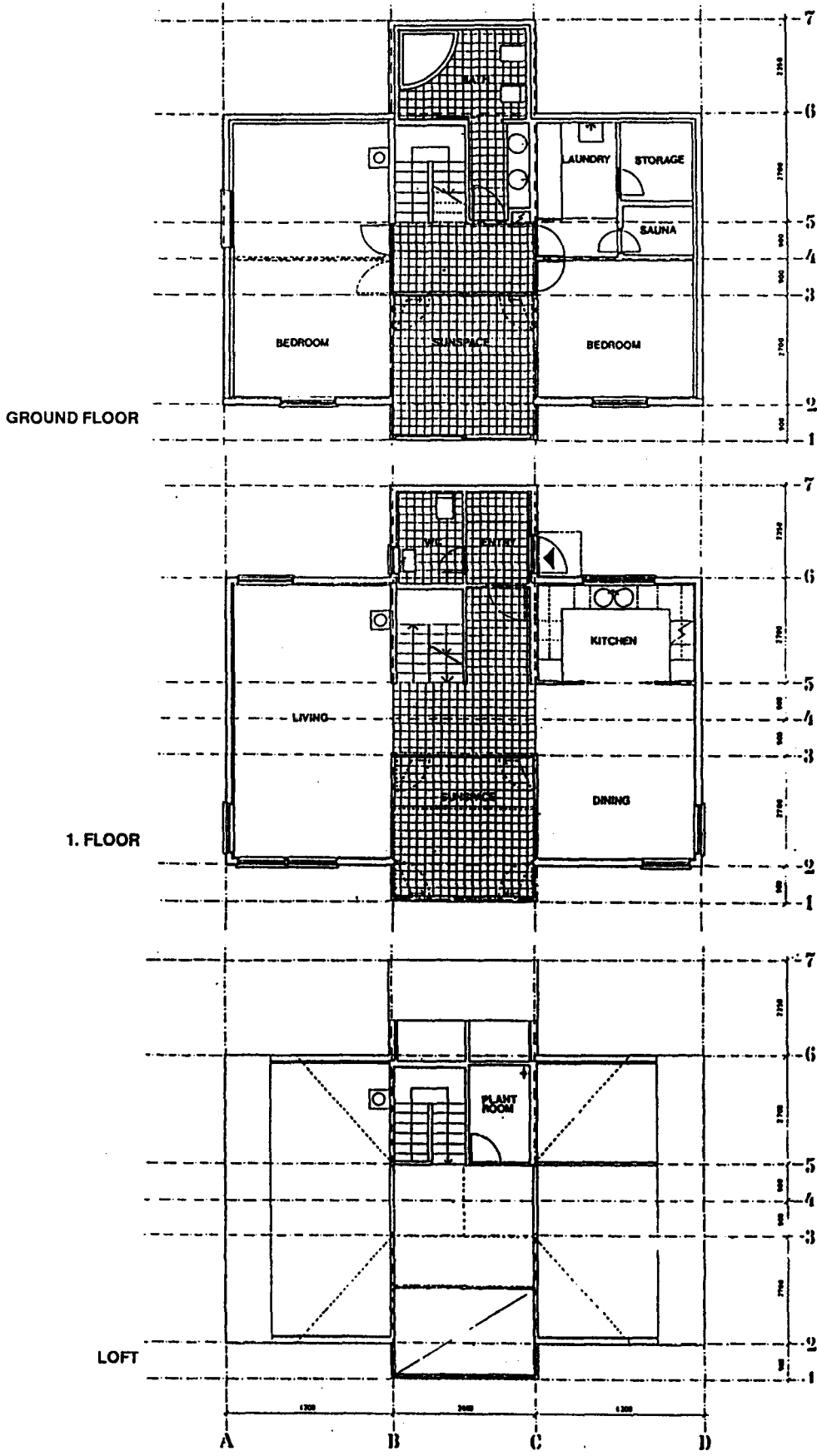

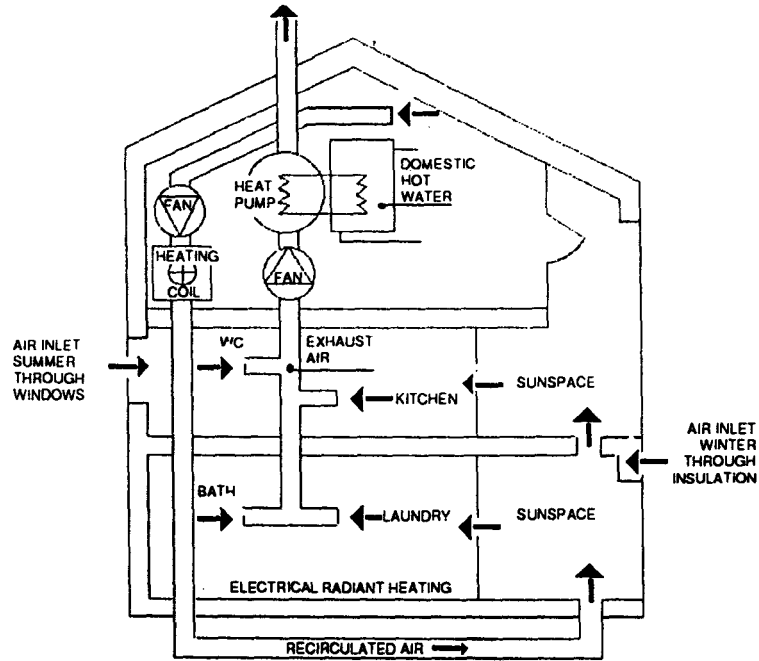

System Diagram

The dwelling is well insulated with 200 mm mineral wool in the walls and 300 mm in the roof. Special attention was paid to the detailing to obtain a high degree of air tightness. The vapour barrier was welded and placed 50 mm from the inside of the wall to avoid damage during later installation of electrical cables. After construction the house was scanned with an infrared camera and the small leakage points found were sealed.

INSULATION /AIR TIGHTNESS

The dwelling is primarily constructed in wood. Masonry floor tiles in the sunspace are directly exposed to sunlight in order to store heat and reduce temperature fluctuations.

THERMAL MASS

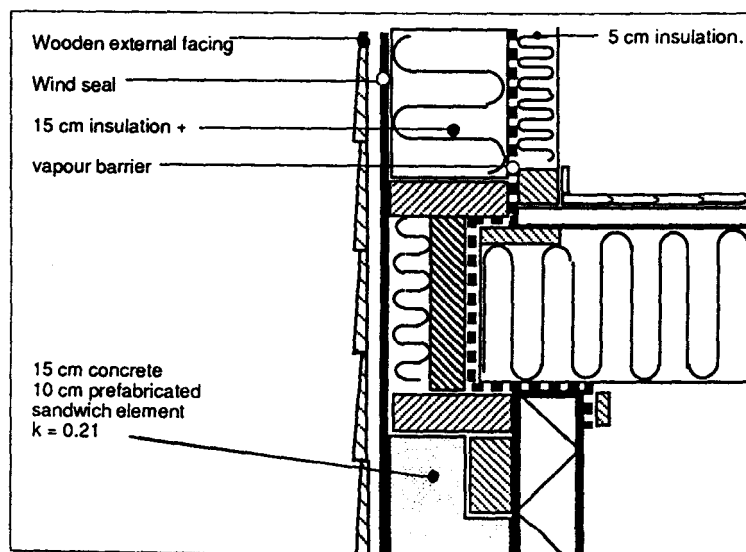

**ZONING** The design permits a high degree of thermal zoning between the different spaces. The sleeping and living areas are on different floors to allow for different temperature requirements.

**SUNSPACE** The solar energy gained is used to heat the sunspace and thereby reduce the heat loss from the adjoining rooms, as well as to pre-heat ventilation air. All ventilation air is drawn from the sunspace during the heating season.

**DOMESTIC HOT WATER** The exhaust air is transported via a heat pump to provide hot water. The heat pump is cost effective. It does not compete with the solar system.

**4.0 ANALYSIS**

Parameter studies were carried out during the design stage with the ENCORE computer program. The results showed that a sunspace would reduce the energy consumption by about 13 %. In the calculations the solar dwelling was compared to a reference building with the same shape but without the sunspace. The reference building was insulated according to standard practice, i. e., 150 mm mineral wool in the walls, 200 mm mineral wool in the roof and triple glazing. The results predicted that the solar dwelling would use 30 % less energy for space and water heating than the reference building. The sunspace accounted for approximately 1/3 of this saving while increased insulation and the heat pump accounted for the rest. The results also showed that the temperature in the sunspace should be 10-15 °C higher than the ambient temperature, and consequently that the sunspace could be used for ordinary occupancy at least 9 months of the year.

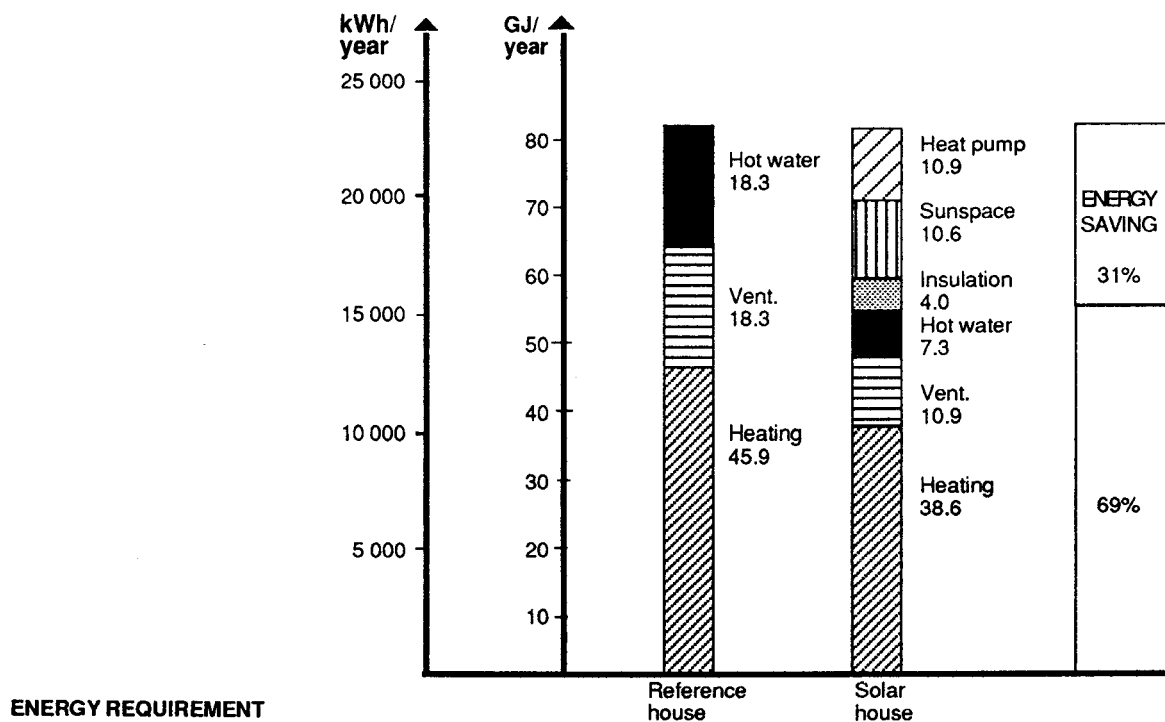



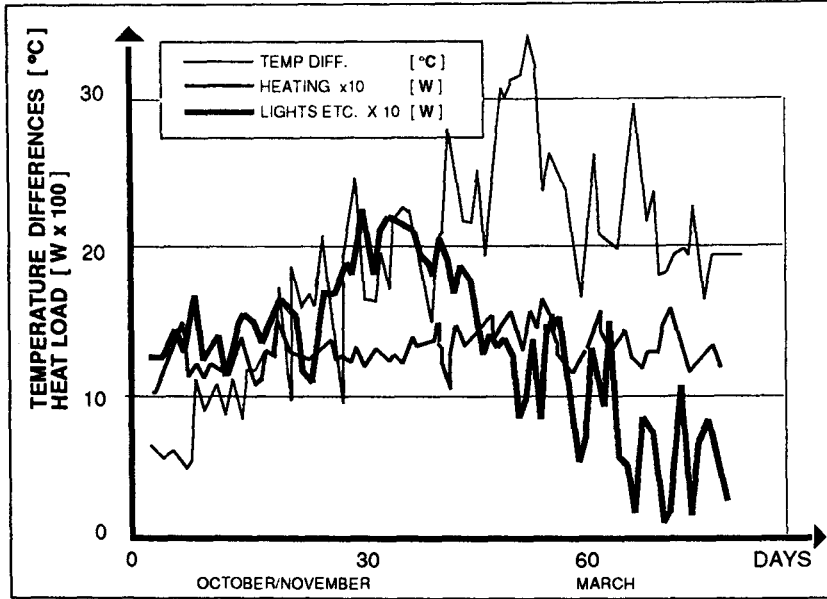

HEAT DEMANDS COMPARED TO TEMPERATURE DIFFERENCES

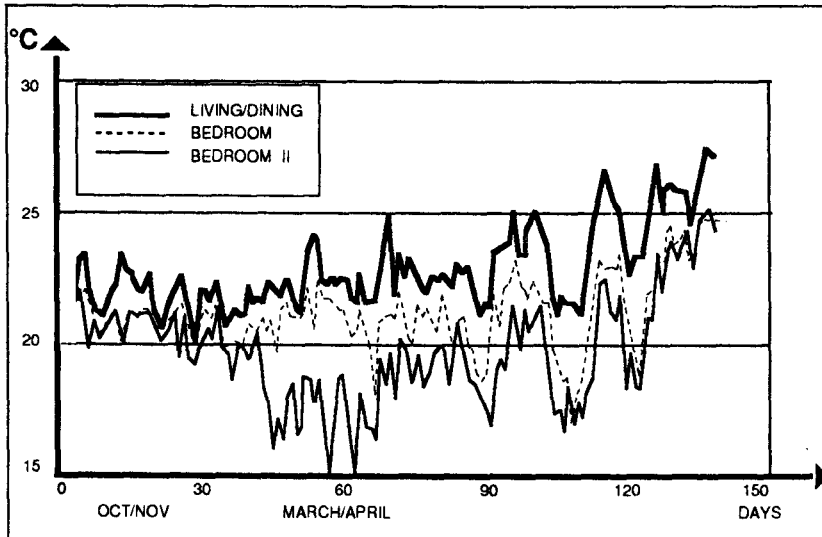

INDOOR TEMPERATURE VARIATION

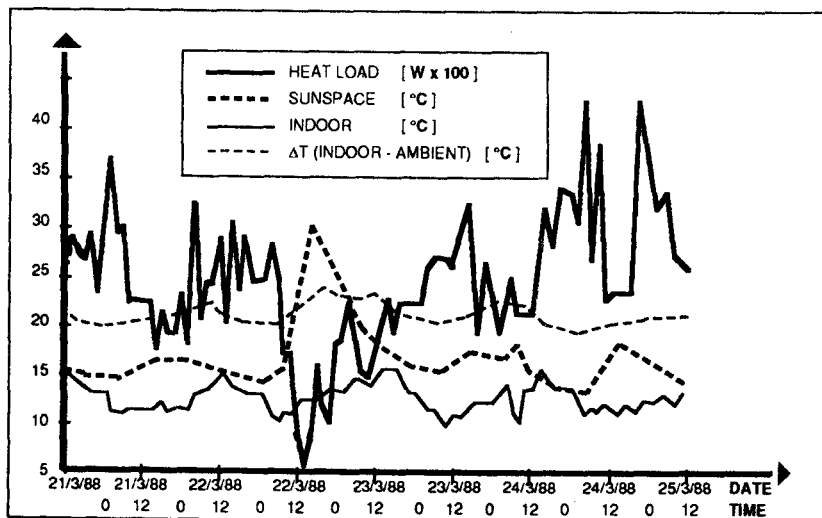

CORRELATIONS BETWEEN HEAT LOAD, INSOLATION AND TEMPERATURES

ENERGY CONSUMPTION (kWh)

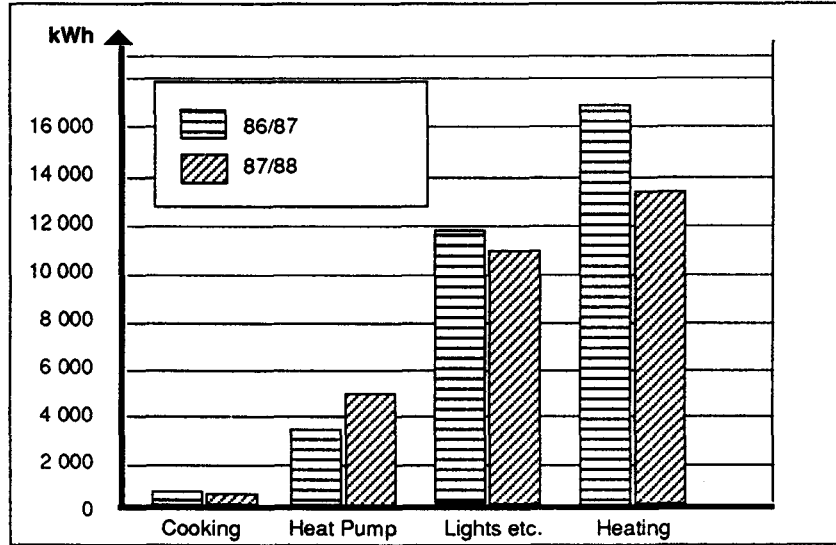

AVERAGE POWER DEMAND IN EACH REGISTRATION PERIOD

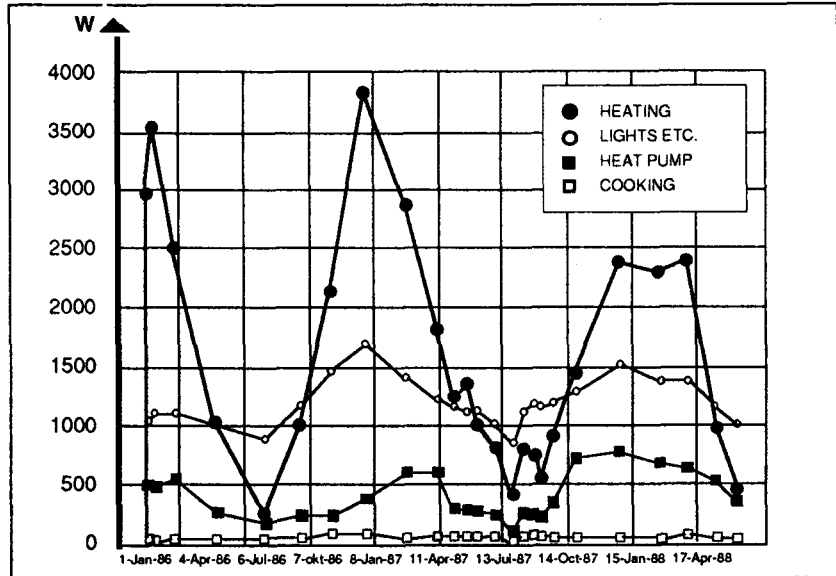

CORRELATION BETWEEN HEAT LOAD AND INSOLATION

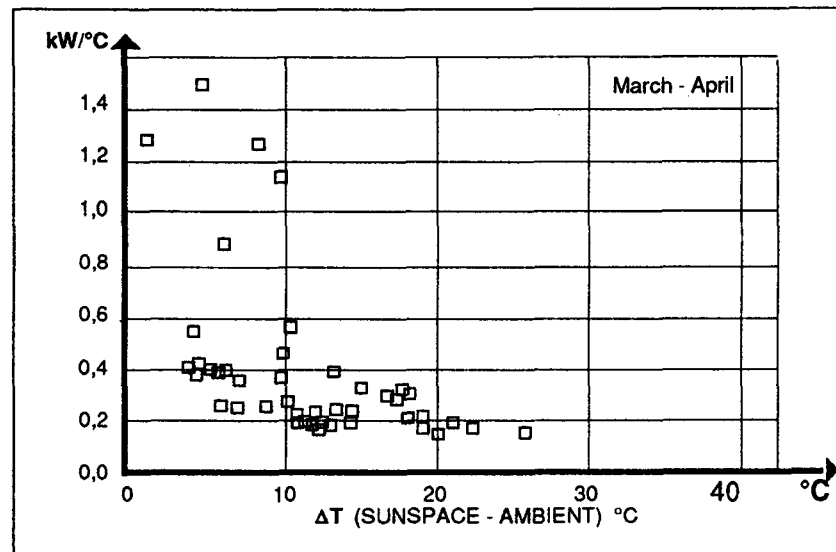

The monitoring objectives are to verify the research results and information obtained in other parts of the project, to optimize the reduction in heating load and consumption of non-renewable energy, and to assess the usability of the sunspace.

The data acquisition equipment consists of a DELTA datalogger. The data are processed in a Macintosh II micro computer and collected and stored every 60 minutes. Averages or totals are stored in memory. Continuous measurements include:

<b>Energy consumption parameters:</b>	Total electric power, electrical consumption by end use, hot water, venting status.
<b>Interior temperatures parameters:</b>	Dry bulb temperatures in all rooms, globe temperatures in sunspace and living room, dry bulb temperatures in supply and exhaust air ducts, temperature in hot water tank.

One time measurements include:

<b>Air tightness parameters:</b>	N—50 pressurization test, tracer gas air change measurements.
----------------------------------	---

The actual air change rate in the dwelling was measured with the mechanical system running. The results show a ventilation rate of between 0.37 and 0.48 ach, depending on the fan speed (stage 2 and 3). During the monitoring period the indoor temperature was 24-26 °C, far above predicted (20 °C). Total energy consumption for heating, cooking, hot water, lights and appliances was 28.000 kwh/year (1987/88). Lights and appliances count for 10.500 kwh alone, while 13.000 kwh are used for heating. The results for heating are close to predicted (13.500 kwh/year). The heat pump provides 4.500 kwh/year.

Indoor and sunspace temperatures:

The temperature level in the dwelling itself has on the average been higher than estimated, i.e. 20 °C. The temperature in the living areas has been 24-26 °C, and in the bedrooms 18-22 °C. The sunspace temperature has been between 15 and 27 °C.

The occupants are quite happy with the house. They find that they can use the home in much the same way as they have used their previous homes. The two-story sunspace is used both for living, dining, as a balcony (windows opened) and as a play space for children. It also provides daylight to the surrounding spaces.

## 5.0 MONITORING

### 5.1 MONITORING OBJECTIVES

### 5.2 MONITORING SYSTEM

### 5.3 PERFORMANCE RESULTS

### 5.4 OCCUPANT EVALUATION

SUNSPACE TEMPERATURES  
AUTUMN / SPRING

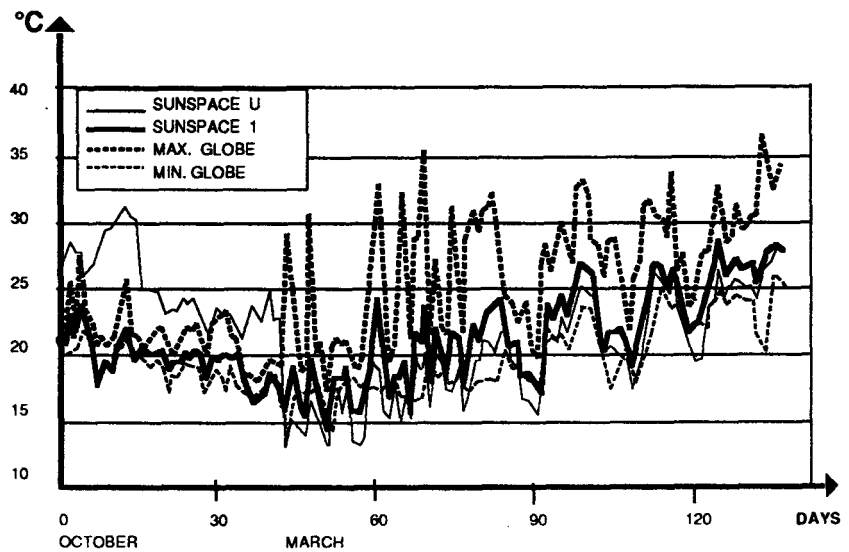

## 6.0 ECONOMICS

Cost figures on different building components have been difficult to obtain. The total cost for the building is NOK 950.000 (US \$ 142.000), which is relatively inexpensive compared to traditionally built houses. It is possible to say that increased insulation and air tightness combined with heat pump/ventilation system and a sunspace built with conventional windows is cost effective.

## 7.0 CONCLUSION

This project demonstrates that energy savings are possible in a solar dwelling with a sunspace combined with super insulation and a heat pump. However, special considerations should be put into designing sunspaces. The use of traditional wooden windows is cost effective, but has its limitations. Traditional greenhouse components may also be used. Today more sophisticated steel and aluminium sunspace constructions is far too expensive in single family dwellings.

## 1.0 GENERAL

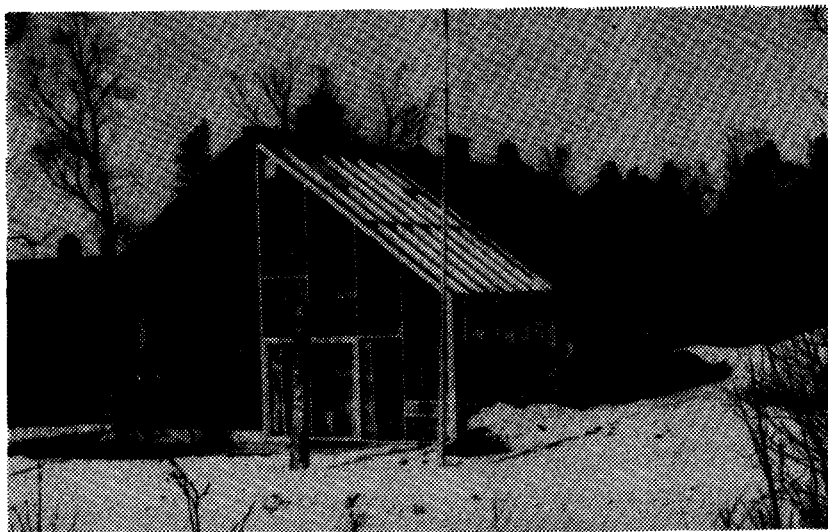

The project consists of a single family, detached dwelling located on a flat site in Malvik outside Trondheim. Its main energy design features are a sunspace that acts as a preheater for ventilation air and a heat pump that uses exhaust air to heat domestic water.

## 1.1 PROJECT DESCRIPTION

**Architect:** SINTEF division of Architecture and Building Technology  
N-7034 Trondheim

**Energy and Monitoring Consultant:** SINTEF division of Applied Thermodynamics  
N-7034 Trondheim

**Contractor:** Ola Frost A/S  
Erling Skakkes gt.2B  
N-7000 Trondheim

**Sponsor:** The Royal Norwegian Council for Scientific and Industrial Research, Private industry

## 1.2 PARTICIPATING ORGANIZATIONS

Documentation of the Norwegian IEA project at Malvik can be found in the following reports:

*IEA Task VIII: Passive and Hybrid Solar Low Energy Buildings. National Report Subtask D. Program and Design Phase. SINTEF report no. STF62 A85017, Trondheim, 1985*

*Passive Solar Design in Norway - an IEA Example,*  
T.Jacobsen and A.G.Hestnes, Proceedings of the North Sun'86 Conference, Copenhagen, June 1986

*The Norwegian IEA Task VIII Passive Solar Homes,*  
A.G.Hestnes and T.Jacobsen, Proceedings of the 13th National Passive Conference, Cambridge, Mass., June 1988

## 1.3 PROJECT REPORTS

**2.0 CONTEXT****2.1 DESIGN OBJECTIVES**

The project is intended to demonstrate to the building community a state-of-the-art passive and hybrid solar low energy dwelling designed for Norwegian climatic conditions and adapted for the local, middle income market.

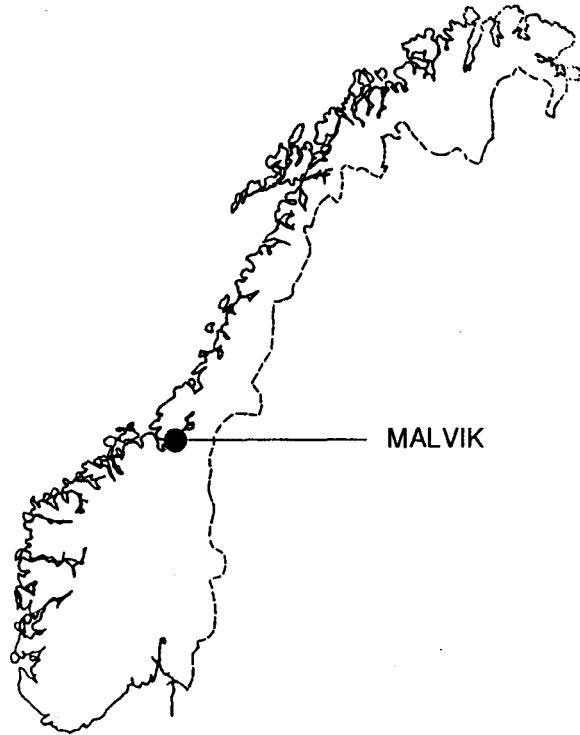
**2.2 LOCATION**

Latitude: 63.3°N, Longitude: 10.3°E, Altitude: 100 meters above sea level

**2.3 CLIMATE**

The climate is in general cold, with a long heating season and with low levels of radiation. In the most severe winter months, there is very little radiation even though the skies are often cloudless. In the summer months the skies are often cloudy.

Average temperature	4.9°C	Degree days (18°C Base)	4799 HDD
Average winter temperature	0.3°C	Global irradiation	3280 MJ/m <sup>2</sup>
Average summer temperature	11.3°C	Diffuse portion	app. 50
Average annual relative humidity	80 %	Sunshine hours	1350

**3.0 DESIGN**  
**3.1 ARCHITECTURAL DESIGN**

The dwelling consists of one story plus a loft and a basement. The main living area, with living room, kitchen, and two bedrooms, is located on the ground floor, while a third bedroom and a study are located in the loft. The kitchen and sunspace are positioned to receive sunlight in the morning and the living room is positioned to receive sunlight in the afternoon/evening. The heated floor area is 140 m<sup>2</sup>, while the sunspace floor area is 25 m<sup>2</sup>.

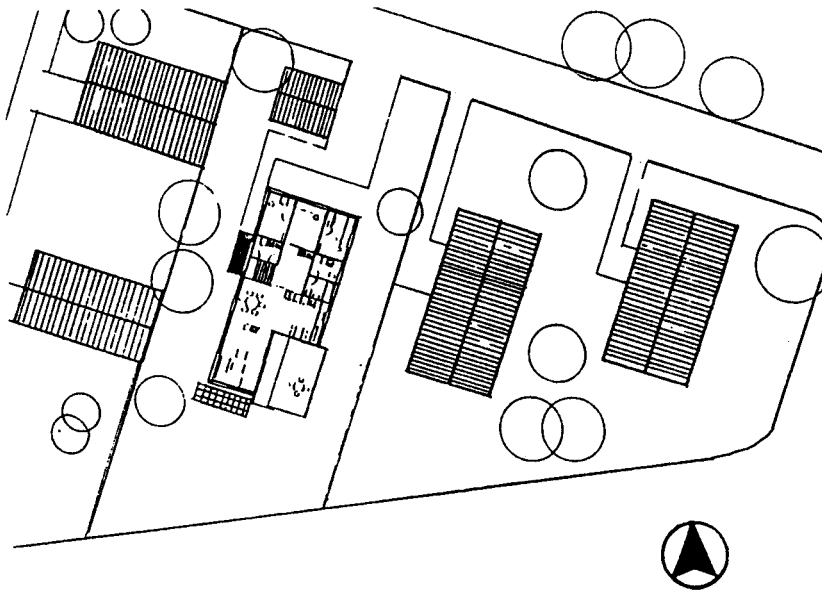

Site Plan

The size and shape of the dwelling is largely determined by zoning regulations, which severely limited the possibilities for southern exposure. As it was considered desirable to have some windows in the living room providing a direct view to the south, only half of the relatively small south facade is used for the sunspace. The other half, as well as the south end of the west facade, have large direct gain windows. The windows are all triple glazed.

The dwelling is well insulated, with 200 mm mineral wool in the walls and 250 mm mineral wool in the ceiling. Emphasis was put on obtaining a high degree of air tightness by paying special attention to detailing. This was limited by the contractor's need to use standard components and construction techniques.

The dwelling is basically constructed in wood, with a brick exterior finish. Brick was introduced to obtain a high mass building, but because the Norwegian masons at present only use brick as veneer, the use of brick on the interior was limited to the living room and the sunspace. In these cases it is directly exposed to sunlight and will therefore reduce temperature fluctuations.

The shape of the dwelling permits a high degree of thermal zoning. The living, service, and sleeping areas are separated, with the living and sleeping areas at opposite ends of the house. It is therefore possible to allow for different temperature requirements.

**3.2 ENERGY DESIGN**

**DIRECT GAIN**

**INSULATION/  
AIR TIGHTNESS**

**THERMAL MASS**

**ZONING**

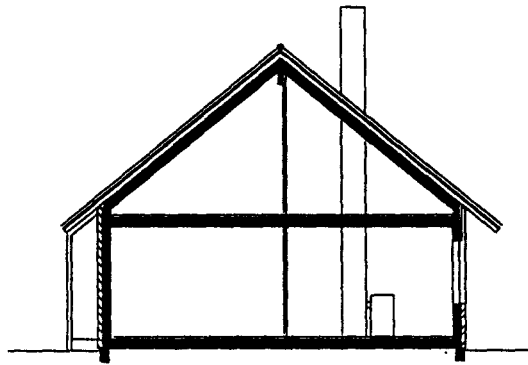

Section A A

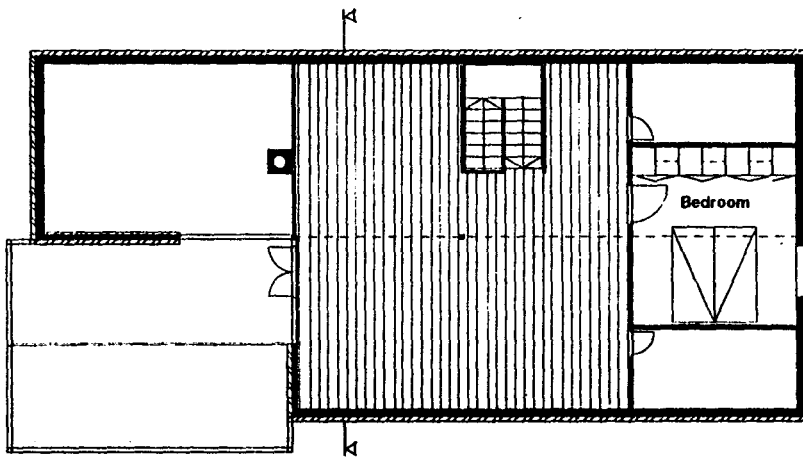

Plan Loft

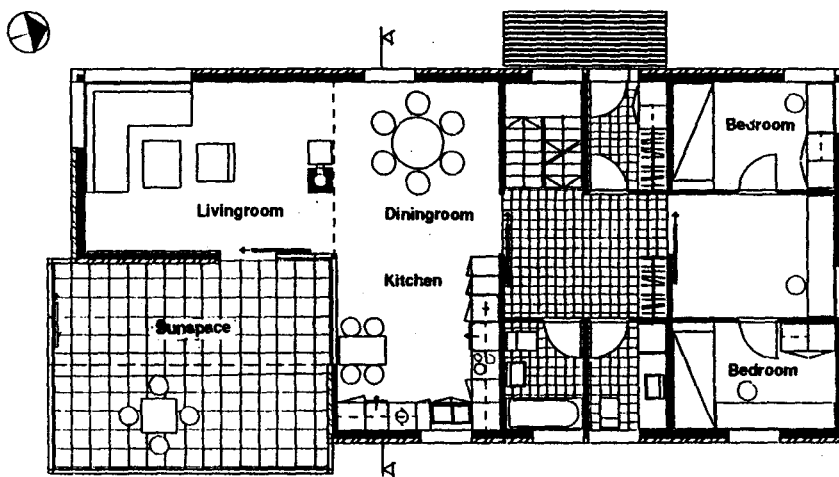

Plan Ground Floor



The sunspace has thermal mass on the floor and on parts of the walls and is located in the south east corner of the dwelling. The energy gained is used to heat the sunspace itself, to reduce the heat loss from the adjoining parts of the dwelling, and to heat the ventilation air. All ventilation air is therefore transported via the sunspace with the help of fans. The amount of air moved is 250 m<sup>3</sup>/h. If the temperature in the sunspace is too high, the air is taken into the dwelling via a by-pass duct.

**SUNSPACE**

**PREHEATING  
VENTILATION AIR**

The air circulation system allows for separate control of the different zones, with relatively more air being supplied to the bedroom zone as 0.50.6 ach/h is not considered to be adequate there. This eliminates the need for window venting during the heating season.

**AIR CIRCULATION**

The exhaust air is transported via a heat pump, heating domestic hotwater. The heat pump was included because it does not compete with the solar system, and because cost effective products exist on the market.

**DOMESTIC HOT WATER**

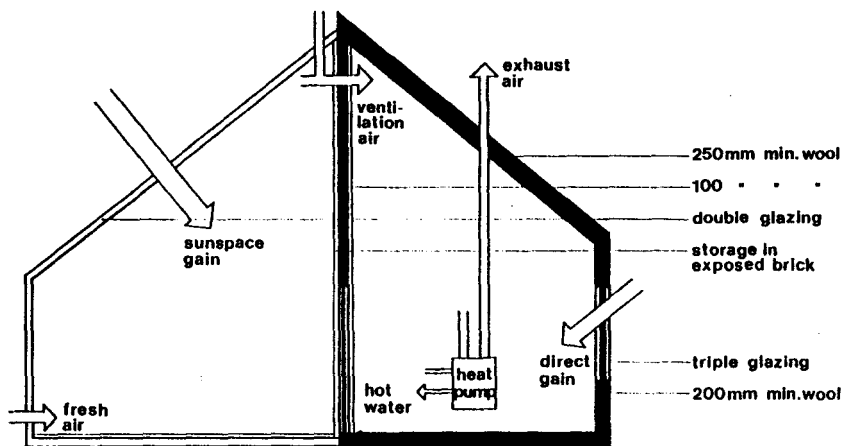

System Diagram

Parameter studies were carried out during the design stage with the computer program ENCORE. The results showed that a sunspace would reduce the energy consumption by about 20 %, that the sunspace had to have a transparent roof, that a south east corner sunspace performed as well as a purely southfacing one, that added mass primarily reduced temperature fluctuations and was necessary for that purpose both in the sunspace and in the dwelling, and that night insulation was not cost effective.

**4.0 ANALYSIS**

Calculations for the final design were carried out with the programs ENCORE, SERIRES, and TARP. The results are relatively similar.

In the calculations the solar dwelling is compared to a reference building with the same shape but without the sunspace. The reference building is insulated according to standard practice, i.e., 150 mm mineral wool in the walls, 200 mm mineral wool in the ceiling, and triple glazing.

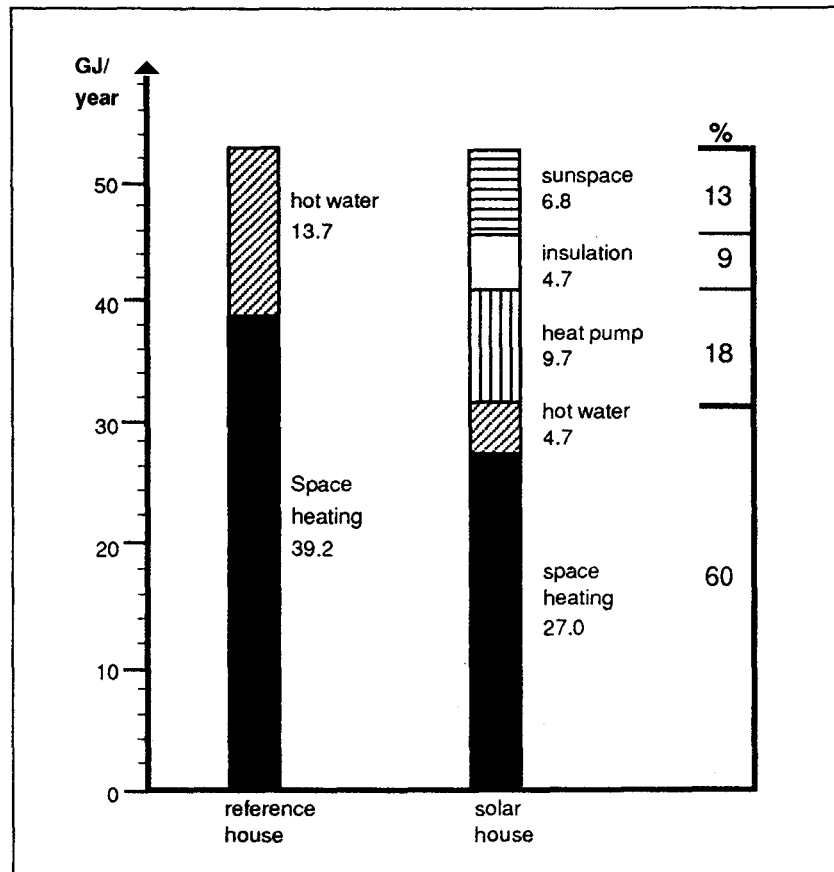

Total Heating Requirement

The results predicted that the solar dwelling would use 40% less energy for space and water heating than the reference building. The sunspace accounted for 1/3 of this saving, while the increased insulation and the heat pump accounted for the rest. The results also showed that the temperature in the sunspace should be 5-10°C higher than the ambient temperature, and consequently that the sunspace could be used for ordinary occupancy at least 6 months of the year.

The monitoring objectives are to test the research results and information obtained in other parts of the project, to assess the reduction in heating load and the consumption of non-renewable energy of the passive solar dwelling compared to a conventional dwelling, and to assess the year round comfort in and usability of the sunspace.

The data acquisition equipment consists of a datalogger connected to a microcomputer (HP-150B). The data are processed in a minicomputer (VAX-8600). Data are collected every 30 minutes and averages or totals are stored in memory.

Continuous measurements include:

**Climatic parameters:** Solar radiation (global and diffuse), temperature, and wind speed.

**Energy consumption parameters:** Total electric power, electricity consumption by end use, hot water, venting status.

**Interior temperature parameters:** Dry bulb temperatures in all rooms, globe temperature in sun space and living room, dry bulb temperature in supply and exhaust air ducts, temperature in hot water tank.

One time measurements include:

**Air tightness parameters:** N-50 pressurization test, heat loss factor test, air change measurements.

The results of the air tightness tests show an air change rate of 3.3 ach at +/-50 Pa, with ambient temperature -2°C, windspeed 1-2 m/s, and indoor temperature 20°C. The Norwegian standard requires 4.0 ach. A recent study of 70 new, single family dwellings show an average leakage rate of 4.6 ach.

The actual air change rate in the dwelling is measured with a tracer gas technique, both with and without the mechanical system running. The results show a ventilation rate of 0.35 ach without the mechanical ventilation, and 0.67 ach with the system running, with ambient temperature -1°C, windspeed 2-5 m/s, and indoor temperature 20°C.

The performance results show that the energy consumption is close to predicted. Energy consumption for heating for the season 1987/88 was 28.4 GJ, while the predicted consumption was 27.0 GJ. Total energy consumption, for heating, hot water, lights and appliances, was 70.9 GJ, while the predicted value was 67.3 GJ.

The preheating of ventilation air in the sunspace provides approximately 12.6 GJ. Solar gains account for 9.4 GJ, while recovered transmission losses account for the rest. The heat pump provides approximately 10.8 GJ.

## 5.0 MONITORING

### 5.1 MONITORING OBJECTIVES

### 5.2 MONITORING SYSTEM

## 5.3 PERFORMANCE RESULTS

### ENERGY CONSUMPTION

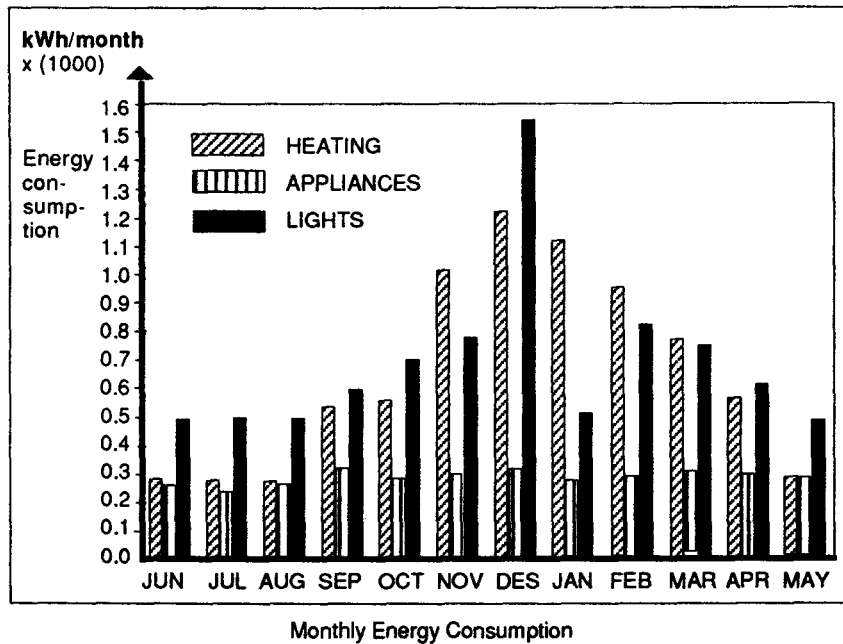

Monthly Energy Consumption

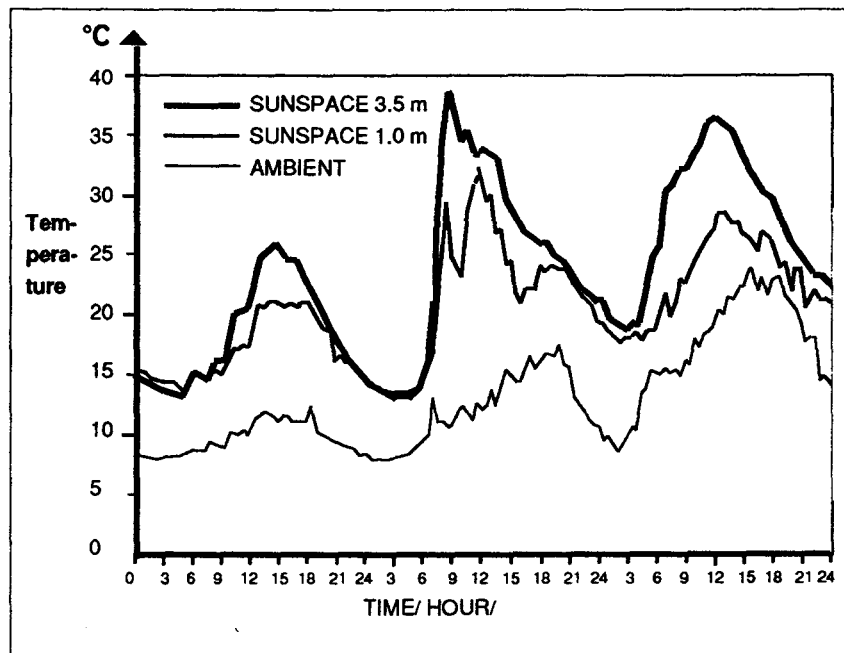

Sunspace and Ambient Temperatures June 22-24, 1986

SUNSPACE TEMPERATURES

The temperature level in the dwelling itself has on the average been as estimated, i.e. 20°C. The temperature in the bedrooms has been 15-16°C, and in the living areas 21-22°C. There has not been any problems with overheating or thermal stratification even though the loft is coupled to the living room downstairs. This is partly due to the position of the ventilation inlets in this part of the dwelling.

The sunspace has also not had any problems with overheating. This is partly due to its position, to its height and resulting thermal stratification,

and to the use of thermal mass. A similar sunspace nearby, with no added thermal mass, but with extensive airing, showed temperatures of 35-40°C on the same days.

Lowest registered temperature in the sunspace is -4°C, at an ambient temperature of -15°C. The average temperature in the sunspace in January was +1°C, with an ambient average of -5°C.

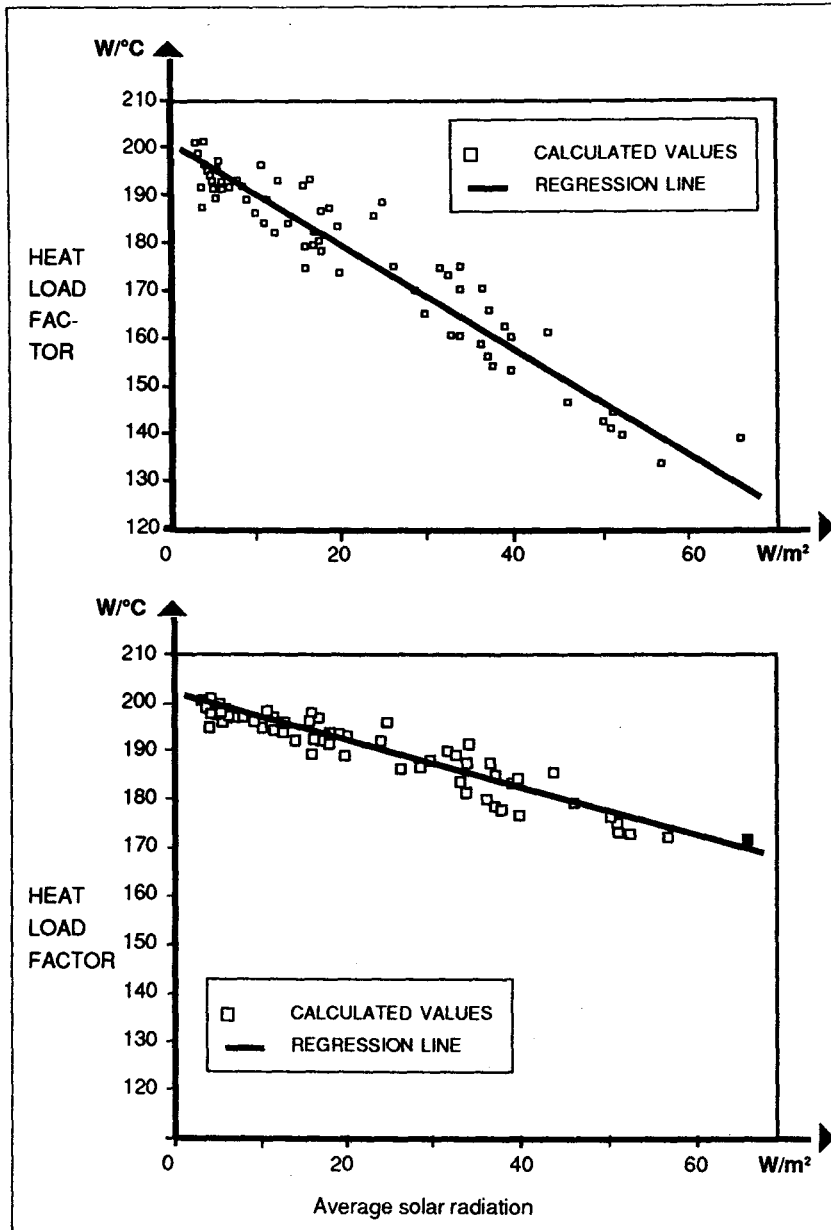

Heat load factors for the solar dwelling (a) and the reference dwelling (b). All dwellings have the same heat load factor at zero solar radiation.

HEAT LOAD FACTORS

In order to see how solar radiation affects the heating load in the measured house and the calculated house, the average heat load factor for three days is plotted against the corresponding three days average of

global horizontal solar radiation. The month of February has been used, since the heating has been on during all house of that month both in simulations and measurements. This means full use of internal and solar gains during this period. A linear regression has been made for both data sets. This procedure is also carried out for the reference dwelling, and for the precalculations of the solar and reference dwellings. The heat load factor at zero solar radiation is the standard heat loss factor, while the slope of the lines indicates the usefulness of the solar radiation. It also indicates whether the heat capacity, window data etc., are the same in the model and prototype. The slope of the lines indicates the usefulness of the solar radiation. It also indicates whether the heat capacity, window data etc., are the same in the model and the prototype.

#### 5.4 OCCUPANT EVALUATION

The occupants are quite happy with their dwelling. After an initial adjustment period they find that they can use this home in much the same way as they have used their previous homes. Only the sunspace is a new feature, which they enjoy. Even in the middle of the winter they use it as a playspace for the children. In the spring and fall it is a pleasant place to eat lunch and dinner, while in the summer it is best suited for late breakfasts. In addition, they are now able to grow a much wider variety of crops.

### 6.0 ECONOMICS

#### 6.1 ADDITIONAL CONSTRUCTION COST

Cost figures have been difficult to obtain and are partly based on data from other local contractors. The additional cost of the solar dwelling when compared to the reference dwelling without the sunspace is estimated to be NOK 210000. This represents approximately 30 %of total construction costs. The additional costs are:

Added insulation	NOK 10000
Added thermal mass	" 15000
Ventilation/heat pump system	" 20000
Sunspace	" 165000

---

Total additional cost                      NOK 210000 = ECU 27600

#### 6.2 COST EFFECTIVENESS

An annual energy saving of approximately 20 GJ will never make such an investment cost effective with present prices for energy. Most of the investment is in the sunspace, however, and the amenity value of that space has to be taken into account. With a more reasonable price for the sunspace, it may be possible to say that the total investment, in energy savings measures and in additional space, is cost effective.

### 7.0 CONCLUSION

This project demonstrates that significant energy savings is possible in a solar dwelling with a sunspace, and that such a dwelling will have an increased amenity value. However, the cost of sunspaces is at this point too high to make such dwellings cost effective.

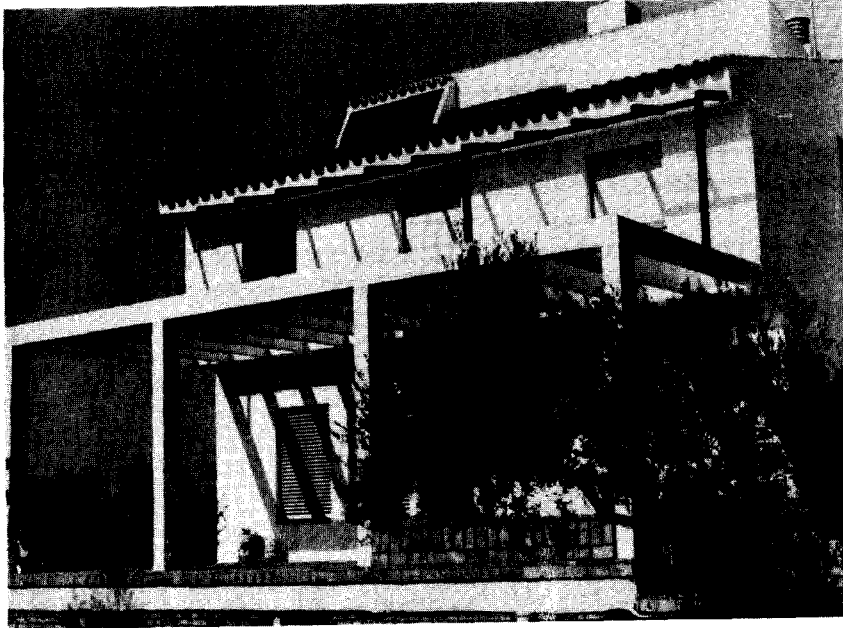

1.0 GENERAL

The Mairena project is a single family house, with integrated active and passive systems, designed to be responsive in a mediterraneancontinental location. Construction of the house was completed in October 1985; monitoring began in February 1986.

The building was constructed under the Spanish Social Housing Programme (VPO) which has stringent conditions on area (90m<sup>2</sup>), volume, construction, design and costs.

The building is a prototype for a 124-unit complex in Osuna (Sevilla).

**Client:** Francisco Cuadrado

**Architect:** Pilar Alberich Sotomayor  
C/Júcar, 11-41012-SEVILLE

**Bioclimatic Consultant:** Seminario de Arquitectura  
Bioclimática (S.A.B.) .E.T.S.A.  
Avda. Reina Mercedes, S/N/-41012-SEVILLE  
(Jaime López de Aslan, José M. Cabeza  
Lainez, Alberto L. Ballesteros Rguez.,  
José Pérez de Lama (Halcón)

**Energy and Monitoring Consultant:** S.A.B. & Valeriano -  
Ruiz, E.T.S.I.I. & ABENGOA, S.A.  
Ingen. Pedro Rodríguez. C/ Infante Don Carlos,  
41013-SEVILLE

1.1 PROJECT DESCRIPTION

1.2 PARTICIPATING ORGANIZATIONS

## 2.0 CONTEXT

2.1 DESIGN OBJECTIVES  
WINTER

The winter design objective is to use passive solar gains and building thermal mass to maintain thermal comfort with a minimal use of auxiliary heating. Also, the design should minimize heat exchange with outside conditions through compact volume and insulation.

## SUMMER

The summer design objective is to prevent overheating during the day through solar protection, thermal mass and insulation of the envelope combined with ventilation in the evening and night.

## 2.2 LOCATION

The project is located near Sevilla in an area of gently rolling hills.

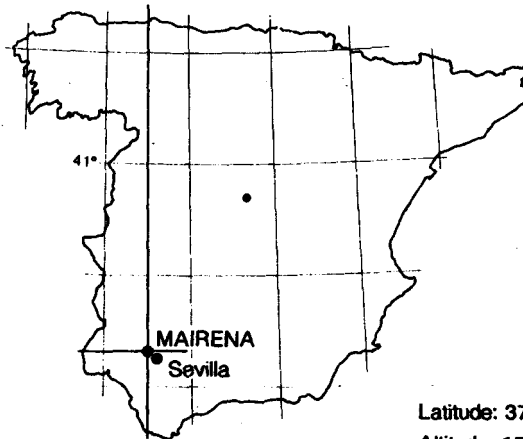

Latitude: 37°N Longitude: 6 °W  
Altitude: 150 m above sea level

## 2.3 CLIMATE

The building is on the "Cornisa del Aljarafe", a topographic elevation to the southwest of Seville where the environmental conditions are milder than in the city.

Global irradiation on horizontal surface:

Oct/Apr	2195 (MJ/m <sup>2</sup> )
Total	5777 (MJ/m <sup>2</sup> )

Hour of sunshine, year - total	3000 h.
--------------------------------	---------

Degree Days (15°C Base)	438 HDD
-------------------------	---------

Average temperature:	Annual	17.3 °C
	Oct/Apr	12.6 °C
	May/Sep	22,0 °C



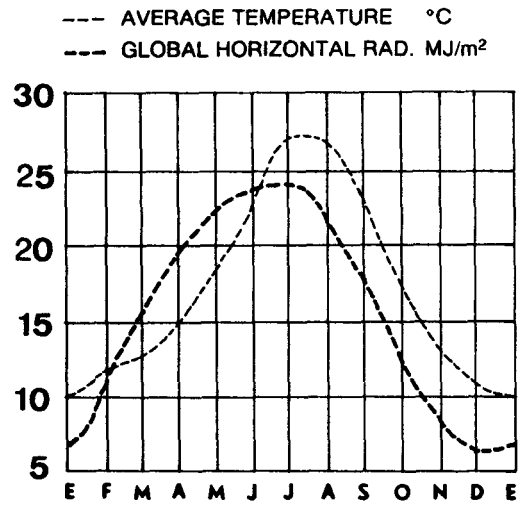

Exterior Conditions

The prototype house was designed for an artist and his family as a year round residence. The intention was to build a house into the natural landscape of "El Aljarafe", an ancient agricultural area, and to give it a simple strong form, like traditional buildings of Mediterranean Spain.

3.0 DESIGN

3.1 ARCHITECTURAL DESIGN

A two storey building with a south facing main façade generates a sequence of functions, with the living room and the 3 bedrooms to the front of the house (South) and staircase, kitchen and bathrooms to the rear (North).

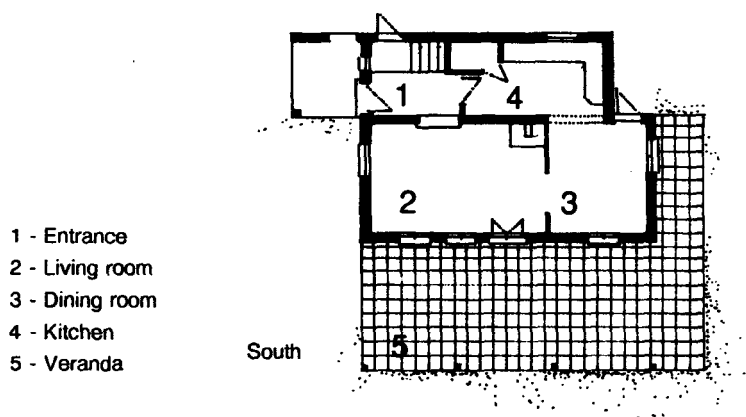

Ground Floor

6 - Bathrooms  
7 - Bedrooms

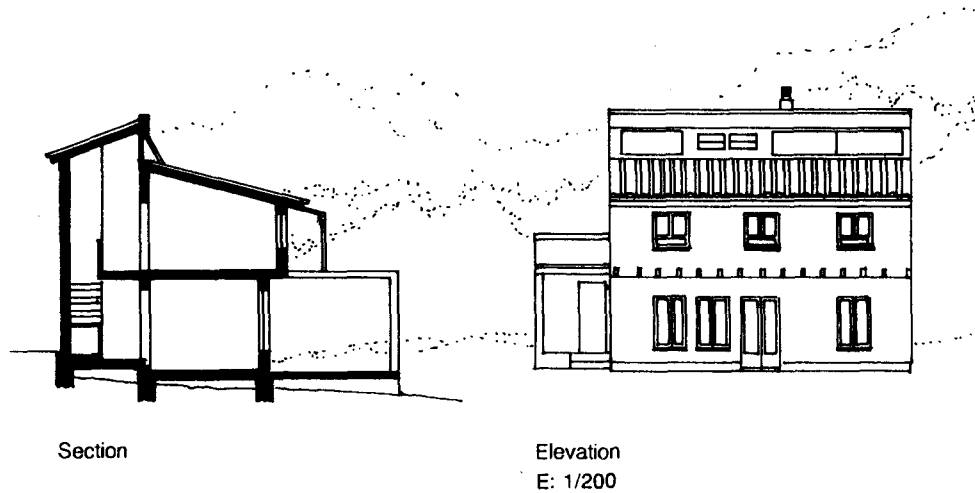
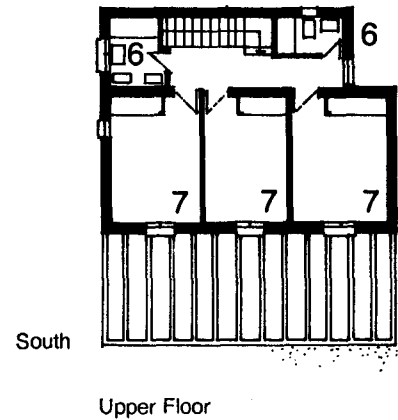

3.2

**ENERGY DESIGN**

The energy and architectural design features of the house are integrated, being actually inseparable.

**WINTER**

High insulation levels and a compact building form reduce overall heat loss; walls are insulated to  $0,58 \text{ W/m}^2 \text{ K}$ , and the ceiling is insulated to  $0,71 \text{ W/m}^2 \text{ K}$ .

The direct solar gain through south windows and a clerestorey provide the main part of the energy required for heating. Thermal mass in the form of heavy brick walls insulated on the exterior plus concrete slab-on-grade floor and heavy furniture and partitions absorb daytime solar gains.

The building has high insulated window shutters to be used at night.

In the centre of the house, an auxiliary fireplace supplies heated air to the upstairs bedrooms by a tube radiator.

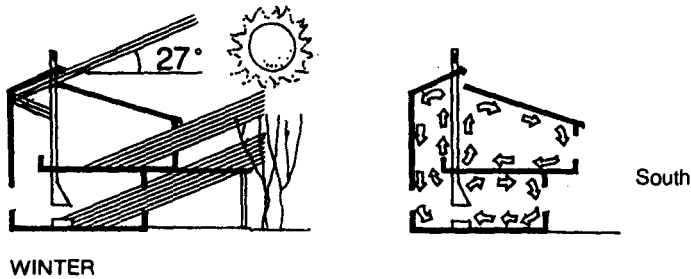

Solar protection is obtained by means of cornices and moveable shutters, designed to provide shading while keeping maximum view out on warm days. The pergola covered with deciduous vegetation creates a sequence of temperatures inside-outside, gives shade during the warm period and refreshes the air.

SUMMER

The windows have been chosen with different colors, textures and dimensions depending on the orientation, considering daylighting and heat transfer needs.

During evening and night the house is cooled by natural ventilation; the clerestory windows are controllable by the occupants to prevent daytime overheating and to improve nighttime air circulation.

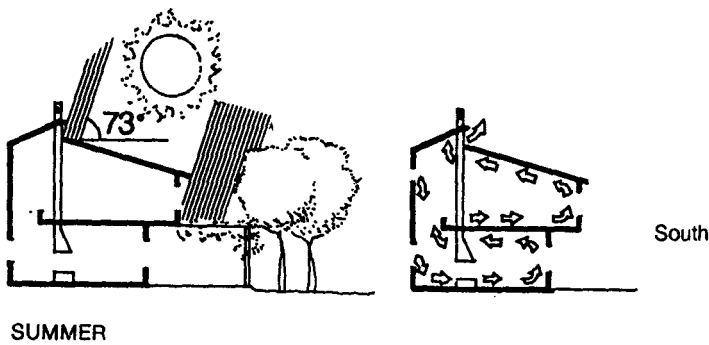

## Construction Details

- 1 - Exterior sheathing and white wash
- 2 - Brick wall 5,3 cm
- 3 - Interior sheathing 1
- 4 - Air space
- 5 - Insulation porexpan 4 cm
- 6 - Interior sheathing 2
- 7 - Brick wall 24,5 cm
- 8 - Interior sheathing 3
- 9 - Concrete slab 23 cm
- 10 - Insulation porexpan 2 cm
- 11 - Flooring
- 12 - Brick wall
- 13 - Foundation
- 14 - Ceramic tiles
- 15 - Sheathing
- 16 - Insulation 4 cm porexpan
- 17 - Concrete slab

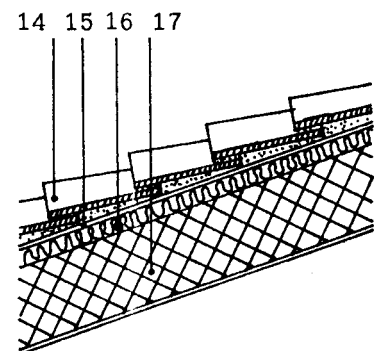
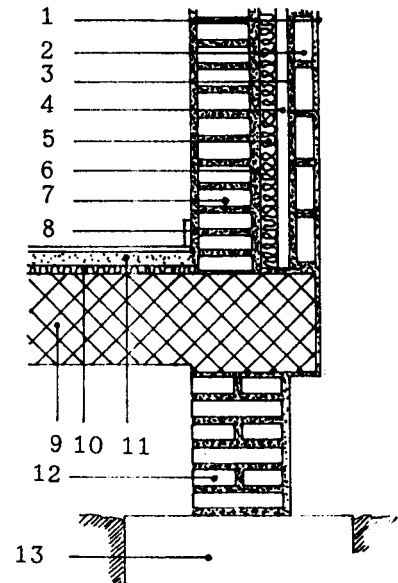

Roof E: 1/20

## 4.0 MONITORING

The monitoring objectives were:

## 4.1 MONITORING OBJECTIVES

1. To evaluate the thermal comfort and daylighting. It is important that the occupants act as normally as possible so that their impressions can provide information on the success of the system.
2. To test the relationship between the theoretical calculations and the measured results.

## 4.2 MONITORING SYSTEM

The monitoring system consists of an NSC 800 micro-processor with built-in keyboard, display, and recorder. From this unit 17 sensors register the following parameters: 5 sensors for humidity levels, 9 for dry bulb temperature, and 3 for illuminance. These sensors are placed at significant points in the house.

All measurements were taken hourly for a period of one year.

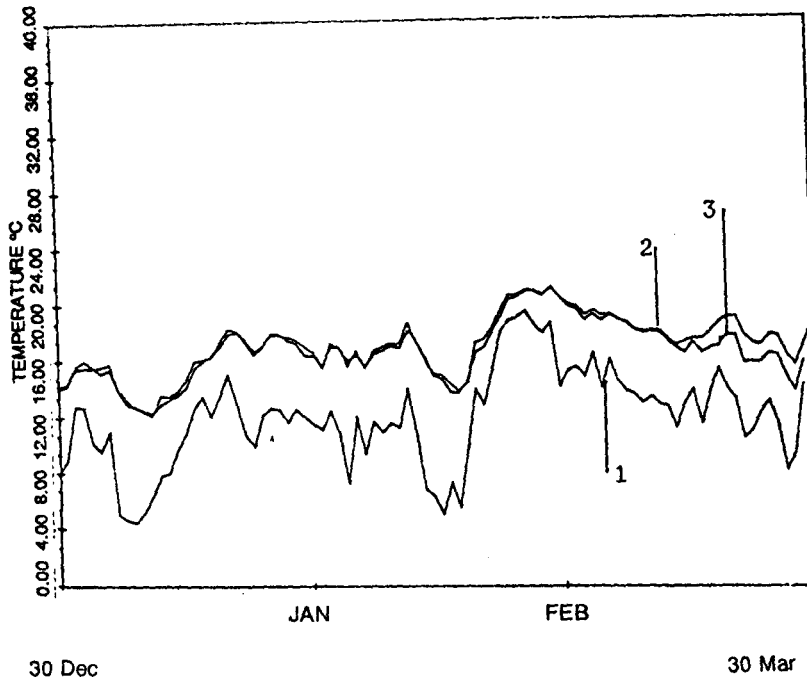

Winter  
Temperatures

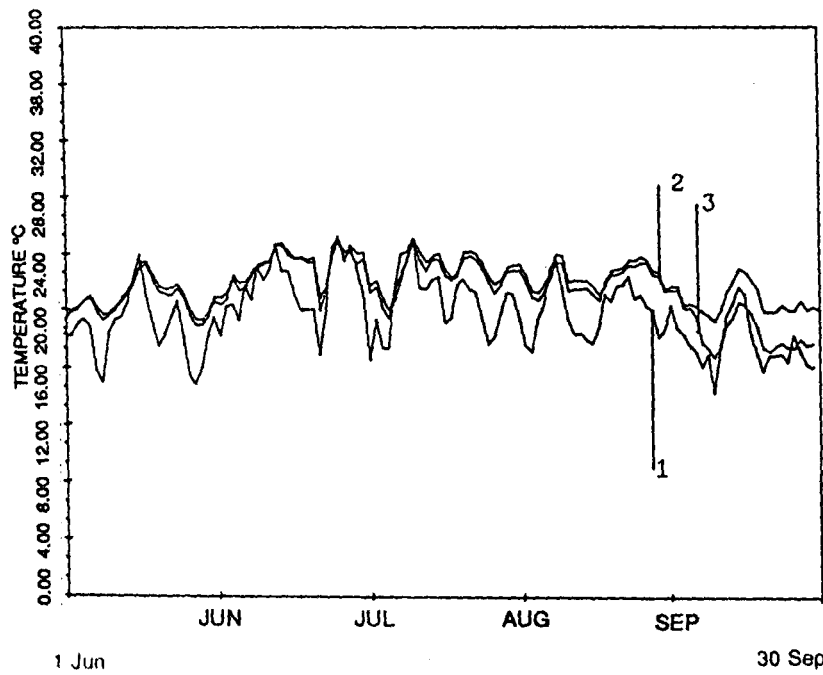

Summer  
Temperatures

- 1 - Average temperature: Outdoor
- 2 - Average temperature: Living room
- 3 - Average temperature: Stairs

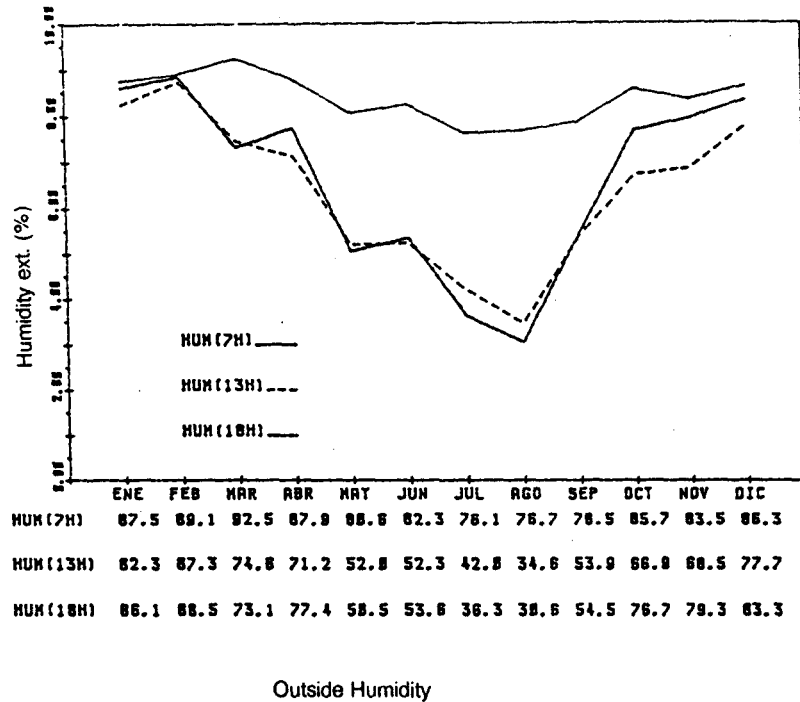
outside  
humidity

## 5.0 ECONOMICS

The building was designed and constructed at the same price as standard housing. Thus, the improved comfort and energy savings are achieved at the same cost as conventional housing. The hot water solar unit cost 120.000 Pts. (857 ECU) and will pay for itself in energy savings in 4 years.

## 6.0 CONCLUSION

The measured data have confirmed the theoretical calculations. The insulation levels and glazing area were appropriate for year round comfort and energy savings. The ventilaton losses were about 30%, approximately 1.3 air changes per hour.

The auxiliary heating demand was 1.92 W/m<sup>3</sup>. This means a passive systems contribution of about 70%. Daylighting covers the lighting demand throughout all daylight hours.



## 1.0 GENERAL

The "Suncourt" project consists of 71 balcony access apartments of which 50 surround a glazed atrium.

The building is located on a horizontal site in Hagsätra, a suburb south of the City of Stockholm. The energy design features are extreme insulation of walls and roof and heat pump operated cooling of the atrium used for seasonal heat storage in boreholes in the rock below the building.

Architect: VBB AB  
Box 5038  
S-102 41 STOCKHOLM

Energy: VBB AB

Consultants: Arlanda VVS  
Box 91  
S-195 01 MARSTA

Evaluation: Energy Conservation in Buildings Group  
(EHUB) Royal Institute of Technology  
S-100 44 STOCKHOLM

Contractor: JM Byggnads och Fastighets AB  
Box 27319  
S- 102 54 STOCKHOLM

Sponsor: The City of Stockholm and  
Swedish Council for Building  
Research St Göransgatan 66  
S-112 33 STOCKHOLM

Documentation of the Suncourt Project can be found in the following reports:

*Säsonglagring av passiv solvård i borrhil i berg för flerbostadshus* (\*Seasonal storage of passive heat gains in boreholes for multifamily housing', Lars Engström and Johnny Kellner, Swedish Council for Building Research R93:1983.

*Stockholmsprojektet. Effekt- och energisimuleringar med dataprogrammen BRIS och DEROB* (Energy simulations with the programs BRIS and DEROB") Engelbrekt Isfält and Hans Johnsson, Swedish Council for Building Research R59:1986.

*Stockholmsprojektet kv Höstvetet Överglasad gård, värmepumpar och borrhålslager i flerbostadshus - Suncourt* ("Glazed atrium, heat pumps and borehole storage in multifamily housing - the Suncourt system), Johnny Kellner, Swedish Council for Building Research R81:1986.

## 1.1 PROJECT DESCRIPTION

## 1.2 PARTICIPATING ORGANIZATIONS

## 1.3 PROJECT REPORTS

*Suncourt. Low Energy Multi-Family Housing*, Swedish Council for Building Research S7E:1986.

*Data Aquisition and Management Systems for the Stockholm project*, Bengt Wanggren and Peter Cleary, Proceedings from ACEEE Summer Study of Energy Efficiency in Buildings, Santa Cruz 1986.

*Indoor Climate Control, a Comparative Study of Six Different Solutions for Heating and Ventilation and the Possibilities of Individual Control*, Jagbeck, P.O., Eriksson, S.O and Werner, G. Proceedings from CIB conference "Healthy Buildings", Stockholm, 1988.

*Seasonal heat storage in borehole heat store in the rock beneath an apartment building in the Stockholm Project*, Göran Werner, Proceedings from JIGASTOCK-88, Versailles, France, 1988.

*Air heating systems in airtight multi family residential buildings*, Per Olof Jagbeck, Göran Werner, Karin Engvall, Proceedings from the 9th AIVC Conference, Gent, Belgium, 12-15 September, 1988.

Suncourt is one of six experimental apartment blocks within the "Stockholm Project", intended to support the development of guidelines for energy efficient housing.

2.0 CONTEXT

2.1 DESIGN OBJECTIVES

2.2 LOCATION

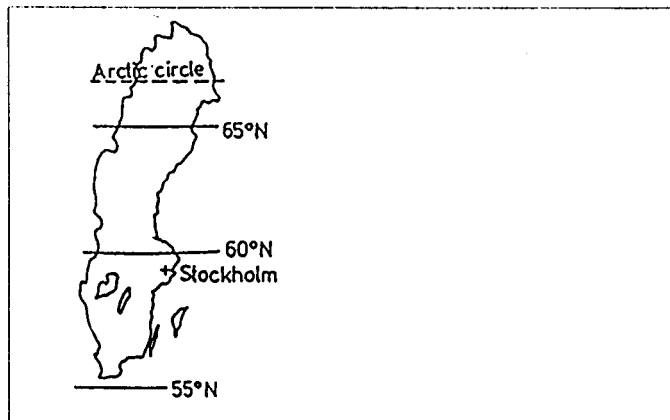

**Latitude: 59.27°N Longitude: 17.59°E Altitude: 30 Meters Above Sea Level.**

2.3 CLIMATE

The Stockholm climate is characterized by a fairly cold, cloudy heating season and a fairly warm and sunny summer season.

Average Annual Temperature.....+6.6°C	Degree Days (17°C Base)....3764 HDD
Average Winter Temperature.....+5.5°C	Global Irradiation.....3530 MJ/m²
Average Summer Temperature..+12.7°C	Diffuse Portion.....50%
Average Annual Relative Humidity....78%	Sunshine Hours.....1970

3.0 DESIGN

3.1 ARCHITECTURAL DESIGN

The apartment building is located on a flat unshaded site in a multi-family residential area 10 km south of the City. Vehicle access is from the west with occupant entrances from west and south. All parking is to the west. The layout is in six wings surrounding a glazed atrium and an open courtyard. Two wings are four stories; the others, three. With the exception of 18 apartments on the ground level, all are balcony access apartments. The most common type is two rooms and a kitchen. Seventeen apartments contain three rooms and kitchen and twelve four rooms and kitchen. There are common laundries on all



levels and storage rooms in the attic. The glazed atrium contains playgrounds and a winter garden.

All window areas are of standard size - approximately 15 % of the floor area. Outside windows are triple glazed with RSI-0.50. Windows facing the atrium are double glazed with RSI-0.33. Outside walls are insulated to RSI-5.88 and practically all thermal bridges have been eliminated through structural means. Atrium wall insulation level is RSI-3.33, roof RSI-8.33 and floor RSI-5.00. Atrium glazing is double with RSI-0.33.

Construction details are designed to provide extreme air tightness, and the glazed atrium adds to this by creating four insulated walls between windward and leeward In all directions. The atrium also serves as a common porch to all adjacent apartment entrances.

The thermal mass of the atrium consists of the brick paved courtyard, the access balconies and the brick veneer walls.

Designed ventilation rate is 0.5 air changes per hour. All apartments are individually heated and ventilated by heat exchangers and fans that provide a maximum of 5 recirculated air changes per hour. The heating supply of the ventilation air is combined with the domestic hot water circuit.

3.2 ENERGY DESIGN

INSULATION / INFILTRATION REDUCTION

THERMAL MASS

AIR CIRCULATION

DOMESTIC HOT WATER

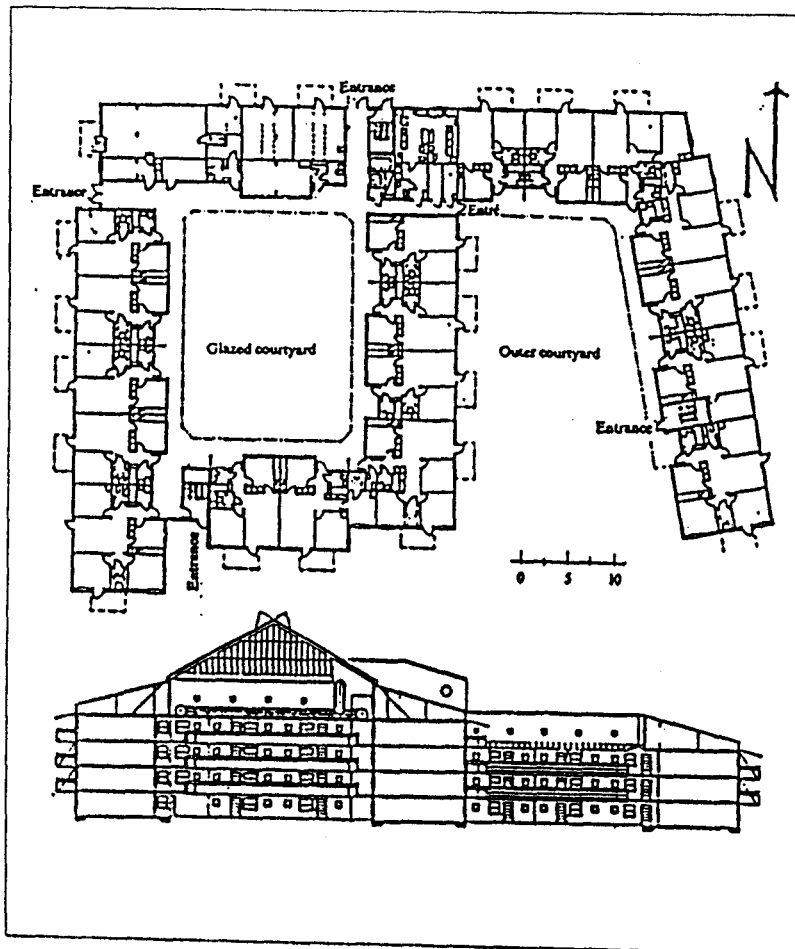

Floor Plan and Section

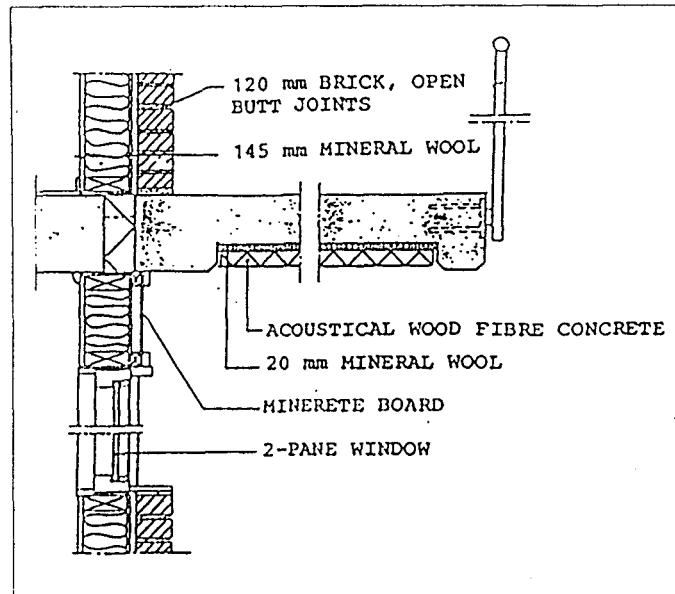

Vertical Section of Atrium Curtain Wall and Access Balcony

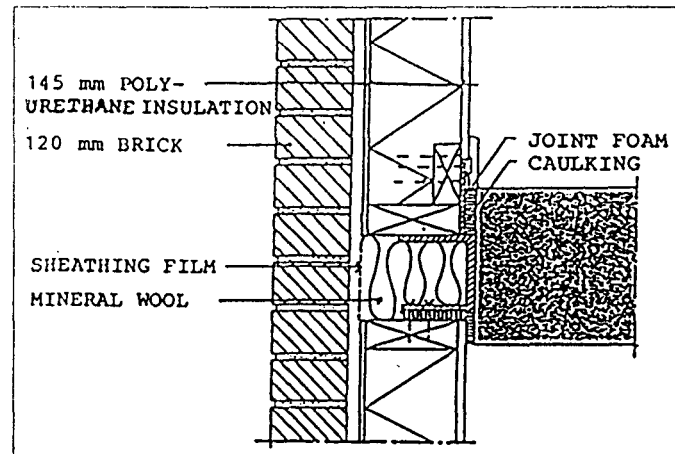

Vertical Section of Exterior Curtain Wall Passing Concrete Floor Slab

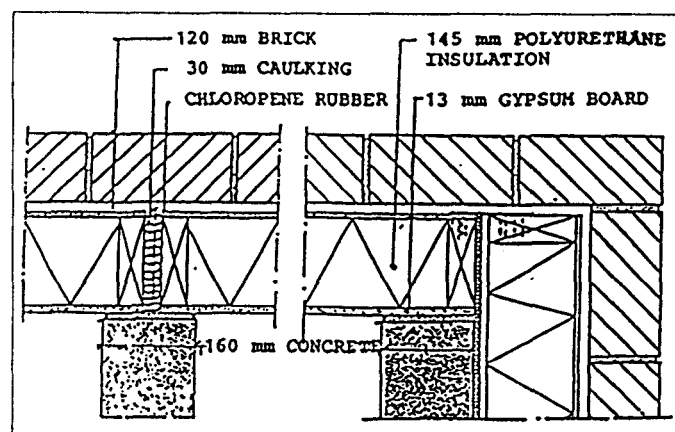

Horizontal Sections of Exterior Curtain Wall Meeting Structural Walls

The main experimental feature is the use of passive solar gains from the atrium. As soon as the atrium temperature exceeds 20°C at living levels, the atrium ventilation system activates an air to water heat exchanger coupled to two heat pumps. The heat pumps primarily supply the hot water storage tanks and when these are fully charged, the surplus heat is stored in 26 000 M<sup>3</sup> of rock penetrated by 25 holes bored in 'broom shape' 80 meters deep, spaced 4 meters apart. When the cooling power of the heat pumps is insufficient, the atrium is automatically cross ventilated through fire protection ventilators in the roof. At atrium temperature levels below 20°C, the heat pumps operate with outdoor air down to +6°C. The borehole storage is designed to swing between +2 and +15°C on an annual basis, being loaded in summer and unloaded - also by the heat pumps - during the heating season. The design temperature of the combined heating and hot tap water system is 50°C. The COP of the heat pumps when unloading the storage could then be based upon an average evaporation temperature of some 9°C and a condensation temperature of about 50°C.

During the design phase extensive analysis of the Suncourt project was performed by VBB using the DEROB main frame computer program. Energy balance and temperature swings of the apartments and atrium were simulated. The results were used for tuning ventilation rates, insulation levels and window areas. The thermal performance of the borehole storage was simulated by VBB using a programme developed at the Technical University of Lund. The interaction between building and storage by heat pump operation was calculated through input-output procedures between the programs. The predicted requirement of the apartments for purchased energy for space heating and domestic hot water was about 145 MJ/m<sup>2</sup> per year. Today's newly built apartment blocks - following a very stringent building code - normally require about 290-325 MJ/m<sup>2</sup> per year.

#### 4.0 ANALYSIS

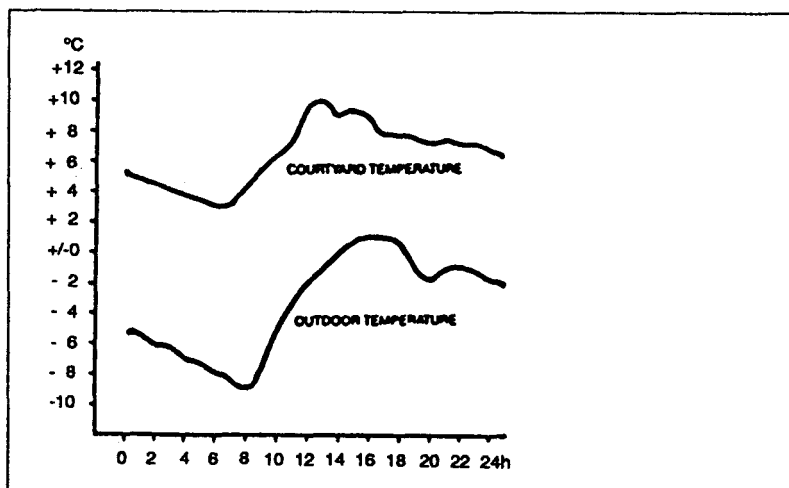

Example of atrium temperature swings on a normal winter day

Performance (theoretically simulated by computer program DEROB)

<b>Winter:</b>	Electrical power:	118 MWh ( 425 GJ)
	Heating and hot tap water:	295 MWh (1065 GJ)
	From seasonal storage:	177 MWh ( 640 GJ)
<b>Summer:</b>	Electrical power:	79 MWh ( 285 GJ)
	Loading seasonal storage:	177 MWh ( 640 GJ)
	Ambient air:	73 MWh ( 265 GJ)
	Atrium air:	110 MWh ( 395 GJ)
	Hot tap water:	85 MWh ( 305 GJ)

DEROB-VBB. ENERGY BALANCE

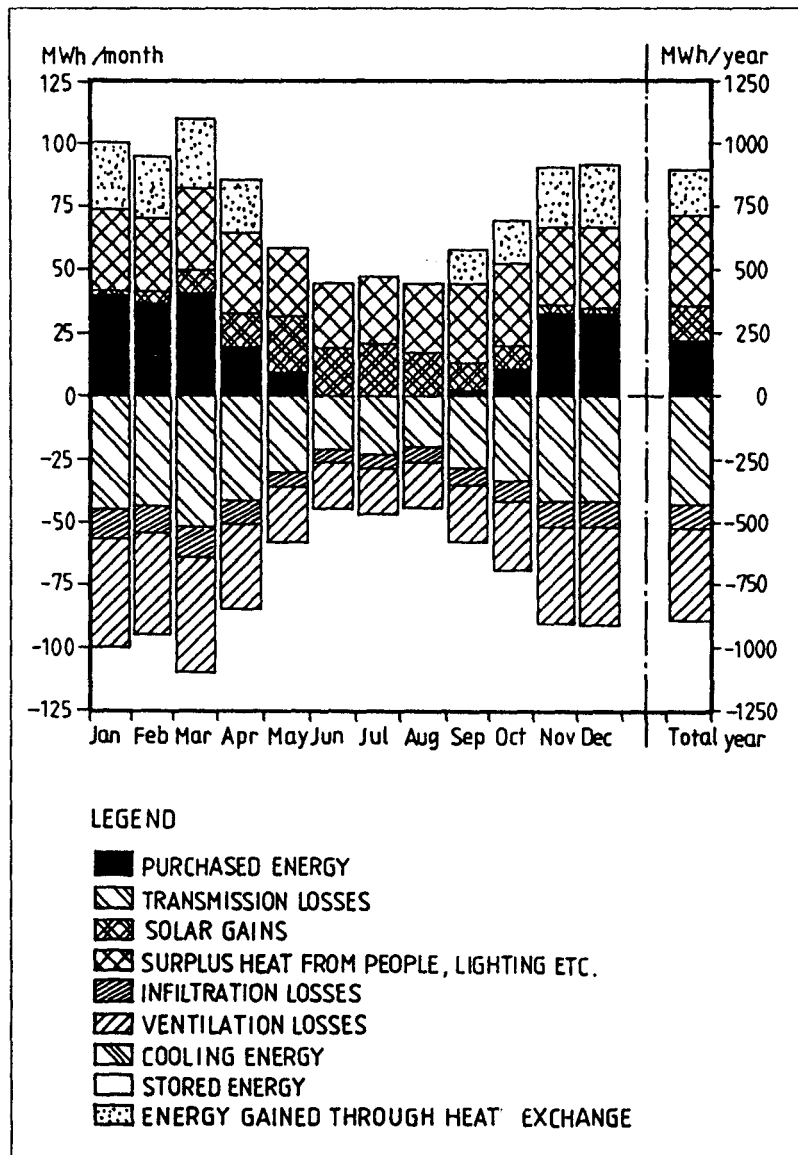

The monitoring objectives for the Suncourt project were to:

- Assess the reduction in building heating load compared to conventional apartment blocks.
- Assess the year round comfort in apartments and atrium.
- Assess the complex functions of the thermal and ventilation systems.
- Assess the thermal performance of the borehole storage system.

The data acquisition equipment consists of an HP86 microcomputer, 240 sensors and an auto-answer telephone modem. Channels are polled every 5 or 15 minutes by the computer, depending on the total number of sensor channels connected, and channel totals are stored in memory on an hourly basis using a central computer. The hourly files are retrieved and stored on diskettes for analysis and plotting.

**Measurements made include:**

<b>Climatic parameters:</b>	Solar radiation, temperature and wind speed.
<b>Energy Consumption Parameters:</b>	Total and detailed electric power, temperatures and flows in airducts, piping, heat exchangers etc.
<b>Interior Temperatures Parameters:</b>	Space temperatures of 23 representative apartments of which 6 are in the "free" reference wing. Supply and exhaust air temperatures centrally measured in the fan room.

The system is very complex and the adjustment of components and regulation valves etc. needed almost two years. Main problems were encountered in the heat pump system.

Reliable measurements started being collected in August 1988, and thus no representative results for a whole year will be available until the fall of 1989. Some interesting results may be quoted however.

The DEROB simulations were based on a heat pump cooling power of 50 kW. Calculations based upon measurements in July 1986 indicate only 35 kW, but it must be remembered that the heat pump system at that time was not fully adjusted. Even so, the combined effect of heat pump cooling and cross ventilation was a maximum temperature of 26 °C at balcony level on several extremely hot and sunny days.

In the case of the borehole storage, measurements from the summer of 1986 show a loading pattern as predicted through simulations, whereas the unloading process so far has not been studied, due to the heat pump regulation problems.

## 5.0 MONITORING

### 5.1 MONITORING OBJECTIVES

### 5.2 MONITORING SYSTEM

### 5.3 PERFORMANCE RESULTS

A general observation in all six Stockholm projects is that the electricity demand for elevators, pumps, fans, etc. is much bigger than assumed. Even in conventional apartment building, it is equal to domestic electric use, which is in the range of about 25-30 kWh/m<sup>2</sup>/year.

#### **5.4 OCCUPANT EVALUATION**

All Stockholm projects are being extensively evaluated from sociological points of view. In the Suncourt project much attention has been paid to the amenity of the glazed atrium. The occupants in general seem to appreciate the atrium as a common porch, but it is not much used. One reason for this is that most adults work and the children spend the weekdays in nursery homes or at school. On holidays many families go away to weekend houses.

The airborne heating system seems to satisfy most tenants, but some complaints on space temperature during extremely cold periods have been noted. Again, it must be pointed out that the tuning of the heating and ventilation systems was not completed until recently.

#### **6.0 ECONOMICS**

##### **6.1 ADDITIONAL CONSTRUCTION COSTS**

The glazing of the atrium costs about \$ 1 000 per m<sup>2</sup>. On the other hand, all facades facing the atrium can be simplified. Above all the number of staircases and elevators decreases as compared to traditional balcony access apartment buildings. Altogether the total cost of the building was equal to ordinary apartment housing and well qualified to state loans.

The heat pump system and the borehole storage of course add to the project cost, and they were paid by experimental loans administered by the Swedish Council for Building Research.

##### **6.2 COST EFFECTIVENESS**

As no reliable energy balance evaluation is so far available, the cost effectiveness of the system cannot yet be calculated. It should be pointed out, however, that the seasonal storage system is far from optimized. For reasonable economics, it should be at least five times bigger, a size suitable for some 350 apartments in several blocks grouped around one common storage system, for instance below a parking lot. The Suncourt project is an experiment, not a definite solution.

#### **7.0 CONCLUSION**

The project demonstrates that the architectural, construction and comfort problems of an energy efficient apartment block comprising a glazed atrium can be solved. It also demonstrates that adjustments of heating and ventilation systems require more time than is generally supposed. Even the fairly traditional systems in other Stockholm projects have shown this to be an important issue.

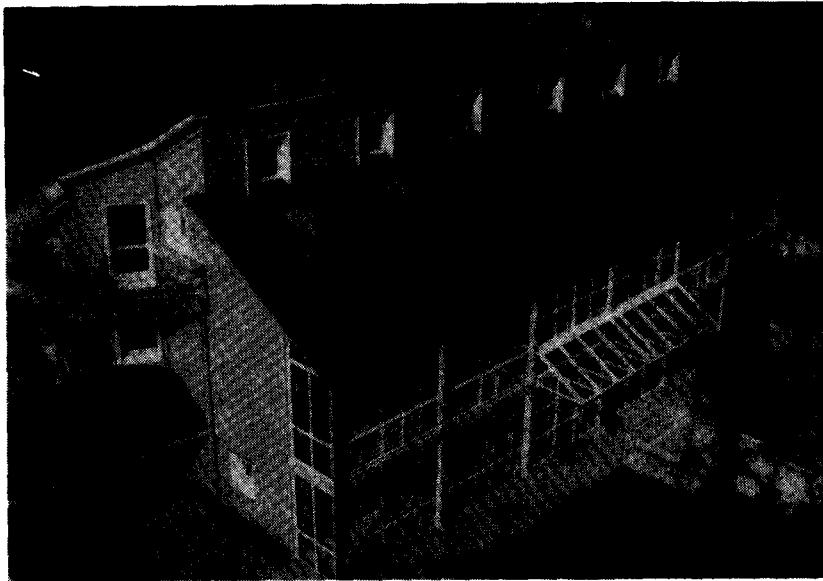

The building (built in 1985/86) is situated on a steep south-westerly sloping hillside. The north wall is completely underground and the north side of the roof is also earth covered. The building is of typical concrete masonry construction with high levels of insulation. The south facade has large glazing areas almost entirely protected by an expansive two story attached sunspace. The sunspace buffers heat loss from the large south glazing area, provides an enlarged unheated living space and delivers direct sunlight and warmed air to the living area. Heat can also be distributed by fan from the sunspace to the partly heated north zone.

1.0 GENERAL

1.1 PROJECT DESCRIPTION

1.2 PARTICIPATING ORGANIZATIONS

1.3 PROJECT REPORTS

<b>Architect:</b>	<b>P. &amp; B. Weber</b> Stigweldstr. 21 CH-8636 Wald
<b>Project leader IEA VIII/D:</b>	<b>ARENA, A. Binz</b> Dreikoenigstr. 49 CH-8002 Zuerich
<b>Computer simulation:</b>	<b>EMPA - KWH</b> A. Guetermann CH-8600 Duebendorf
<b>Monitoring:</b>	<b>EGGENBERGER BAUPHYSIK</b> A. Eggenberger CH-3400 Burgdorf
	Several consulting experts

Documentation of the Wald project house can be found in the following reports:

Die Optimierung der passiven und hybriden Sonnenenergienutzung an drei Projekten  
A. Binz and A. Guetermann, Feb. 1986  
available from: INFOSOLAR, Postfach, CH-5200 Brugg

Thermische Messungen in einem erdgeschützten Wohnhaus mit verglasten Veranden  
A. Eggenberger  
available spring 1989 from: INFOSOLAR, Postfach, CH-5200 Brugg

## 2.0 CONTEXT

The project is intended to show that property, which is normally not very attractive to build on, can be used for a low energy earth sheltered design. The complex consists of two similar 2 1/2 story and basement row houses.

## 2.1 DESIGN OBJECTIVES

The objective was to design a reasonably priced house with a certain amount of individual arrangement and with regard to the use of renewable energy sources. This was done by reducing heat losses by burying the house in a hillside on the north side, and providing a glazed veranda on the south side. On days with strong sun the veranda should also deliver heat to the north rooms, which are only partly heated (zoning). The units should provide living/dining room, kitchen, three bedrooms, bathroom, separate toilet, access area, attic/guestroom with separate bathroom and full basement.

## 2.2 LOCATION

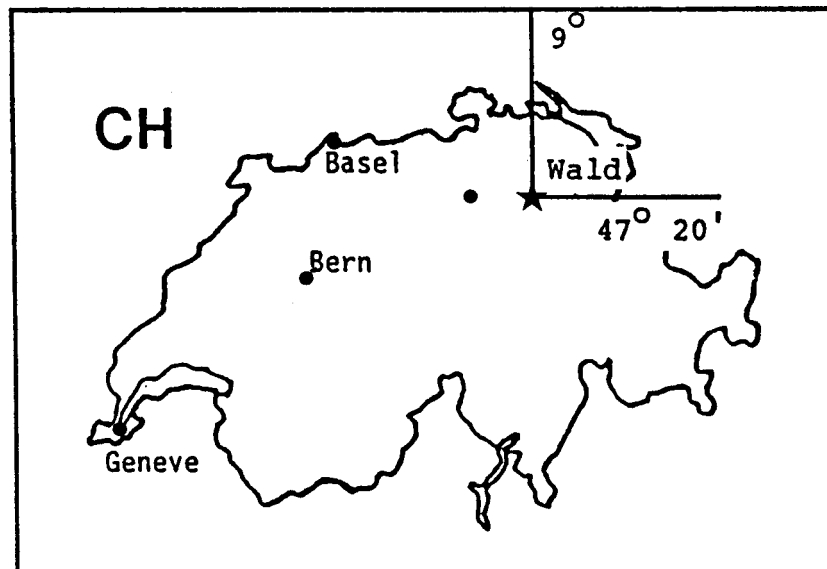

Location : CH-8636 Wald, 620 m elevation

## 2.3 CLIMATE

The climate is characterized by a long, cloudy, partly foggy heating season. Often this location remains just above the fog level and so takes advantage of the higher insolation. The summer period is short, mild and dry. Long term climatic data for the region are shown below.

<b>Average Annual Temperature</b>	<b>6.5 °C</b>
<b>Average Winter Temperature</b>	<b>0.5 °C</b>
<b>Average Summer Temperature</b>	<b>12.5 °C</b>
<b>Degree Days (20/12 °C base, monitoring period)</b>	<b>4100 HDD</b>
<b>Global Insolation (vertical SSW, monitoring period)</b>	<b>790 kWh/m<sup>2</sup></b>



Since the building is buried half way into a very steep lightly wooded southfacing hillside, excellent protection from cold winter winds is provided. All access is from the south up a steep staircase or through the underground garage and basement. The units are individually arranged inside.

**3.0 DESIGN**

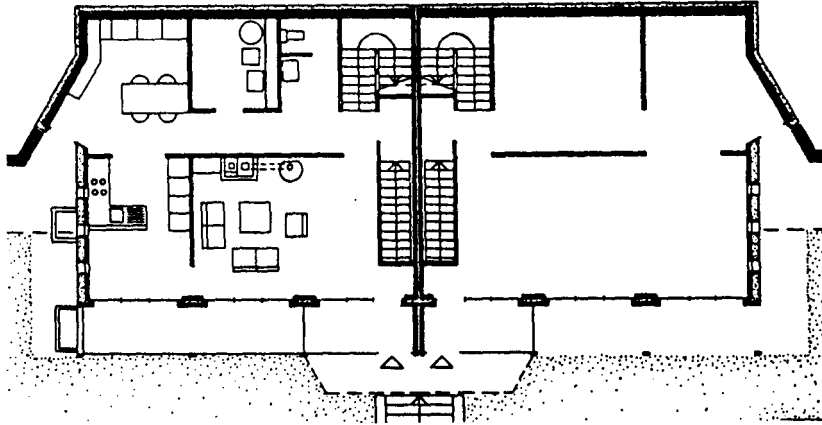

Ground Floor Plan

The unit studied has a living room and kitchen on the south side of the ground floor. On the north side are the storage area (or otherwise flexible use space), equipment room and toilet. The first (upper) floor has two bedrooms and one office on the south side, a bathroom and a variable-use space on the north side. The attic space can be used as an additional large bedroom/guestroom with its own bath, or can be rented as a separate flat with separate access from the west.

**3.1 ARCHITECTURAL DESIGN**

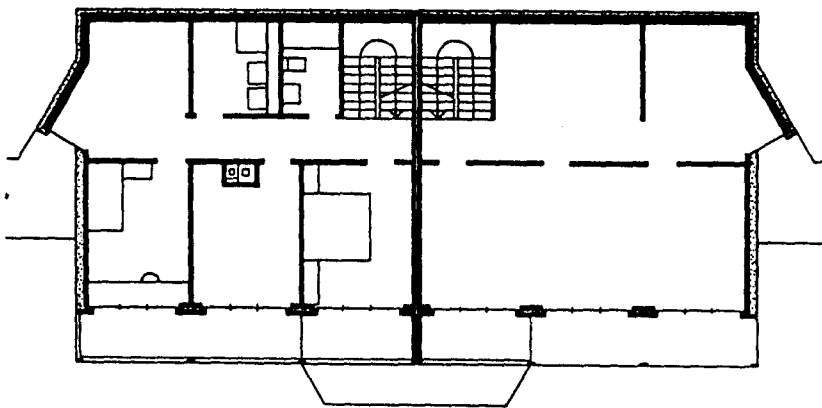

1st Floor Plan

**3.2 ENERGY DESIGN****ENVELOPE INSULATION****THERMAL MASS**

The row houses are constructed in traditional style. The opaque building envelope U-values are 0.2 - 0.35 W/m<sup>2</sup>K. The north wall and the north facing roof are constructed from reinforced concrete to support the earth loads. Waterproofing is achieved using conventional flat roof details (e.g. copper flashing, seamed water barriers). 12 cm of polystyrene is used as insulation. To provide sufficient mass, internal and external walls are built of lime sand masonry units which are locally available (environmental protection was considered). External walls are insulated with 20 cm of glass wool. Weather shielding is provided by wooden clapboard. The basement ceiling and the opaque supporting structure on the south side has 10 cm of insulation. The overall building heat loss coefficient is 0.2 W/m<sup>2</sup>K, including veranda and earthcover.

**FORM CONCEPT**

The principal form concept evolved from:

- earth shelter to the north
- temperature zoning
- all windows to the south and buffered by a sunspace

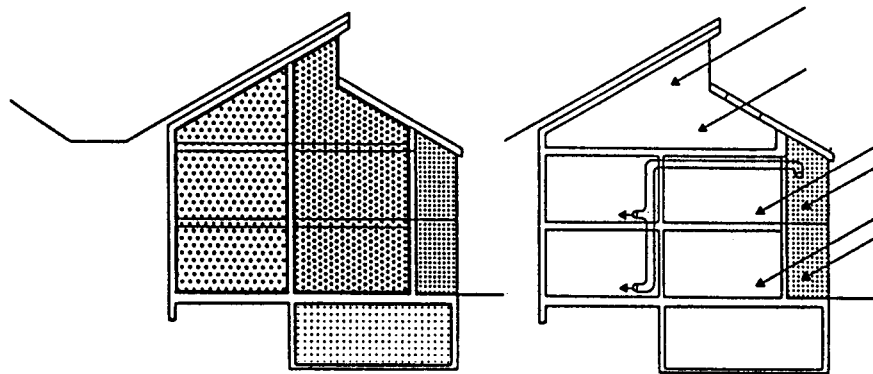

Zoning and solar collection

**SOLAR COLLECTION ZONE**

The house is divided into a fully heated core zone which is buffered all around by floating temperature zones: the unheated basement; the semi- or temporarily heated spaces of the north zone (stairs, storage, toilet and bathrooms); and the two-story glazed veranda which provides an extension of the living space on sunny winter days. Its warm temperature reduces heat losses through the large window areas of the south rooms. Excess heat can be delivered via ducts to the north rooms.

**GLAZING**

There is no glazing to the north and only minimal glazing (triple pane) to the west (or east) primarily for ventilation. 90% of all glazing faces south. In the attic there is triple glazing. Double glazing with wooden frames is provided in the direction of the glazed veranda. The glazing of the veranda itself is also double. For the sunspace construction an alternative to uninsulated metal framing was sought, but dismissed for architectural and practical reasons. The sunspace glazing must be completely openable in the summer. Neither metal construction with a thermal break nor wooden construction proved affordable.

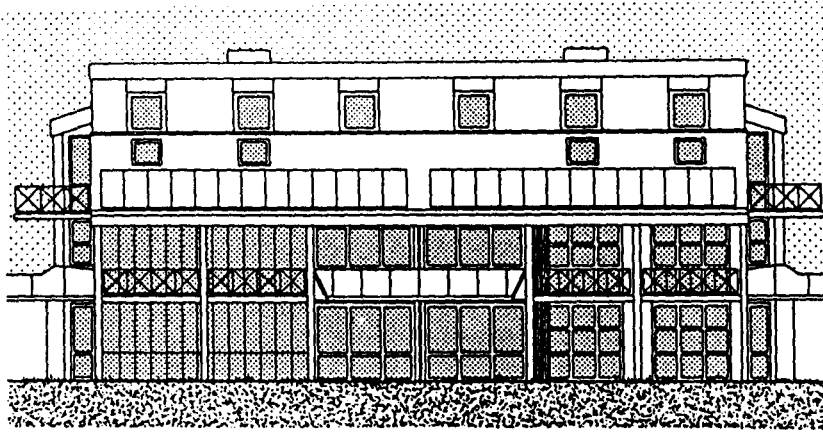

South Elevation

The only auxiliary heating is provided by wood burned in a recirculating fireplace in the living room. The heat is not distributed in the house in a separate air ductwork system and so primarily heats only the living room.

#### AUXILIARY HEATING SYSTEM

Analysis was performed using the program DEROB. Several parametric studies suggested a more optimal energy design, especially of the sunspace (glazed veranda).

#### 4.0 ANALYSIS

A base case consisted of double glazed south-facing windows for the house and single glazing with an uninsulated aluminium frame for the sunspace. Out of several variations, the relatively airtight sunspace with insulated frame and double glazing was the most energy conserving (25 % house heating load) and the sunspace average temperature was 3.5°C warmer than the base case.

#### 4.1 GLAZING AND FRAME QUALITY

An interesting result of having either good (2cm), airtight night insulation or an additional layer of glass is that both provide similar auxiliary heating savings. Considering the unlikelihood of night insulation being used as optimally as in the simulation, additional glazing is superior.

#### NIGHT INSULATION

The double glazed/good frame quality sunspace roof was replaced with a normal opaque insulated roof. This slightly increased auxiliary heating due to shadowing but raised the mean sunspace temperature and no more hours below freezing occurred. Further, there was less overheating in spring.

#### SLOPED GLAZING

Forced ventilation of the sunspace-heated air to the north zone reduces house auxiliary heating (in this case about 3%), but ventilating power that can handle 10 air changes per hour is necessary. Less overheating of the sunspace is an additional benefit.

#### VENTILATION

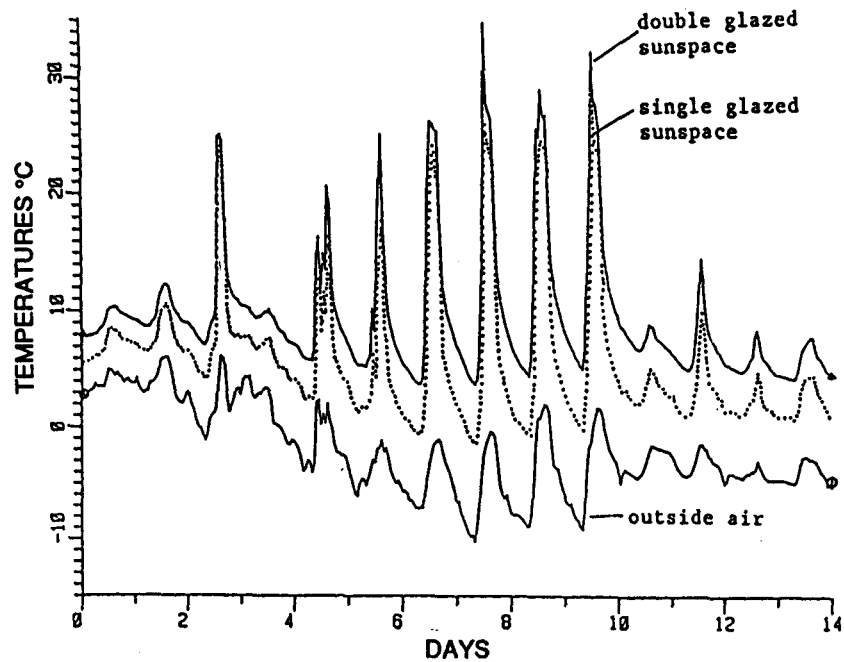

FIGURE 1: Simulated air temperatures of two sunspace configurations

#### 4.2 COMPARISON TO DIRECT GAIN

The house, without a sunspace, but with triple glazed south windows was also simulated. This variation with night insulation had comparable performance to the sunspace variation (sunspace double glazed, house windows double glazed).

### 5.0 MONITORING

#### 5.1 MONITORING OBJECTIVES

The monitoring objectives for the Wald project were:

- to assess the consequences of the energy and heating concept concerning the energy used and the comfort produced;
- to establish the contribution due to the glazed veranda, to the zoning and to the earthcovering; and
- to establish how well the overall planning goals were met.

#### 5.2 MONITORING SYSTEM

The data acquisition equipment consisted of a HP 3497A programmable data logger with 60 analog and 16 pulse counting channels, together with a small HP 85 computer. Thermocouples were used for temperature measurement. Channels were scanned every minute, the necessary values integrated and all data stored on an hourly base on a tape cartridge, which was changed on site every 2 to 3 weeks. The data were viewed and analysed on a HP 310. Measurements made include:

<b>Climatic parameters:</b>	Global horizontal and global veranda surface (vertical SSW) solar radiation, dry bulb temperature, wind speed and direction.
<b>Interior temperature parameters:</b>	Dry bulb temperatures in 16 rooms, window and shutter status in living room and on 1st floor, comfort meter in living room.
<b>Sunspace:</b>	Dry bulb temperature and comfort meter on ground- and 1st floor, floor temperature and relative humidity 2nd floor.
<b>Solar air circuit:</b>	Inlet and outlet dry bulb temperatures , air flow rates.
<b>Earth cover:</b>	North wall and rock temperature behind 1st and 2nd floor up to 5m deep (6 steps).
<b>Auxiliary heating:</b>	Surface temperature of woodstove.
<b>Consumption:</b>	Manual readings of the electricity meter and yearly overall wood consumption.

The total energy consumption of the building during the monitoring period was:

- Wood:	3 m <sup>3</sup>	=	5'550 kWh
- Electric energy total:			6'882 kWh
(aprox. 20% DHW, 20% heating, 60% general use)			

**5.3 PERFORMANCE RESULTS**

The total electric energy consumption was hand recorded on a monthly basis. On the average it is 20% higher in winter (heating) than in summer. The wood burned could only be "measured" as an overall yearly figure. To give an indication of the monthly use of the woodstove the difference between its surface temperature and the living room air temperature was integrated over the time period during which the difference occurred. This resulted in a figure similar to heating degree days. Together with the overall wood consumption, the monthly amount of wood burned in kWh can be found and is shown on the next page.

**CONSUMPTION**

Figure 2 shows the monthly average indoor temperatures for the heated living room and an average of all other (unheated) rooms, which all had very similar temperatures. Further, average ambient air and sunspace temperatures (for the month the veranda glazing was completely in place) are plotted. Global vertical Insolation and wood burned in kWh are shown for the respective month.

**TEMPERATURES**

The curve shows that the building (with the exception of the living room) did not meet the normal thermal comfort conditions during the heating period. During the months December through March, interior temperatures were too cold. Further investigation into this problem, showed that the low indoor temperatures are mainly due to the way the building is heated. A simple woodstove in the living room without forced ventilation was not sufficient to heat ail of the core zone. This is the case even in a very carefully designed and optimised passive solar home in cold and sunless winters. The result: overheating in the living room (see also figure 3) and underheating of all other rooms. Detailed studies showed that it would be possible to heat almost all of the rooms to comfortable temperatures with the same amount of energy if an appropriate heating system was used.

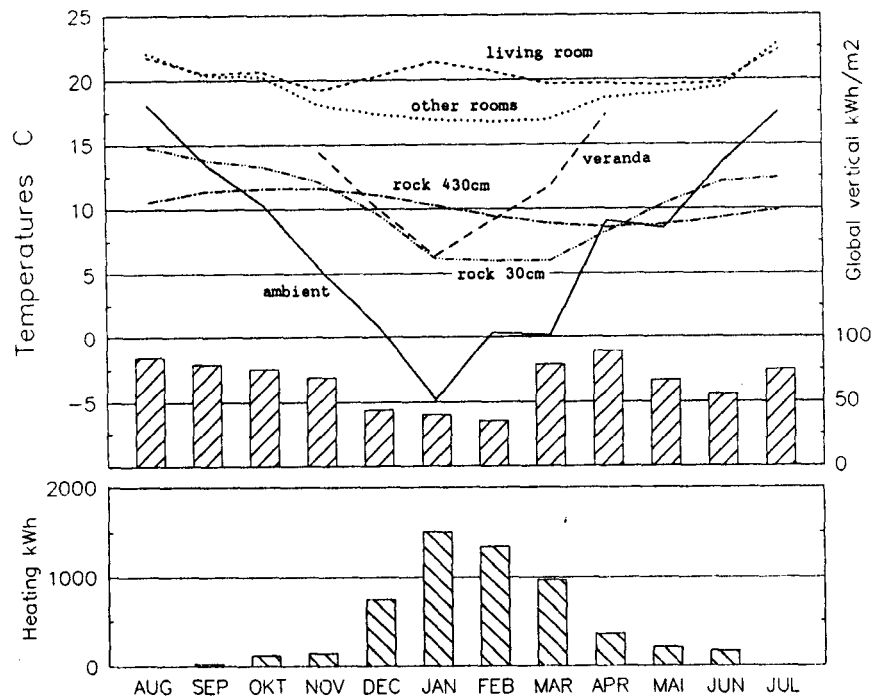
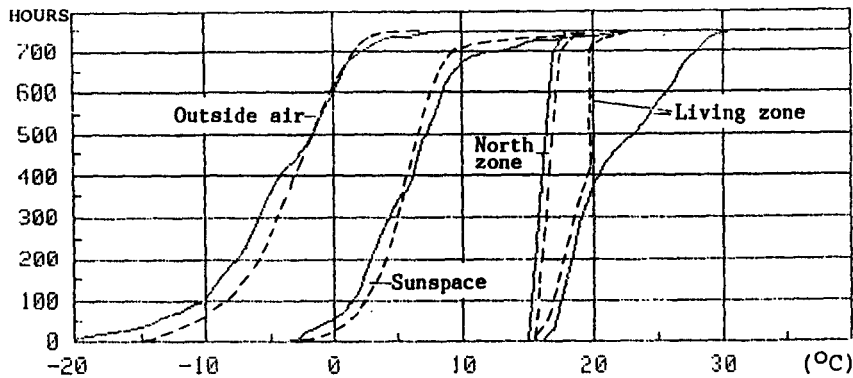

FIGURE 2: Monthly average temperatures, Insolation and wood burned

#### VERANDA-SUNSPACE

The glazed veranda performance worked out just as predicted by the simulations. Figure 3 shows a comparison. The drift of the measured living room temperature above 20 °C is due to the nonoptimal use of the woodstove as mentioned above. The glazed veranda just about halves the temperature difference that would otherwise occur on that facade, and so it is an average of 10 °C warmer there than outside. Comfort analysis showed that during the daytime, with only 200 W/m of solar radiation, comfort can be achieved above 0 °C outside air temperature. Analysis based on the measurements confirmed the result found by the simulation that the energy saving due to the glazing of the veranda is over 30 %. The glazing of the veranda is, all the same, not optimal. The gap between the double glazing (6mm) should be increased, the shadowing due to framing and its heat transfer reduced. Very little overheating occurs because there is no tilted glazing used for that sunspace and the south glazing can be folded away completely during summer. Because the fan capacity installed was much too low (only 1/5 of the figure found by simulations) it had almost no effect on the energy flow to the north zone.



**FIGURE 3:** Frequency distribution of measured and simulated (dashed lines) temperatures in January

One goal of this project was to find out about the temperatures in the rock on the north side of the building and how this influences the energy balance of the house. Figure 2 shows rock temperatures 5 m below the surface at different distances from the north wall. One would expect the temperatures to increase a little towards the building wall; the contrary is the case! Due to water (rain, melting snow) which finds its way down along the wall to the drainage pipe which is at the bottom of the north wall, both the north wall and the rock is cooled down and so the rock temperatures there are much closer to outside air temperature than to room temperature. In this case the same effect on the energy use would have been possible by adding only 1 cm of insulation to the wall. Does that mean earth covering does not work well? In this case yes, but it would do a much better job if the drainage water were collected at the top of the north wall and channelled away.

The occupants are satisfied with the house in general, and also with the thermal comfort in it (they have adapted). They said that in the first year of occupancy (during the measurements) they had to burn more wood than the following three years mainly because the building began to dry out. If they could build the house again they would make the veranda deeper (2 m instead of 1.5 m) and very likely would make the first (upper) floor the living area because of the natural temperature build up.

The selling price of the unit was sFr. 650,000.-, which is about average for this standard of design and construction. The higher cost of excavation, extensive reinforced concrete construction and earth covering was compensated by the very low land price of the "normally not able to build on" property.

#### EARTH COVER

#### 5.4 OCCUPANT EVALUATION

#### 6.0 ECONOMICS

**6.1 ADDITIONAL COSTS**

The total construction cost includes the costs for the higher than usual insulation, about sFr. 10'000.-, and the veranda glazing, about sFr. 50'000.-. On the other hand, savings of about sFr. 10'000.- resulted from installing only a woodstove instead of a centralized heating system.

**6.2 COST EFFECTIVENESS**

It is impossible to speak about cost effectiveness especially if oil prices are so low. But in general sunspaces are not only built to save energy. They add additional living space and increase comfort; things which are not so easy to account for in terms of money. Heating the whole unit by a single woodstove in the living room was unsuccessful. Heat distribution has to be improved.

**7.0 CONCLUSIONS**

The project showed that it is possible to build an energy efficient, passive solar house on a difficult site. Three improvements should be made to the current design:

- 1) The ventilation of air from the sunspace to the north zone and back is insufficient. It might be better to provide natural convection using automatic door openers when nobody is at home.
- 2) A heating system which distributes heat more evenly and effectively must be included.
- 3) Earth covering has to be kept dry to achieve desired effect.

On a more theoretical level, it has been shown that a computer model is able to predict the thermal behavior of a sun oriented building design.





1.0 GENERAL

The project consists of a 2 1/2 story single family row house located on a slightly sloping site in Schuepfen, near Berne (Switzerland). The energy design features are direct gain through windows and solar air heating panels integral with the south facade. Direct gain heat is stored in the exposed masonry walls and partitions; collector provided heat is stored in latent storage contained in a wall in the middle of the house. Sunspaces were also investigated and have been built on several houses in the complex.

1.1 PROJECT DESCRIPTION

**Architect:** AARPLAN, M. Leibundgut  
Tellstr. 18, CH-3014 Bern

**Project leader  
IEA VII/D:** ARENA, A. Binz  
Dreikoenigstr. 49  
CH-8002 Zuerich

**Computer simulation:** EMPA - KWH  
A. Guetermann  
CH-8600 Duebendorf

**Monitoring:** EMPA - erg  
G. Zweifel  
CH-8600 Duebendorf

Several consulting experts

1.2 PARTICIPATING ORGANIZATIONS

Documentation of the Schuepfen project house can be found in the following reports:

1.3 PROJECT REPORTS

Die Optimierung der passiven und hybriden Sonnenenergienutzung an drei Projekten  
A. Binz und A. Guetermann, Feb. 1986  
available from: INFOSOLAR, Postfach, CH-5200 Brugg

Messprojekt Schuepfen, Schlussbericht  
G. Zweifel, EMPA, Abt. Bauphysik  
available spring 1989

The building studied is part of a complex of 36 similar row houses. Each row has 4 to 5 units, each with 2 1/2 stories plus basement. The complex was built by a cooperative, consisting of the house owners (=occupants).

2.0 CONTEXT

### 2.1 DESIGN OBJECTIVES

The objective was to design reasonably priced houses in a common style with a certain amount of individual arrangement and with regard to the use of renewable energy sources. The program of the studied 183 m<sup>2</sup> middle unit is typical for a Swiss low cost row house: living/dining room, kitchen, three bedrooms, bathroom, separate toilet, access area and full basement.

### 2.2 LOCATION

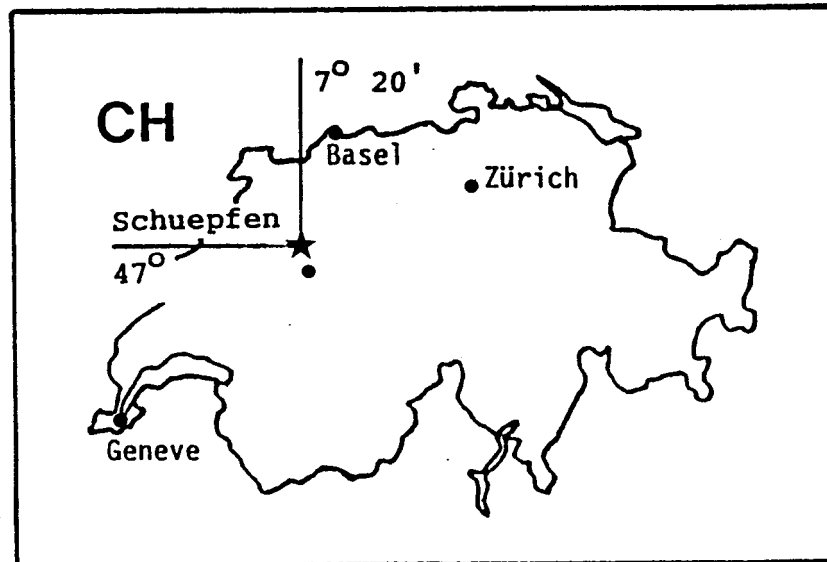

### 2.3 CLIMATE

The climate is characterized by a long cloudy and foggy heating season and a short mild and dry summer period. Long term climatic data for the region are shown below.

Average Annual Temperature	8.6 °C
Average Winter Temperature	5.8 °C
Average Summer Temperature	17.0 °C
Degree Days (18 °C base, monitoring period)	3392 HDD
Global Irradiation	4200 MJ/m <sup>2</sup>
Diffuse Portion	53 %

### 3.0 DESIGN

The whole complex is situated on a gentle south slope. All rows are oriented to the south. The access is from the north side of the rows, and the access areas are separated by continued parts of the north roof, providing a private area, storage space (e.g. for wood) and wind protection at the same time. The units are individually arranged inside.

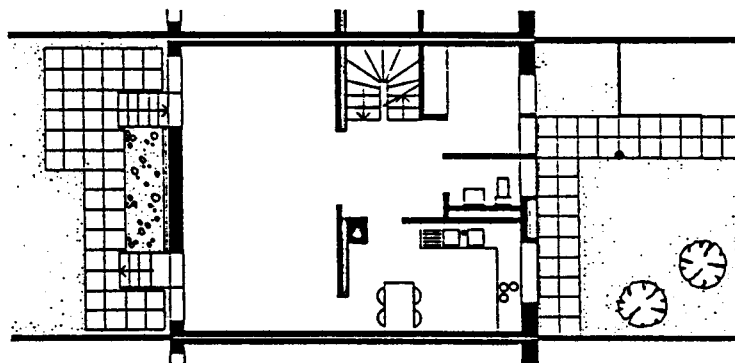

Ground Floor Plan

The unit studied has a living room on the south side of the ground floor. On the north side are entry, kitchen and toilet. The 1st floor has two bedrooms on the south side, one bedroom, bathroom and a small variable-use space (at present photolab) on the north side. The attic space is partially used as a gallery for the north bedroom.

**3.1 ARCHITECTURAL DESIGN**

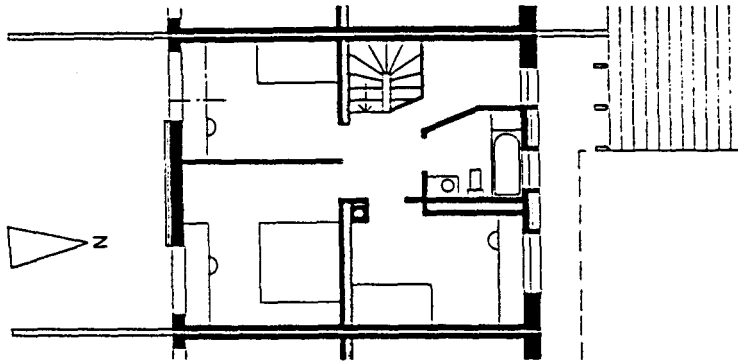

1st Floor Plan

The row houses are constructed in traditional style. Walls are cavity-wall masonry construction with a U-value of 0.3 W/m<sup>2</sup>K. The U-value of the wood-frame roof is 0.25 W/m<sup>2</sup>K. The width of the units is relatively large for row houses, providing a big south facade. This is also reached by the slight south slope with the entrance on the north side at ground level, getting half of the basement free on the south side. All the living area is situated to the south while northern rooms are only partly heated (bedrooms etc.).

**3.2 ENERGY DESIGN**

**ENVELOPE INSULATION**

**FORM CONCEPT**

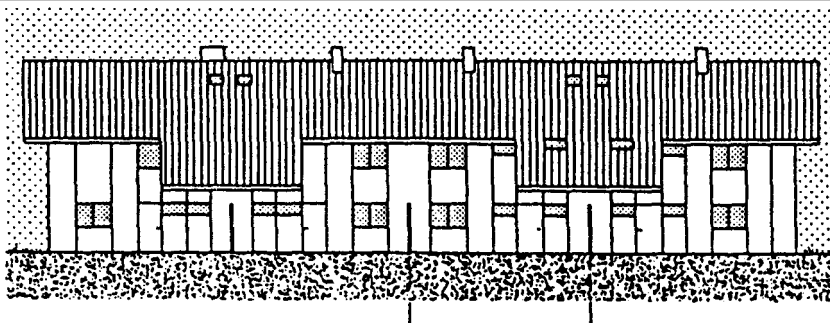

North Elevation

There is minimal glazing on the north facade for light and ventilation. South glazing is dimensioned according to the optimization study during the design phase, evaluating window area against air collector area. All glazing is triple glass without coating, with a U-value of 2.0 W/m<sup>2</sup>K. Movable IR-reflective coated layers provide night insulation and solar protection at the same time.

**GLAZING**

The 13.9 m<sup>2</sup> of south glazing provide direct solar gain for the south facing rooms. The energy is stored in the exposed masonry walls and partitions and in the concrete ceilings. The floors are covered with dark slate slabs, providing good absorption of the penetrating radiation and good heat conduction.

**SOLAR GAINS  
DIRECT GAIN**



South Elevation

**AIR COLLECTOR SYSTEM**

Solar energy for the north rooms is provided by a 15.1 m<sup>2</sup> (net area) air collector integrated in the south facade. It consists of a wood frame with a dark blue perforated sheet metal absorber and a inexpensive double glazed cover. The heat is transported in two ductwork systems (east and west) with a radial DC-driven fan each. The fan energy comes from photovoltaic cell panels attached to the south facade between the ground and first floor.

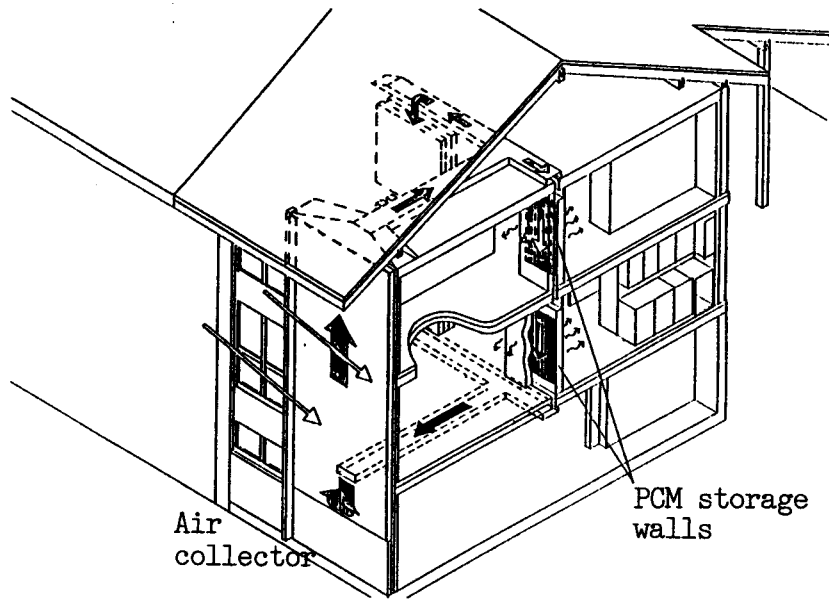

System Perspective

**STORAGE WALLS**

The heat is thought to be stored in four storage walls forming the partitions between south and north rooms. The walls are roughly 2 x 1.5 m and contain phase change material (PCM) storage material packed in tubes having a length of 1 m and a diameter of 4 cm. The PCM material is gelled Glauber's salt with a melting point of 31 °C.

**PHASE CHANGE MATERIAL****CHARGING**

During the charge periods the collector-heated air flows through a small free space down along the PCM tubes. The heated air is in contact with slightly more than half of the surface area of the tubes.

The rest of the tube surface area is embedded in a 12 cm layer of concrete through which the heat release occurs passively to the north rooms by conduction, providing an additional delay of the heat release. The storage is insulated against the south rooms to avoid competition with the direct solar gains from the windows.

The only auxiliary heating is provided by wood burned in a recirculating fireplace in the living room. The heat is distributed in the whole house by a separate air ductwork system.

Analysis was performed using the program DEROB. Several sunspace types and an air collector with and without storage were compared.

All sunspace variations were assumed to have double glazing, good frames and the house door to the sunspace opened only when sunspace temperature exceeds 21 °C.

**HEAT RELEASE**

**AUXILIARY HEATING SYSTEM**

**4.0 ANALYSIS**

**4.1 SUNSPACES**

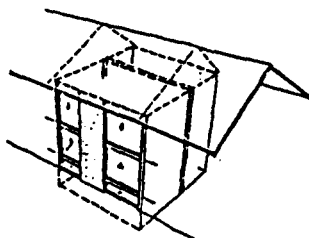

direct gain

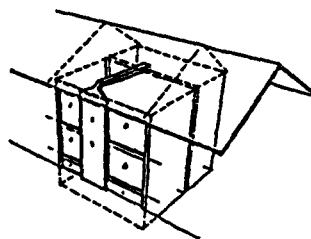

air collectors

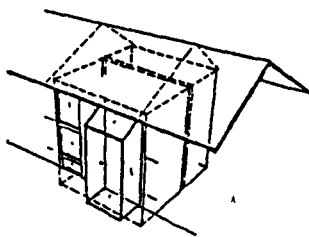

narrow sunspace

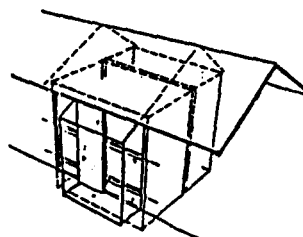

wide sunspace

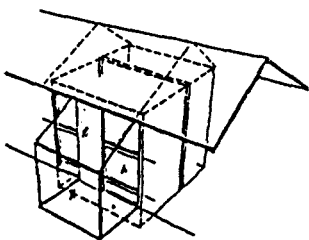

wide and deep sunspace

Investigated solar design options

It is not advisable to have uninsulated opaque side walls on the sunspace. Insulated side walls provide a better energy balance than glazed side walls (east or west-facing). Simulations indicate a 10 percent higher mean sunspace temperature with no freezing hours.

**SUNSPACE SIDE WALLS**



Measurements made include:

- Climatic parameters:** Global and diffuse horizontal and collector surface solar radiation, dry bulb temperature, wind speed and barometric pressure
- Interior temperature parameters:** Drybulb temperatures in 13 rooms, window status in living room
- Solar air circuit:** Inlet and outlet drybulb temperatures of collector and storage walls, air flowrates, collector absorber surface temperature, voltage and current of 1 fan.
- Storage walls:** Several salt temperatures in each storage wall and heat flows on the north surfaces.
- Auxiliary heating:** Fan on/off, air dry bulb temperature.
- Consumption:** Global electric energy, electric energy for heating (part of the monitoring period).

The total energy consumption of the building during the monitoring period was:

- Wood:	2,520 kg	=	10,850 kWh
- Electric energy for heating:			1,411 kWh
- Electric energy for DHW			2,362 kWh
- Electric energy for general use			4,646 kWh

5.3 PERFORMANCE RESULTS

The electric energy consumption for heating was used to heat the building during the whole month of March, because the recirculating fireplace does not allow a proper overall building heat balance. Thanks to this electrically heated period it was possible to estimate the COP of the fireplace, which is around 50%. The consumed electric energy is equivalent to 660 kg of wood, resulting in an equivalent annual wood consumption of 3,180 kg. Figure 2 shows the monthly total heating energy demand and the portions of the several contributing sources.

ENERGY CONSUMPTION

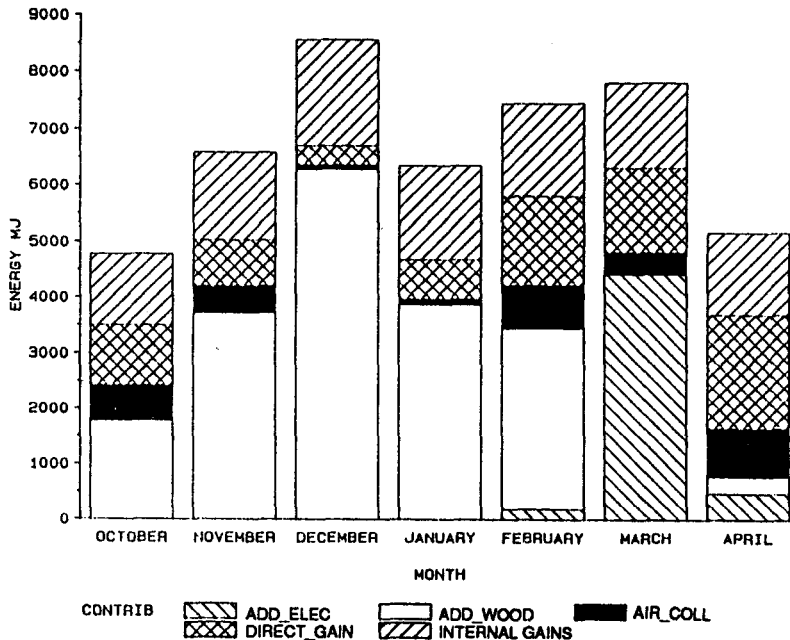
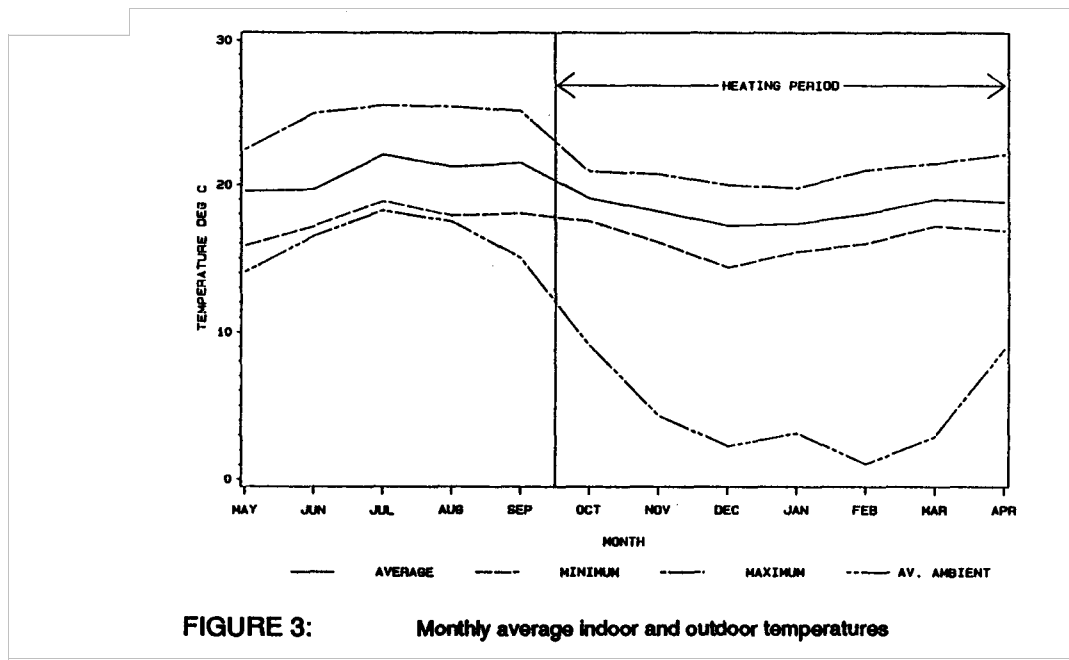

FIGURE 2: Monthly heating energy demand

**HYBRID SOLAR HEATING  
SYSTEM PERFORMANCE**

Concerning the hybrid solar heating system, one recognizes that its contribution is smaller than the direct gain and that it does not follow its profile as one would expect it to do (windows and collector are laying in the same plane). The reason is that the collector system was out of operation during several periods with good radiation. The temperature difference control did not work properly. The energy loss due to this fact has been quantified: the measured annual collector energy output is 4,582 MJ or 7.8 % of the total heat demand. It is estimated to be 5,767 MJ or 9.8 % of the total demand with a proper collector operation. The wood consumption would be 3,780 kg without collector system and about 750 kg or 20 % less (3,030 kg) with a properly operating one. A part of the direct gain is attributable to passive solar, too, because special measures are taken for a better utilization factor. However it is impossible to quantify the amount, because overheating never occurred during the monitored heating period due to low indoor temperatures (see figure 3) caused by the poor auxiliary heating system. Figure 3 shows the monthly average indoor and outdoor temperature for the monitoring period. The indoor temperature is the average of 10 measured values in different rooms forming the heated area.

**TEMPERATURES**

**FIGURE 3: Monthly average indoor and outdoor temperatures**

The curve shows that the building did not meet the usual thermal comfort conditions (18 to 20 °C) during the heating period. During the months November through February, it was too cold. This is the reason why the energy from direct gain and collector system (with badly operating storage walls, see below) could always be used without a risk of overheating. This is a result of the auxiliary heating system, which needs considerable maintenance to operate properly and which has a poor distribution effect. The passive and hybrid solar measures were effective in providing useful heat to the house.



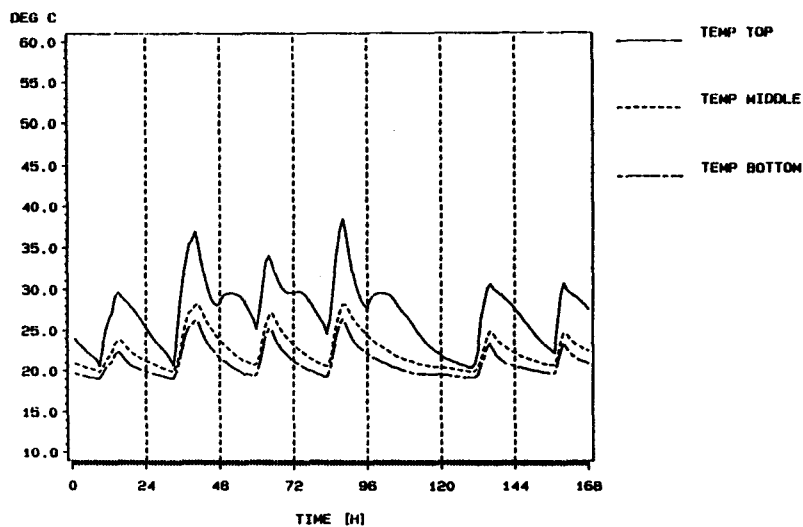

**FIGURE 4:** Temperature curves of a storage wall for one week

Figure 4 shows the temperature curves in one of the storage walls during a week with several clear days. The temperature at the top of the wall rises to about 35 °C on a clear day. During the following night it falls to about 25 °C, forming a terrace around the melting point of the salt. The terrace does not appear during the charging time, which is due to measuring effects: the sensors are not in the middle of the tubes, but on the inner side of the tube walls, recording a temperature more influenced by the hot air temperature than by the salt temperature. The two other temperatures in the wall never reach a level above the melting point; the salt stays solid in this area. The same behaviour was recorded for the other storage walls and was recorded after changing the fans to increase the air flow rates. This means, that a large part of the PCM storage material in this building is not active, and where it is, the latent heat is released within one night. The reason this occurs is the high wall conduction - or a too high melting point relative to this good conduction, respectively -, which releases heat to the rooms too quickly. This condition is exacerbated by thermal bridges.

The occupants are satisfied with the house in general, but not with its thermal comfort. Their major complaint is the uneven heat distribution from the auxiliary heating system, leading to very low bathroom temperatures, and the insufficient performance of the auxiliary heating in general. The system will be improved before the next heating season. They would also like to make more use of the solar collector by producing domestic hot water during the summer.

#### STORAGE WALLS

#### 5.4 OCCUPANT EVALUATION

**6.0 ECONOMICS**

The selling price of the unit is approximately sFr. 500,000.-, which is low for Swiss circumstances and has to do with a very low land price and the non-speculative nature of the complex.

**6.1 ADDITIONAL COSTS**

This price includes additional costs for the whole collector/storage system of about sFr. 26,000.-, of which the storage walls is sFr. 10,800.-.

**6.2 COST EFFECTIVENESS**

With these additional costs, it is impossible to speak about cost effectiveness. However, this was not the objective of this prototype building. The high costs are due to the special construction for the whole collector system. For future systems, costs should be reduced by simpler construction and the use of prefabricated elements.

**7.0 CONCLUSIONS**

The project did not succeed to demonstrate the applicability of PCM storage materials in hybrid solar heating systems. Additional research is necessary to achieve better performance at lower construction cost. Modifications are planned in the studied project within the next few years to improve its thermal performance and comfort.

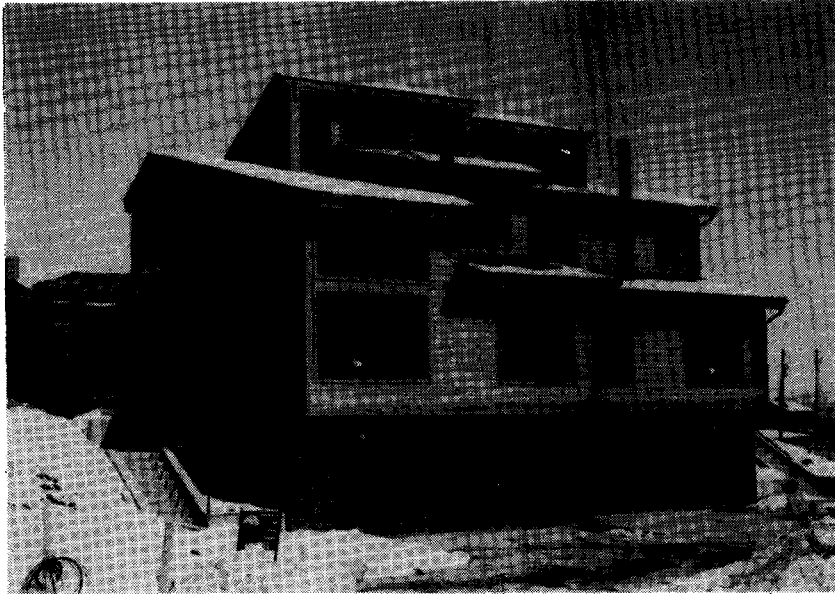

## 1.0 GENERAL

The Wonderland Homes project consists of two single family attached dwellings, called a duplex, located on a south sloping site in Boulder, Colorado. The energy design features are a combination of improved energy conservation, through added wall and ceiling insulation and infiltration reduction, and passive solar gain from south facing window

### 1.1 PROJECT DESCRIPTION

### 1.2 PARTICIPATING ORGANIZATIONS

<b>Architect:</b>	Downing-Leach Associates 1881 9th Street, Suite 103 Boulder, Colorado 80302
<b>Contractor:</b>	Wonderland Homes Development Corporation 1881 9th Street, Suite 203 Boulder, Colorado 80302
<b>Energy and Monitoring Consultant:</b>	Architectural Energy Corporation 2540 Frontier Avenue, Suite 201 Boulder, Colorado 80301
<b>Sponsor:</b>	U.S. Department of Energy Solar Buildings Program Washington, DC 20585

Documentation of the Wonderland Homes Project House can be found in the following reports:

*Design Guidelines for the Wonderland Homes IEA Task VIII House*, Architectural Energy Corporation, January 1985.

*IEA Task VIII Residential Design-Build Projects: Preliminary Energy Analysis*, R. Teller and M. Holtz, Proceedings of the 10th National Passive Conference, October 1985.

*Performance Evaluation Objectives and Monitoring Plan for the Wonderland Homes IEA Task VIII Project*, Architectural Energy Corporation, January 1987.

*Documentation of the Design and Performance of the Wonderland Homes Passive Solar Home*, Architectural Energy Corporation, June 1988.

### 1.3 PROJECT REPORTS

**2.0 CONTEXT**

**2.1 DESIGN OBJECTIVES**

The Wonderland Homes design is a prototype design for low density attached housing, sensitive to both local climatic and market conditions. Situated in an upper middle class neighborhood, the design is a practical, salable house that is significantly more energy efficient than comparable new housing.

**2.2 LOCATION**

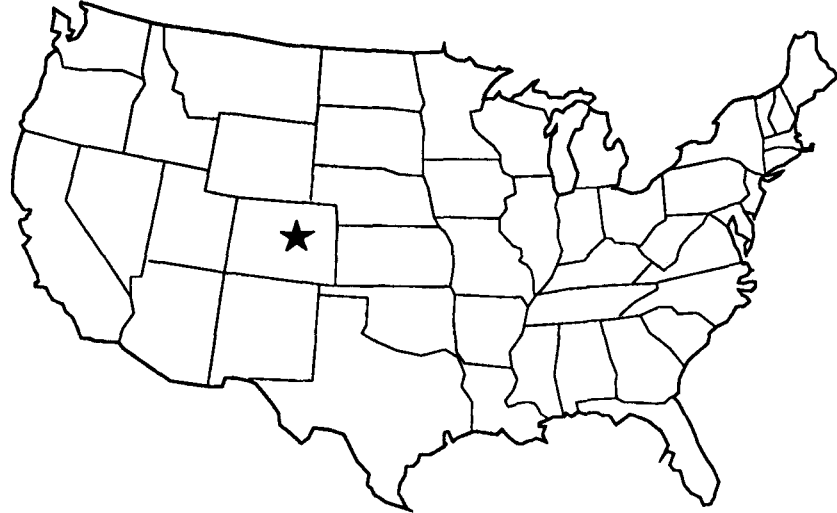

**Latitude: 40.01° N Longitude: 105.68° W Altitude: 1733.72 Meters above Sea Level**

**2.3 CLIMATE**

The Colorado climate, in general, is characterized by a cold sunny heating season and a warm dry cooling season. The Rocky Mountains that divide the state from east to west dominate the daily and seasonal weather patterns. Long term climatic data for Boulder, Colorado are shown below.

<b>Average Annual Temperature.....10.0° C</b>	<b>Degree Days (18.3° C Base)..3842HDD</b>
<b>Average Winter Temperature.....3.7° C</b>	<b>Global Irradiation.....17,800 KJ/m<sup>2</sup></b>
<b>Average Summer Temperature..18.5° C</b>	<b>Diffuse Portion.....25%</b>
<b>Average Annual Relative Humidity.52%</b>	<b>Sunshine Hours.....3295</b>

**3.0 DESIGN**

**3.1 ARCHITECTURAL DESIGN**

The duplex is located on a south sloping site. Primary vehicle access is from the south with occupant entrances to the dwelling units on the east and west. A two car garage for each dwelling and unfinished living and storage spaces are placed into the hillside. The primary living areas are above grade. The larger west unit features a master bedroom suite on the main living level, and a two story living room with an overlook from the upper level. Two additional bedrooms are located on the upper level. This unit totals 145.86 square meters of living space. The smaller east home has 132.38 square meters of living space and includes two bedrooms and a study that can be converted to a third bedroom all on the upper level. Both homes have large clerestory windows for added solar gain and light.

Marketing considerations influenced the sizing of south windows. Because of the excellent views of the mountains and the desire for greater daylighting, south window area exceeds the recommended six percent glazing to floor area ratio for a lightweight building by three percent. All windows are double glazed, although double glazing with a low-emissivity coating was recommended. The south windows are shaded by fixed overhangs; movable shading devices were the recommended approach.

The clerestory windows provide a double benefit. First, and foremost, they are part of the direct gain passive heating system of the home. Secondly, they provide an often overlooked daylighting benefit. Spaces on the north side of the upper levels will receive "borrowed" light through glazing on the upper portion of interior walls. This added light permits glazing on north walls to be reduced while also providing a cheerful, daylit space.

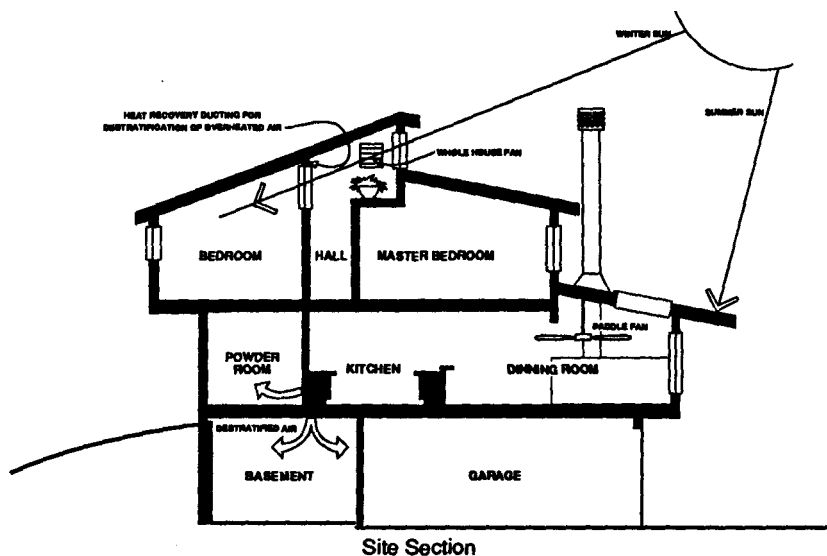

Site Section

The roof insulation level of RSI-6.7 is achieved by using two layers of RSI-3.3 batt insulation, with a layer of reflective foil attached to the insulation facing the air space between the insulation and the roof. The foil acts as a radiant barrier and raises the effective R - value of the roof in the winter, and helps reduce overheating in the summer. Construction detailing was carefully controlled to minimize thermal bridges, and to achieve proper ventilation of the roof insulation. Frame walls contain RSI-3.3 batt insulation. Foundation walls are insulated with an extruded polystyrene insulation (RSI - 1.8) on the exterior so that the mass of the concrete walls on the inside will absorb solar heat ducted to the lower spaces by the fan powered air circulation systems. Thermal bridges are reduced through this technique as well.

The targeted infiltration rate for the homes is 0.5 air changes per hour. To accomplish this level of "tightness", the exterior wall sheathing was covered completely with an air barrier "house wrap", and a vapor barrier was installed beneath the drywall. In addition, high quality, low infiltration windows and doors were used. Insulating foam sealant was placed around window and door openings, electrical outlets, and plumbing penetrations to reduce air infiltration.

## 3.2 ENERGY DESIGN

### PASSIVE SOLAR APERTURES

### ENVELOPE INSULATION

### INFILTRATION REDUCTION

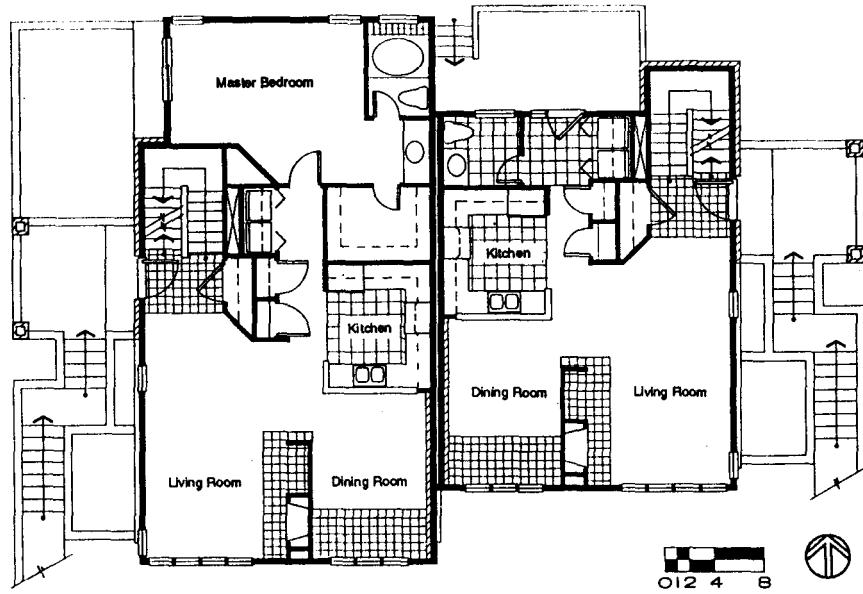

Main Level Floor Plan

**THERMAL MASS**

A small amount of thermal mass has been added to each dwelling in the form of interior brick walls. The thermal mass absorbs a portion of the passive solar gains. The brick walls are located on the common wall between the living units and also assist in reducing sound transmission. The local housing market values interior brick as a sign of quality.

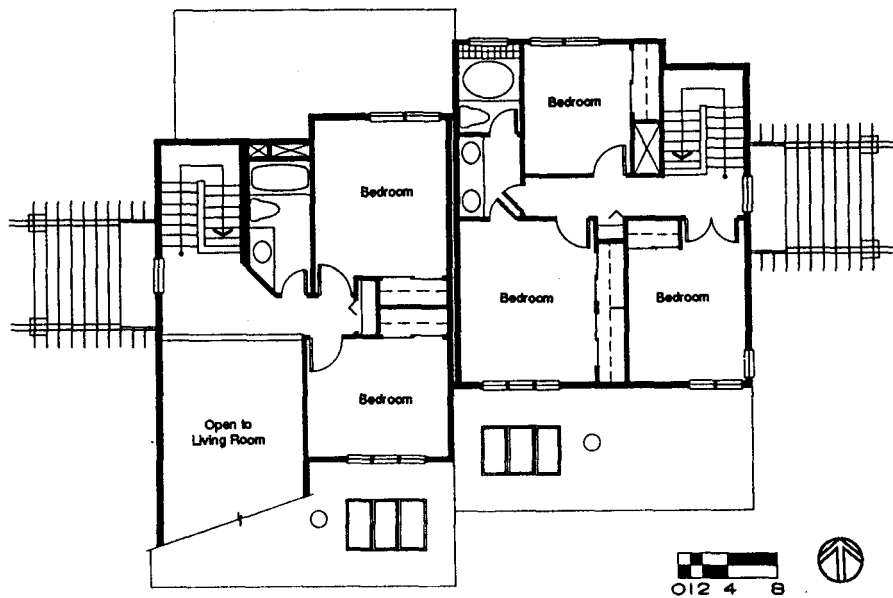

Upper Level Floor Plan

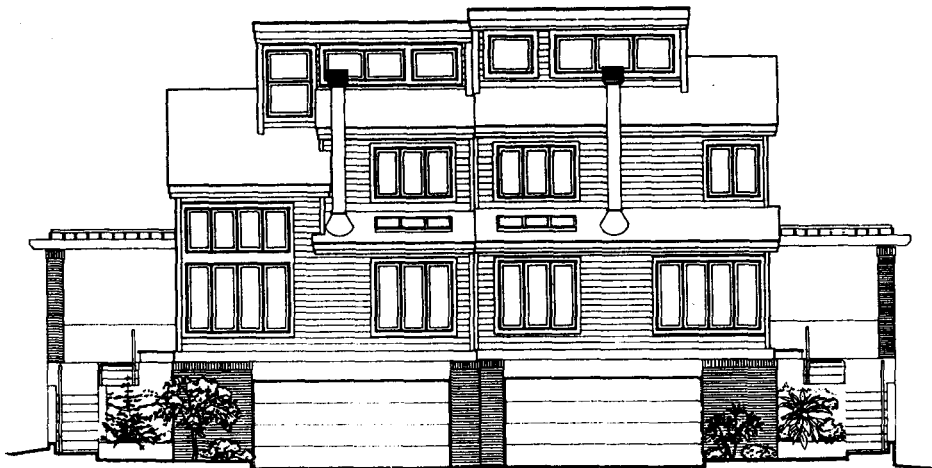

South Elevation



A fan and duct system captures heated air from behind the clerestory and distributes it to the lower living areas to reduce stratification. During the summer, a whole house fan aids in exhausting interior air at a rate of about 10 air changes per hour. Ceiling mounted paddle fans are used to provide additional occupant cooling in the main living areas.

**AIR CIRCULATION**

An active solar domestic hot water system is offered to the potential home buyer as an option. In this region of the United States, more than 300 sunny days a year make solar water heating a viable option for supplying up to 75% of a home's hot water needs.

**DOMESTIC HOT WATER**

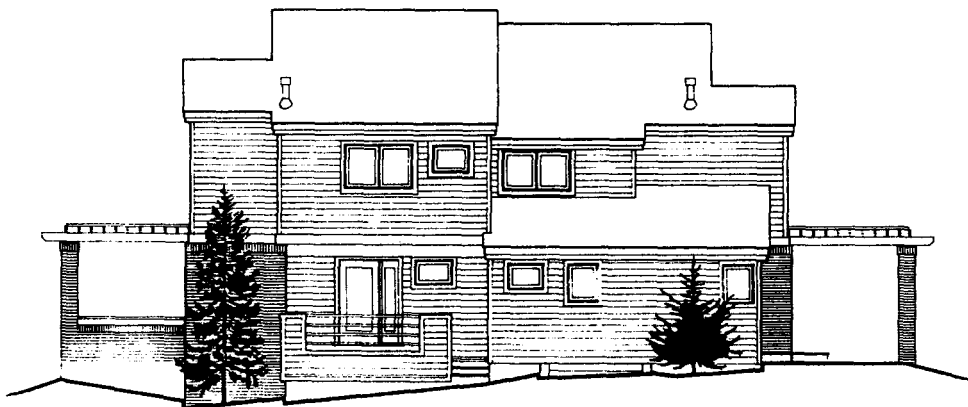

North Elevation



#### 4.0 ANALYSIS

Analysis of the Downing-Leach Associates' design was performed by Architectural Energy Corporation using the SUNCODE/PC® energy analysis program. The energy analysis was performed in two stages. The results of the first stage are displayed in Figure 1. The "Reference Building" in this case is characterized by RSI-2.1 walls and floor, RSI-4.2 ceiling, 1 air change per hour (ACH), and double glazing. The "Insulated Box" has RSI-3.3 walls and floor, RSI-5.3 ceilings, .4 ACH and triple glazing. The "Solar Box" has south glazing area equal to 8% of total floor area. The Downing-Leach design shows similar performance to the "Solar Box", but makes use of compensating effects to arrive at this level. The first stage design uses RSI-5.3 floor insulation above the unheated garage (assumed to be at ambient temperature) rather than the RSI-3.3. On the other hand, glazing is double pane rather than triple, and has a larger area than recommended. Recommended glazing levels are 6% of floor area for south windows and 2 to 2.5% for east or west windows. The initial design had from 9 - 14% south glazing on a zone by zone basis and 10% on the west. The higher floor insulation and higher solar transmission values compensated for the greater conduction losses due to increased glazing area and lower glazing thermal resistance. Of greatest concern in this initial design was the potential for year round overheating due to the large glazing area. Energy analysis in the second stage of the process focused on the determination of an appropriate level of glazing, especially on the south.

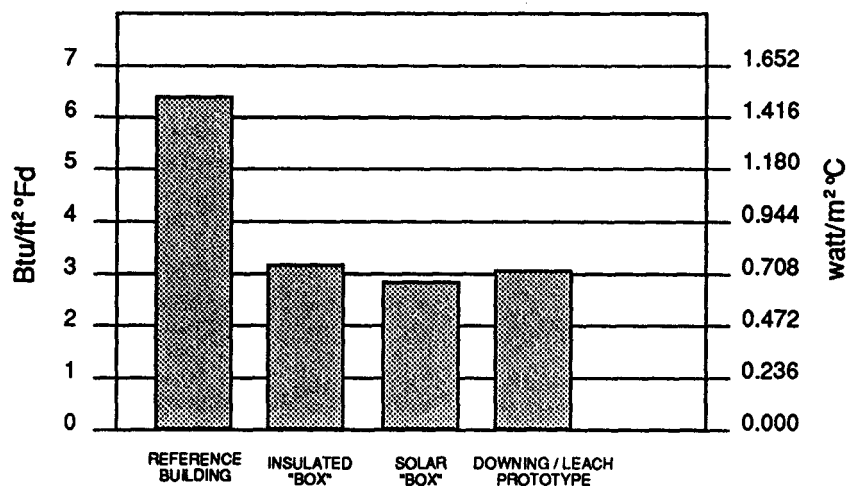

FIGURE 1 First Stage Energy Analysis Results

The effects of interzone fan coupling, particularly between the clerestory and the north bedroom on the upper level and to the basement were also investigated. Although it is possible to distribute heat from the clerestory to any other zone in the house, the evaluation of the benefit of such a strategy was done on the basis of reducing the seasonal heating load. A small effect was observed due to coupling the clerestory and the north bedroom. Since this design is characterized by a low level of thermal mass, little heat is stored during sunlight hours. Some heat is moved to the north bedroom, but even this zone has a relatively small daytime heating load. The heating load of the basement is smaller still, because of the strong ground coupling. Thus, only a small reduction of seasonal heating requirement was observed as a result of fan coupling between the clerestory and the basement. Various combinations of glazing type,



glazing area, added thermal mass and fan coupling were modeled. The results of some of these analyses are shown in Figure 2.

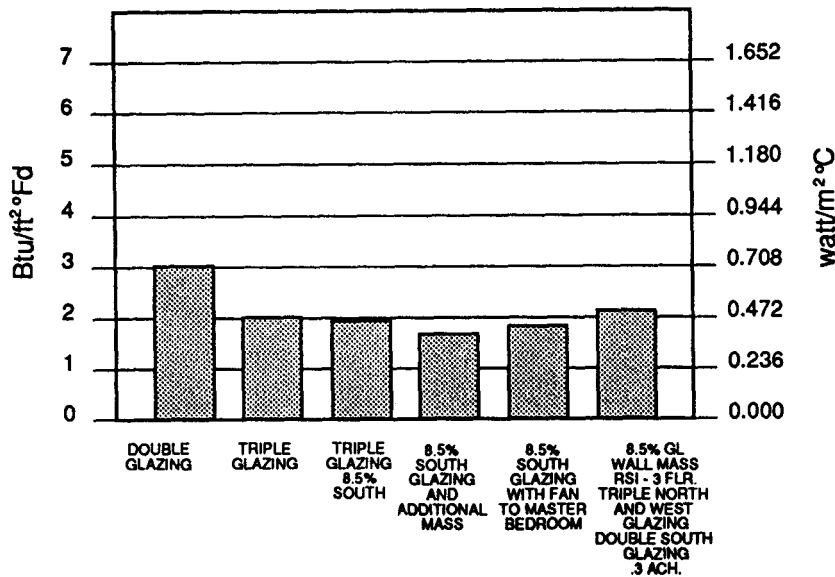

FIGURE 2 Second Stage Energy Analysis Results

The monitoring objectives for the Wonderland Homes house are to:

- o assess the reduction in building heating load and the consumption of non-renewable energy of the passive solar home compared to a conventional home; and
- o assess the year round comfort conditions of the passive solar home.

## 5.0 MONITORING

### 5.1 MONITORING OBJECTIVES

The data acquisition equipment consists of a computerized data logger and sensors. The data logger is based on a NEC PC-8201A portable computer with 32K of memory, two Fowlkes Engineering SAM 8.12.4 data acquisition modules, J-Cat auto-answer telephone modem by Novation and power supplies, battery, electrical surge protection and cables. The computer is programmed in Microsoft Basic. Channels are polled every 10 to 15 seconds by the computer, depending on the total number of sensor channels connected, and channel averages or totals are stored in memory on an hourly basis. Using a personal computer at Architectural Energy Corporation's office, the hourly files are retrieved over the telephone modem and stored on disks for analysis and plotting.

### 5.2 MONITORING SYSTEM

Measurements made include:

**Climatic Parameters:** Solar radiation, dry bulb temperature and wind speed.

**Energy Consumption Parameters:** Total electrical power, clothes dryer electrical power, electrical power for uses outside the home, water heater gas input, and furnace gas input.

**Interior Temperature Parameters:** Basement, first and second floor space air temperatures, mean radiant temperature, thermal mass temperature, furnace supply and return air temperatures.

5.3 PERFORMANCE RESULTS

The monthly results of the performance monitoring and of the SUNCODE/PC® simulations are shown in Figures 3 and 4. Each performance bar is divided into three segments. The lower, dark colored, segment is the amount of energy delivered to the building from the heating system. The middle, unshaded portion, is the energy provided by the internal gains, and the upper, shaded portion, is the energy provided by passive solar gains. The entire height of each bar is the monthly total heating load.

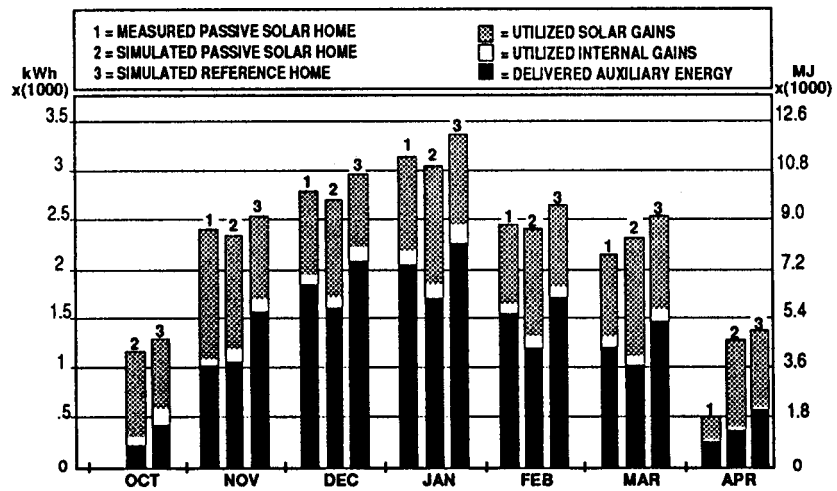

FIGURE 3 Monthly Space Heating Load, West Unit

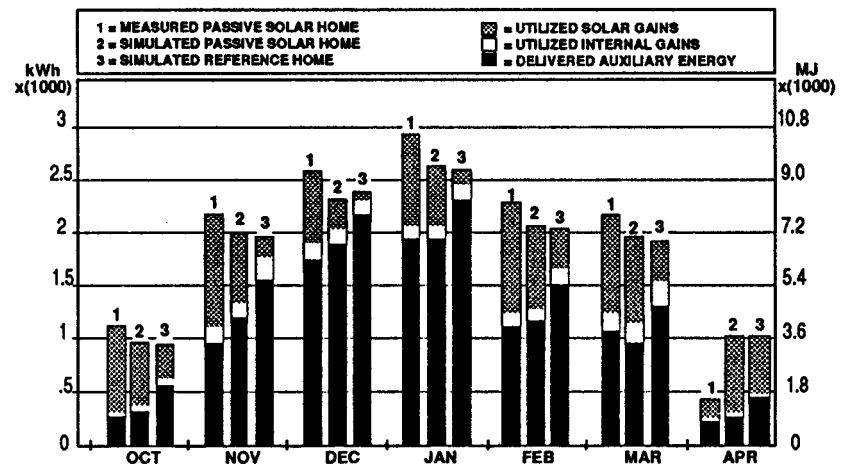

FIGURE 4 Monthly Space Heating Load, East Unit

The only physical differences between the simulated reference homes and the simulated passive solar home are that the reference homes have smaller window areas, less interior mass, and higher infiltration rates. They are the same in all other respects, including gross wall areas and insulation levels. The SUNCODE/PC® simulations for the reference and passive homes were driven with weather data collected during the performance monitoring period and with internal gains and thermostat settings similar to what were used in the actual homes.

The reference homes are more energy efficient than most new homes built in the Denver, Colorado area. Two reasons may be cited for this. One is that the local building code requires energy efficient design and construction for all new homes; consequently, the levels of insulation assumed for the reference houses are higher than they would be in many other locations. The second is that the homes share a common wall which makes their heating and cooling loads smaller than loads for single family detached houses. Because the energy requirements of the reference houses are small to begin with, the savings attributable to passive solar are small and the investments in passive solar that can be justified are also small.

For each dwelling, the energy savings attributable to passive solar are estimated by subtracting the total heating load of the simulated solar building from the total heating load of the simulated reference building. For the west unit this is  $(36.8 - 26.2) = 10.6$  million Joules, and for the east unit it is  $(36.4 - 28.7) = 7.7$  million Joules. These are reductions of 29% and 21%, respectively. After accounting for the heating system efficiency, the actual energy savings will be approximately 65% greater than these load reduction values.

In each month, the passive solar homes required less auxiliary heating than the simulated reference homes. The auxiliary heating energy actually consumed in the west unit tends to exceed the simulated consumption for the passive home in the coldest months, while the actual energy consumption in the east unit is less than or equal to the simulated value through all months. The closely matched results provide confidence in the performance of the buildings as well as in the usefulness of computer models. The passive homes save energy and are comfortable.

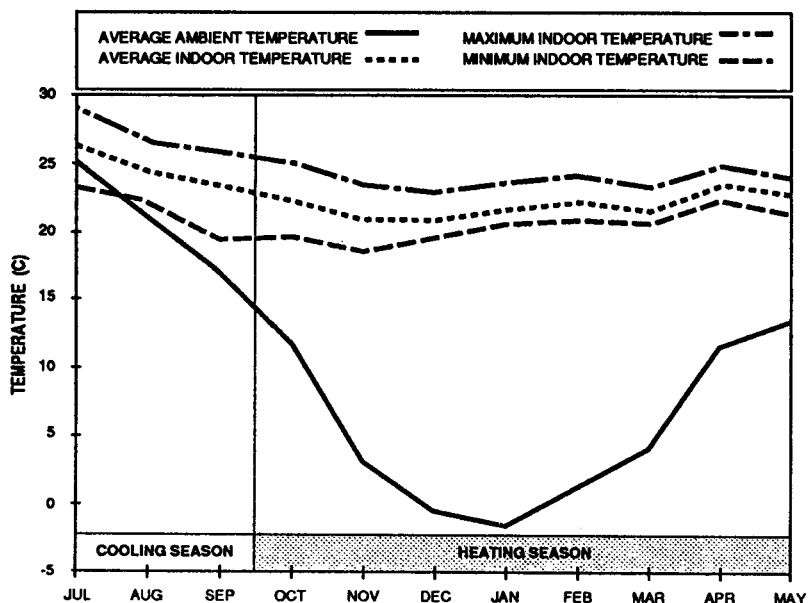

FIGURE 5 Indoor and Ambient Temperatures

The graphs in Figure 5 show the averages of maximum, minimum, and daily average indoor temperatures and average outdoor temperatures in the east unit for part of the cooling season and throughout the entire heating season. These temperatures are well within the range of

**5.4 OCCUPANT EVALUATION**

comfort with virtually no overheating problems. The minimum temperatures actually increased as the heating season progressed, due to changes in thermostat settings.

Interviews with the occupants of the passive solar homes determined that overall satisfaction, livability and comfort were excellent. They are pleased with the operating costs, and the houses are generally very comfortable. They enjoy the cross ventilation that is achieved by opening windows on opposite sides of the house for summer cooling, but note that the sun coming in the large south windows in the fall heated up the house more than they would prefer. They have noted that more thought goes into operating the building than they had expected and would recommend that houses in the future have automatic features, especially for shading windows.

Wonderland Homes estimates that the cost for the additional south glazing, thermal mass and air destratification system for both housing units was \$3,000 (U.S.). This represents approximately five percent of total construction costs. The added cost per unit is as follows:

**6.0 ECONOMICS**

**6.1 ADDITIONAL CONSTRUCTION COSTS**

	West Unit	East Unit
Extra Glazing on South	\$ 1105.00	None
Added Thermal Mass	\$ 660.00	\$ 660.00
Air Destratification System	\$ 250.00	\$ 250.00
Controls	\$ 35.00	\$ 35.00
<b>Total Additional Cost</b>	<b>\$ 2050.00</b>	<b>\$ 945.00</b>

**7.0 CONCLUSION**

This project demonstrates that an energy savings of forty percent or more relative to the norm in Colorado, can be obtained in a marketable housing product at no more than five percent extra costs, with a careful approach to design and construction that is sensitive to local climate and housing market conditions.

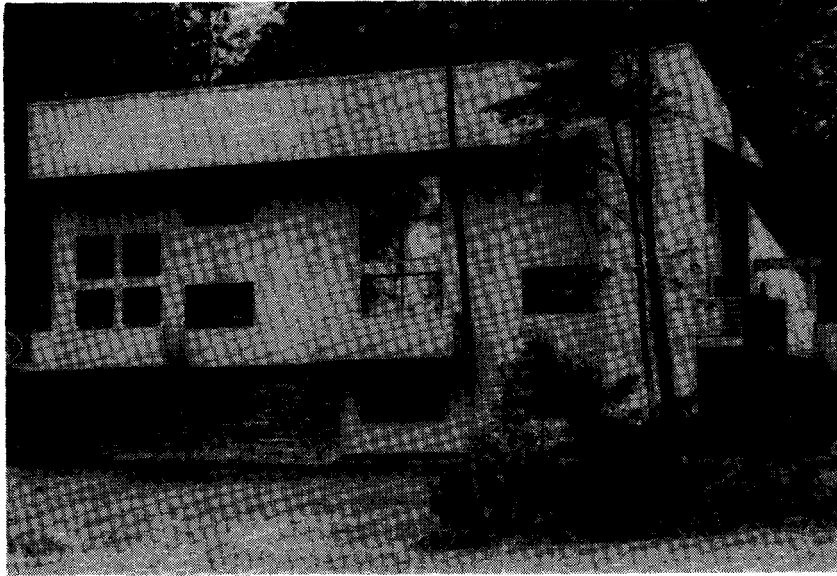

## 1.0 GENERAL

The Santa Fe Development project consists of a single family detached residence located on a sloping site in Oakton, Virginia. The energy design features are a combination of improved energy conservation through added wall and ceiling insulation, reduced infiltration, an efficient mechanical system, and passive solar gain from south facing windows.

### 1.1 PROJECT DESCRIPTION

**Architect:** Archetype  
1841 Columbia Road, N.W. ,Suite 202  
Washington, DC 20009

**Contractor:** Santa Fe Development Corporation  
8115 Old Dominion Drive  
McLean, Virginia 22101

**Energy and Monitoring Consultant:** Architectural Energy Corporation  
2540 Frontier Avenue, Suite 201  
Boulder, Colorado 80301

**Sponsor:** U.S. Department of Energy  
Solar Buildings Program  
Washington, DC 20585

### 1.2 PARTICIPATING ORGANIZATIONS

Documentation of the Santa Fe Development house can be found in the following reports:

*Design Guidelines for the Santa Fe Development IEA Task VIII House*, Architectural Energy Corporation, January 1985.

*IEA Task VIII Residential Design-Build Projects: Preliminary Energy Analysis*, R. Teller and M. Holtz, Proceedings of the 10th National Passiva Conference, October 1985.

*Performance Evaluation Objectives and Monitoring Plan for the Santa Fe Development IEA Task VIII Project*, Architectural Energy Corporation, January 1987.

*Documentation of the Design and Performance of the Santa Fe Development Prototype Passive Solar Home*, Architectural Energy Corporation, June 1988.

### 1.3 PROJECT REPORTS

**2.0 CONTEXT**

**2.1 DESIGN OBJECTIVES**

The Santa Fe Development project is a prototype for low density detached housing sensitive to both local climate and market conditions. The client is a speculative housing developer offering "for sale" housing in the suburban Washington, DC area. The program for the 313 square meter house responds to typical market needs: living room, dining room, family room, kitchen, three bedrooms, master bedroom suite, recreation room, three and a half bathrooms and a two car garage.

**2.2 LOCATION**

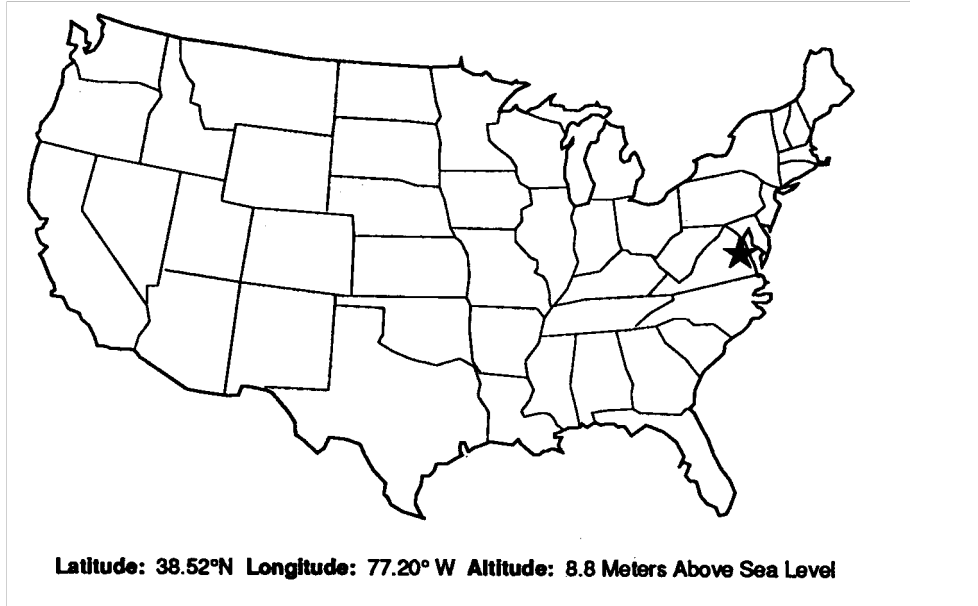

**2.3 CLIMATE**

The climate of the central atlantic states is characterized by a cold cloudy heating season and a hot and humid cooling season. Temperatures of the coastal area are moderated during both heating and cooling season by the Atlantic Ocean and the shore winds, respectively. Inland areas are cooler in winter and warmer and more humid in summer. Long term climatic data for Washington, DC are shown below.

<b>Average Annual Temperature....12.2° C</b>	<b>Degree Days...(18.3° C Base) .2576 HDD</b>
<b>Average Winter Temperature.....5.9° C</b>	<b>Global Irradiation.....13,714 KJ/m²</b>
<b>Average Summer Temperature..20.6° C</b>	<b>Diffuse Portion.....40%</b>
<b>Average Annual Relative Humidity..67%</b>	<b>Sunshine Hours.....2621</b>

**3.0 DESIGN**

**3.1 ARCHITECTURAL DESIGN**

The prototype house is located on a wooded, south sloping site. Vehicle access is from the north and the main entry to the house on the east. Two bedrooms, a recreation room, storage areas and a mechanical equipment room are located on the lower level, which opens at ground level to the south. The main or second level of the house contains the living room, dining room, kitchen, family room, and a circulation/solar collection area. The two car garage also is located on this level. The upper level, consisting of master bedroom and guest bedroom suites, overlooks the circulation/solar collection area. The guest bedroom suite can also be used as a study.

The Santa Fe Development house is one specific application of a prototype for low energy single family housing. It is a highly insulated box (insulation levels are RSI-3.3 for the walls and RSI-6.7 for the ceiling), framed in wood in a manner conventional to American housing, with prefabricated roof trusses which overhang to the south. The house is organized along the east - west axis. The long south facing wall extends three stories above grade, while the north wall is only two stories above grade.

Articulation of the box comes from the inside outward, creating the physical framework of solar collection, storage, and distribution interactions; an energy system architecture of space, structure and form. Trusses overhang to give form and shade. Decks and bay projections deepen the facade and shade it. Arrangement of uses within the house coincide with the house's form articulation and passive energy flows. As a linear organization, spaces are adjoined in a procession running east to west. Circulation linking the spaces runs parallel along the south wall of the house. This line of movement through the house is modulated by an interior masonry wall composed of brick that is banded with rowlock coursing. The wall has load bearing and space defining functions as well as providing thermal mass to help modulate interior temperatures.

Located on the north side of the masonry wall are the living spaces; each is a separate 'event', imparting its influence and determining how the wall is punctured. Additionally, these punctures overlay with window and stair components on the south side of the house to regulate the amount and location of sunlight penetration, and to frame views. The view lines in the north-south direction are also lines of ventilative air flow, reinforced with a small atrium located north of the dining room, for induced exhaust. The interior masonry wall provides architectural form in its response to these functions, on both the two story southern side (a spine of solar collection area), and within each adjoining living space. This configuration provides each living space with radiant thermal mass, and the house with an uninterrupted two story solar collection area along its south wall.

The circulation/solar collection zone is thermally open to the living spaces in this application for marketing reasons, yet the massing of the interior brick wall shields it from the inner spaces, with only passageway openings. It could be easily separated at every level through the introduction of doors and, at the upper level, floor to ceiling walls (often a preference) in the guest suite.

There is minimal glazing on the east, west and north facades for light, view, and ventilation. South glazing totals 10% of the floor area. All glazing is double glass with a low-emissivity coating. The wood frame, with fiberglass batt insulation, is sheathed with 1.56 cm high density rigid insulation then covered with tongue and groove wood siding. On the lower level, concrete block with brick veneer exterior walls are covered on the interior with 3.75 cm high density rigid insulation beneath sheetrock nailed to furring strips. The house sits on a 10 cm concrete slab.

## 3.2 ENERGY DESIGN

### ENVELOPE INSULATION

### FORM CONCEPT

### THERMAL MASS

### SOLAR COLLECTION ZONE

### GLAZING

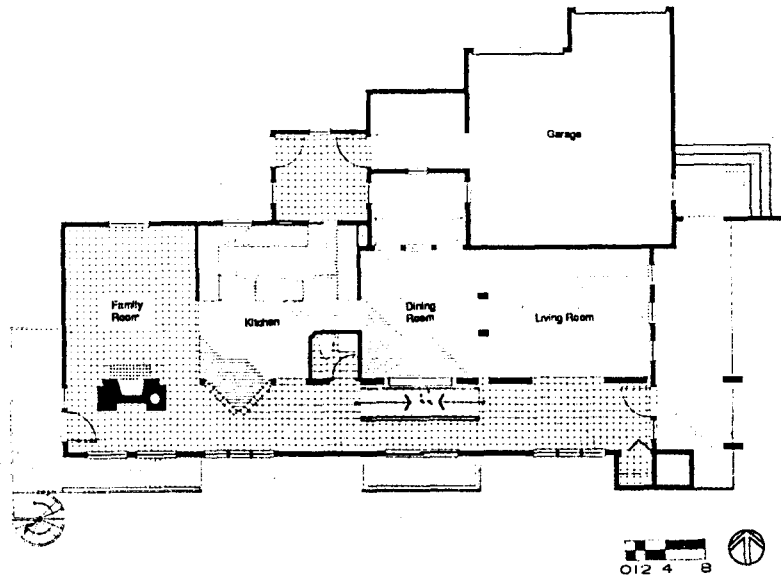

Main Floor Plan

**MECHANICAL HEATING AND COOLING EQUIPMENT**

Two high efficiency, all-electric, split system heat pumps serving separate zones of the house provide heating and cooling. In the heating mode the heat pumps will deliver 2.5 watts of heat for each one watt of power input. Performance in the cooling mode for the removal of heat is comparable. One heat pump serves the portions of the house that are commonly used by the family, the west zone. Comfort conditions will be maintained throughout the year. The other heat pump serves the areas used by the family when entertaining guests. Comfort conditions will be maintained in these areas only

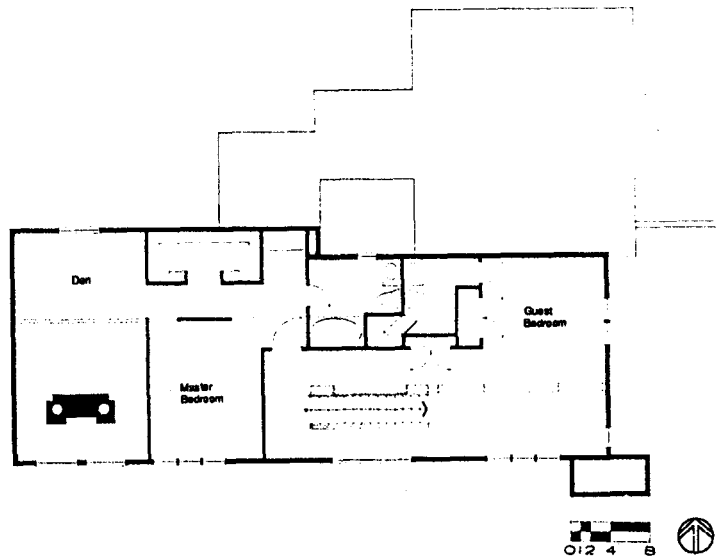

Upper Floor Plan



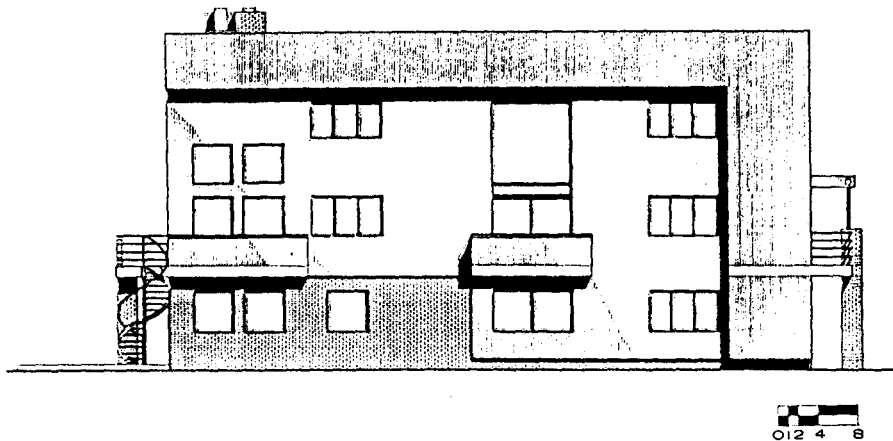

South Elevation

areas only during occupied periods. During unoccupied periods, heat will be provided to maintain a minimum temperature.

The ductwork system includes both a high and a low return air intake grill for each heat pump system. The use of both returns will provide even temperatures by destratifying air in the house. During the cooling season, the high returns may be closed; the warmest air will be above the occupied levels.

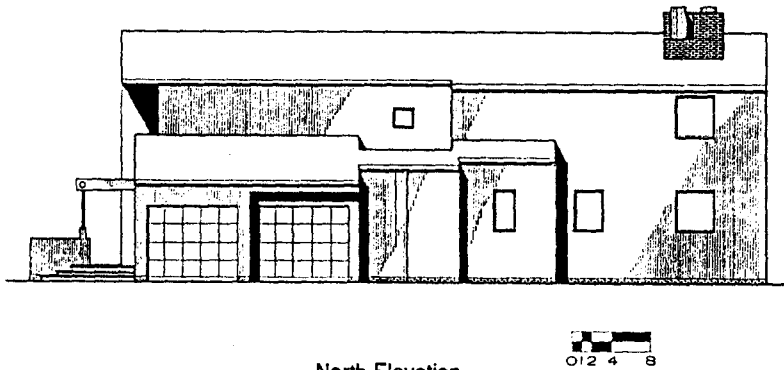

North Elevation

Analysis of the Archetype design was performed by Architectural Energy Corporation using the SUNCODE/PC® energy analysis simulation. Two stages of energy analysis were performed.

#### 4.0 ANALYSIS

The results of the first stage of energy analysis are displayed in Figure 1. The heating season performance, normalized to conditioned floor area, is shown for 4 different building configurations. The "Reference Building" is a 149 square meter "box" with insulation levels typical of

local construction practice (RSI-1.9 walls and floor, RSI-4.2 Ceiling, .8 ACH, and double glazing). The "Insulated Box" has the same dimensions but has levels of insulation appropriate for this climate (RSI-3.3 walls and floor, RSI-5.3 ceiling, .4 ACH, and double glazing). The "Solar Box" retains the same dimensions and insulation levels as the previous configuration but its south glazing area has been increased to 8% of total floor area, a level which optimizes heating season performance while minimizing year round overheating. The glazing distribution of the previous configurations was fixed at 10% of total floor area, equally distributed on all sides. The Archetype Prototype is the fourth configuration. As expected, the most dramatic improvement is associated with conservation features. The performance of Archetype's initial design compared quite closely with the "Solar Box", which reflects the usefulness of the design guidelines provided to the designer at the outset of the project.

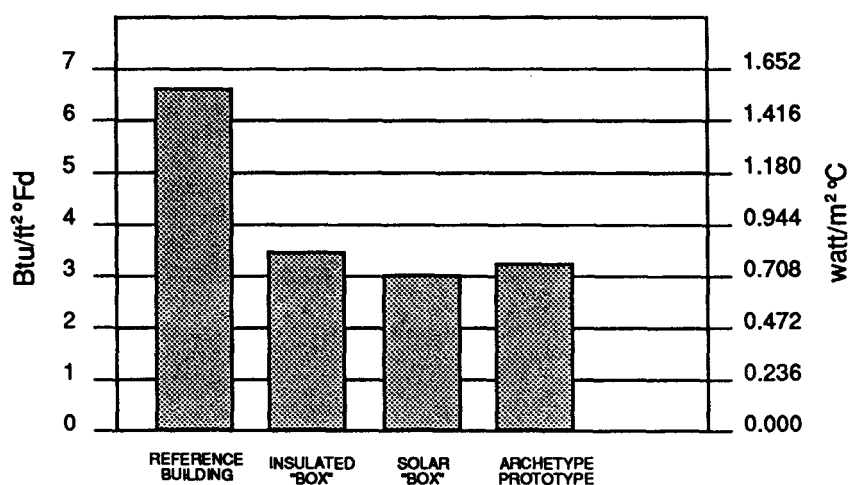

**FIGURE 1** First Stage Energy Analysis Results

The second stage of the energy analysis addressed questions more specific to Archetype's design. In addition to examining issues of glazing type, added south glazing area and added thermal mass area, two thermal zoning issues were raised. First, what would be the effect of isolating the circulation/solar collection zone from the rest of the zones by installing a combination of fixed single glass, French doors, and increased brick partition area? Second, what would be the effect of isolating the living/dining room from the kitchen/eating area and maintaining that zone at a reduced heating setpoint during unoccupied times? Figure 2 displays the results of these investigations. Although a steady improvement in heating season performance can be noted in each of these design modifications, no dramatic change occurs with a single modification. These results reflect not only the flexibility inherent in this design but also the fact that the seasonal heating requirement has been reduced as far as is reasonably possible and economically feasible.

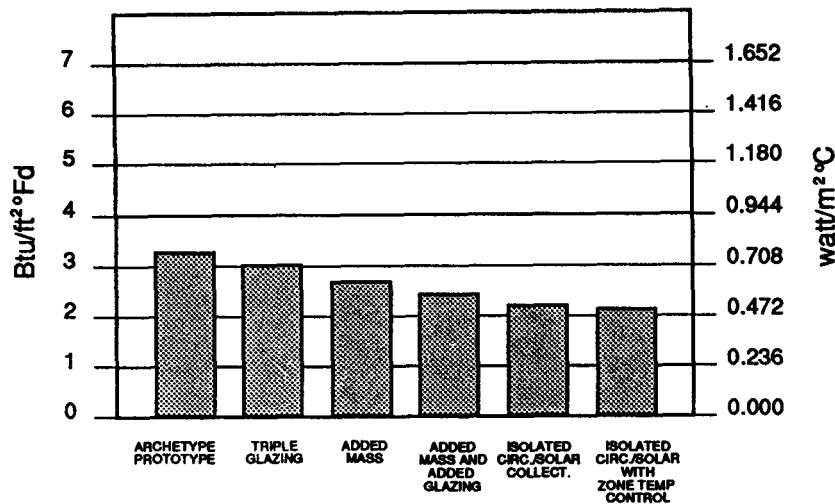

FIGURE 2 Second Stage Energy Analysis Results

The monitoring objectives for the Santa Fe Development house are to:

- o assess the reduction in building heating load and the consumption of non-renewable energy of the passive solar home compared to a conventional home; and
- o assess the year round comfort conditions of the passive solar home.

5.0 MONITORING

5.1 MONITORING OBJECTIVES

The data acquisition equipment consists of a computerized data logger and sensors. The data logger is based on a NEC PC-8201A portable computer with 32K of memory, two Fowlkes Engineering SAM 8.12.4 data acquisition modules, J-Cat auto-answer telephone modem by Novation and power supplies, battery, electrical surge protection and cables. The computer is programmed in Microsoft Basic. Channels are polled every 10 to 15 seconds by the computer, depending on the total number of sensor channels connected, and channel averages or totals are stored in memory on an hourly basis. Using a personal computer, the hourly files are retrieved over a telephone modem and stored on disks for analysis and plotting.

5.2 MONITORING SYSTEM

Measurements made include:

Climatic Parameters: Solar radiation, dry bulb and wet bulb temperatures and wind speed.

Energy Consumption Parameters: Total electrical power, clothes dryer electrical power, water

Parameters: heater electrical power, and heat pump electrical power consumption.

Interior Temperature Parameters: Basement, first and second floor space dry bulb and wet

Parameters: bulb air temperatures, thermal mass temperatures, mean radiant temperatures, heat pump supply and return air temperatures.

5.3 PERFORMANCE RESULTS

The monthly results of the performance monitoring and of the SUNCODE/PC® simulations are shown in Figure 3. Each performance bar is divided into three segments. The lower, dark colored, segment is the amount of energy delivered to the building from the heating system. The middle unshaded portion is the energy provided by the internal gains, and the upper shaded portion is the energy provided by passive solar gains. The entire height of each bar is the monthly total heating load.

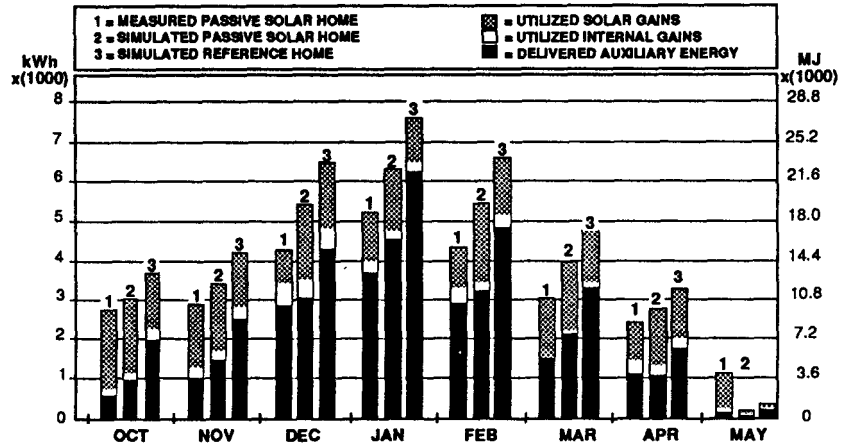

FIGURE 3 : Monthly Space Heating Load

The physical differences between the simulated reference home and the simulated passive solar home are that the reference home has less wall and ceiling insulation, smaller window area, less interior mass, and a higher infiltration rate. The houses are the same in all other respects, including gross wall area and volume. The SUNCODE/PC® simulations for the reference and passive homes were driven with weather data collected during the performance monitoring period and with internal gains and thermostat settings similar to those in the actual home.

The heating energy attributable to passive solar is estimated by subtracting the total heating load of the simulated solar building from the total heating load of the simulated reference home. These numbers result in an annual savings of  $(91.6 - 59.7) = 31.9$  million Joules, or a reduction of approximately 35%. Annual cooling loads in the solar home are higher than in the reference home because of the larger glazing area. The simulations indicate that the cooling load of the passive home is  $(17.3 - 11.3) = 6.0$  million Joules greater than the reference home. The net reduction in load for the passive home is 25.8 million Joules or approximately 24%. The actual energy savings is less than 25.8 million Joules because the coefficient of performance of the heat pump system is close to 2.0 during both the heating and cooling seasons.

In each month, the monitored passive solar home required less auxiliary energy than either the simulated reference home or the simulated passive solar home. The total heating load of the actual house was also less than that for either of the simulated homes. The utilized passive solar energy in the actual house tends to be less than the amount utilized in the simulated passive house, though more than

in the simulated reference house. The closely matched auxiliary energy results provide confidence in the calculations of the actual building's performance as well as in the usefulness of the computer models.

Annual consumption of electricity for three conventional homes, each similar in size and occupancy to the passive solar home and located in the same neighborhood, was compared to the annual consumption for the solar home. Overall, the passive solar home used 24% less energy. Of the total amount of energy used in the passive solar home, 34% was used for space heating, 13% for cooling, 21% for water heating, and 32% for all other uses.

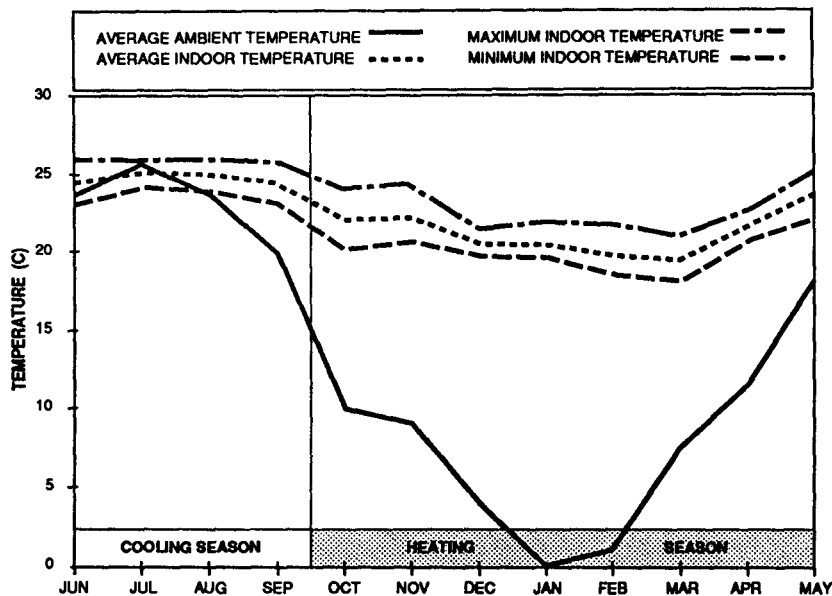

FIGURE 4 Maximum and Minimum Recorded Temperatures

Figure 4 shows the averages of maximum, minimum, and daily average indoor temperatures and average outdoor temperatures for the cooling season and the heating season. During the cooling season, the heat pump system maintained the maximum indoor temperature at a value of 26°C. Minimum and average daily temperatures are less than this, though only by one or two degrees C. During the heating season, the temperatures steadily decrease each month and reach a minimum in March. The average temperature for March is 19°C. This was not reported by the occupants as being uncomfortable. The house does not overheat in winter.

The occupants are extremely satisfied with the comfort, livability, and performance of their passive solar home and have reported no major problems or complaints. Their utility costs are much lower than their previous home which used fuel oil for space heating and hot water. The house is comfortable throughout the year, though a small electric heater is sometimes used in the master bathroom. Natural ventilation maintains acceptable levels of comfort during the spring and fall.

#### 5.4 OCCUPANT EVALUATION

## 6.0 ECONOMICS

### 6.1 ADDITIONAL CONSTRUCTION COSTS

The construction cost and selling price of the prototype passive solar home are typical for speculative built single family houses in this area of suburban Washington, DC. The passive solar prototype house cost \$656.56/square meter to construct and sold for \$993.69/square meter. A typical conventional house would cost \$614.41/square meter to construct and would sell for \$972.48/square meter.

Consequently, while the passive solar prototype house cost an additional \$42.15/square meter to construct compared to the typical conventional house, it sold for \$21.21 square meter more than the conventional house.

Most of the added construction cost for the passive solar prototype house is associated with the interior brick thermal mass wall and the improved low 'e' windows. These two elements represent approximately 20 percent of the total construction cost of the passive solar prototype, while they represent only 7 percent of the total construction cost in the typical conventional house. However, due to the higher market value of the passive solar home, the profit margin of both homes is approximately 35 percent.

### 6.2 COST EFFECTIVENESS

Based on current electrical energy costs, the Santa Fe Development prototype passive solar home is marginally cost effective. That is, the first cost of the passive solar design features is only partially offset by the energy savings over a 30 year period assuming a 10% interest rate. As electric energy costs increase, the cost effectiveness of the passive solar design features improves.

## 7.0 CONCLUSION

The Santa Fe Development project has successfully demonstrated that significant energy savings can be achieved in speculative built single family housing at reasonable construction costs. Also, year-round comfort and livability has been enhanced because of the passive solar design features.

A major conclusion of IEA research on passive and hybrid solar low energy residential design is that significant energy savings and improvement in comfort can be achieved by adhering to a few simple principles of energy design. These energy design principles or guidelines can be integrated into residential architecture while enhancing design flexibility and choice, affordability, durability, air quality, amenity and comfort, and marketability.

Another conclusion from the IEA research is that simple energy-saving strategies, such as improved envelope insulation levels or use of high performance glazings, are generally more effective and economical than complex energy-saving strategies. This conclusion points out the need to fully understand the energy use requirements in residential buildings and to develop solutions that are durable, affordable, and reliable to meet these requirements -be they simple or complex solutions.

The reader is encouraged to obtain the National Design Guidelines Booklet appropriate to his or her location. This booklet will provide location-specific advice and guidelines for designing energy-efficient, passive solar homes. The reader is also encouraged to obtain the other booklets in the Design Information Series. They will provide extremely valuable information concerning the design, construction, use, and evaluation of energy-efficient, passive solar homes.

Derickson, R. G. and Holtz, M.J. Climate Similarity as a Basis for Building Energy Design Guidelines Development, Architectural Energy Corporation, 1985.

