



SOLAR HEATING & COOLING PROGRAMME
INTERNATIONAL ENERGY AGENCY

LED Guideline

for the Promotion
of Lighting Retrofitting

A Brochure of IEA SHC Task 70 / EBC Annex 90
Low Carbon, High Comfort Integrated Lighting



IMPRINT

This document was prepared by Jan de Boer, Fraunhofer Institute for Building Physics Germany, Operating Agent of SHC Task 70 / EBC Annex 90 “Low Carbon, High Comfort Integrated Lighting” of the Solar Heating and Cooling Technology Collaboration Programme.

© IEA Solar Heating and Cooling Technology Collaboration Programme, www.iea-shc.org

The IEA SHC Technology Collaboration Programme (SHC TCP) is organised under the auspices of the International Energy Agency (IEA) but is functionally and legally autonomous. Views, findings and publications of the SHC TCP do not necessarily represent the views or policies of the IEA Secretariat or its individual member countries.

Status: July 2023

DOI: 10.18777/ieashc-task70-2023-0001

All rights reserved.

The contents of this guide may be reproduced for own purposes. Use in media e.g., in professional articles or paid publications, must be agreed with the authors prior to publication. We would like to point out that we exclude any warranty for the information contained in this guide. Liability of the institute or the authors for improper, incomplete or incorrect information and resulting damages is excluded in principle.

This work was partially funded in different projects by the “Fraunhofer Klimafond”, the German Federal Ministry for Economic Affairs and Climate Action (BMWK) and Federal Ministry for the Environment, Nature Conservation, Nuclear Safety and Consumer Protection (BMUV).

Cover |

View of a corridor area during the implementation of renovation construction measures. [© Fraunhofer IBP]

TABLE OF CONTENTS

	Page
1 What are the basic considerations that motivate lighting renovations?	5
2 How to approach a refurbishment: lamp replacement, 1:1 luminaire replacement, “deep retrofit”?	7
3 Why act now? Mercury vapor lamps – Everything has to go!	9
4 What is the state of the art in LED technology ?	11
5 LED vs. old systems: What are the “ Low Hanging Fruits ”?	15
6 LED replacement lamps or LED luminaires ?	17
7 Potentials in electric lighting – yes, of course. But what about façade and daylight ?	21
8 What are the potentials of light management ?	23
9 Bright rooms: friendly and very efficient!	25
10 Installation technology: How to convert efficiently?	27
11 Efficiency and cost-effectiveness: “ Return on invest in volatile times? ”	33
12 What financing and funding opportunities are available?	37
References	39
Appendix: Estimation tool for possible investment	41

1 | What are the basic considerations that motivate lighting renovations?

Global Electricity Energy Consumption

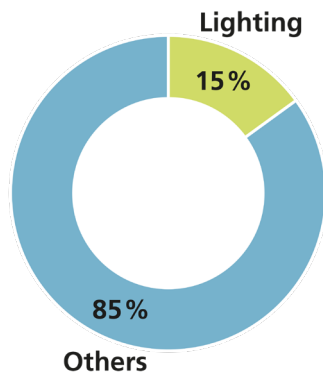

Figure 1 | Share of lighting in global electricity energy consumption. [© Fraunhofer IBP]

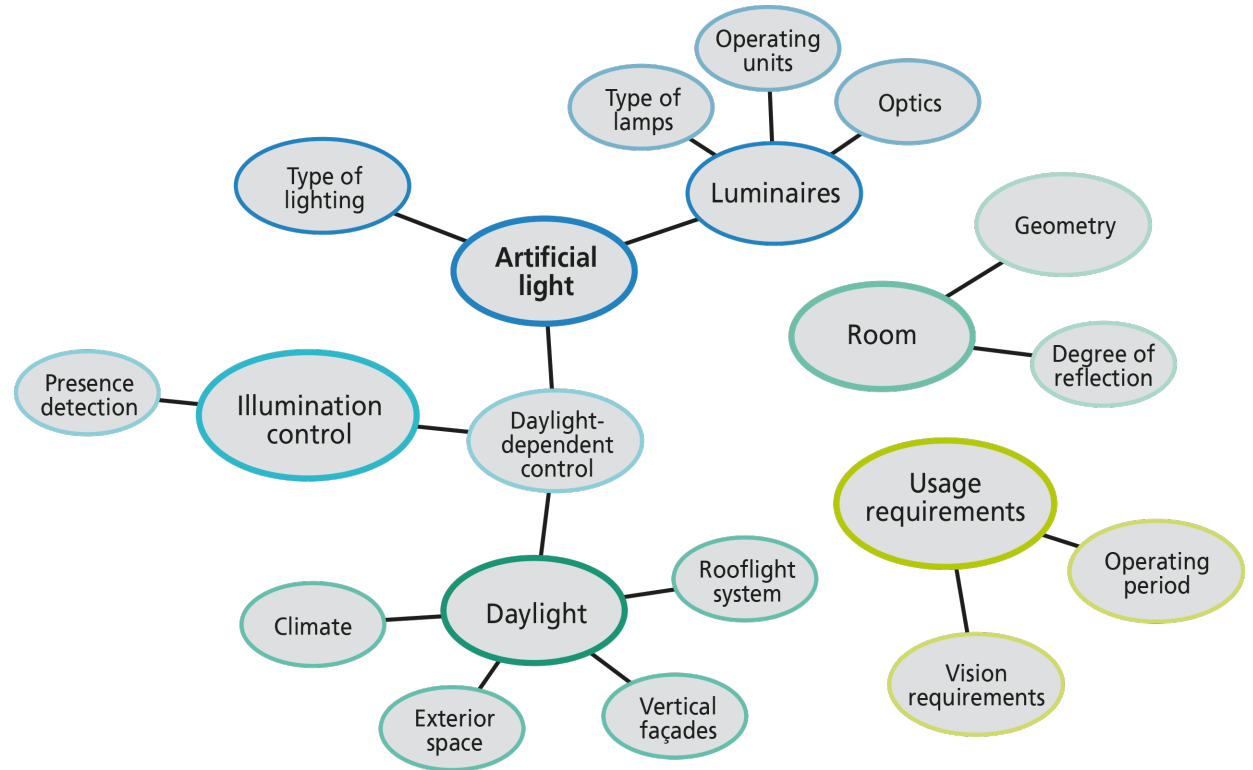

Figure 2 | Compilation of factors influencing lighting and associated energy consumption. [© Fraunhofer IBP]

Worldwide, lighting is responsible for about 15% (Fig. 1) of electricity consumption and about 5% of global CO₂ emissions. **Lighting tasks require significant resources. The optimization is worthwhile.**

In the new buildings, almost only LED systems are now being designed. The majority of existing plants, on the other hand, have not yet been converted to LED technology and hold great and often easy-to-develop climate protection potential: so-called “**Low Hanging Fruits**”. In the conversion forced by the phasing out of fluorescent lamps (e.g., in the EU this year, 2023), the main question is whether “transitional solutions” in the form of **LED replacement lamps make sense or whether it would be better to switch to more powerful LED lights right away.** However, the focus of renovations is not solely on the high efficiency of the LEDs. New control options should also be considered wherever possible in coordination with the **most sustainable light source, daylight.** In addition, the understanding of user needs has evolved in recent years [1], so that, with proper planning, renovations also ensure an **improved and performance-enhancing quality** of stay with increased visual comfort in rooms.

This **guideline** is intended to provide suggestions for accelerating the replacement of old lighting systems, harvesting the “low hanging fruits” and also taking the issue of daylight into account integrally (Fig. 2). The lighting should **be brought up to date with regard to climate protection, energy sovereignty and economic efficiency in accordance with a high level of user comfort.**

2 | How to approach a refurbishment: lamp replacement, 1:1 luminaire replacement, "deep retrofit"?

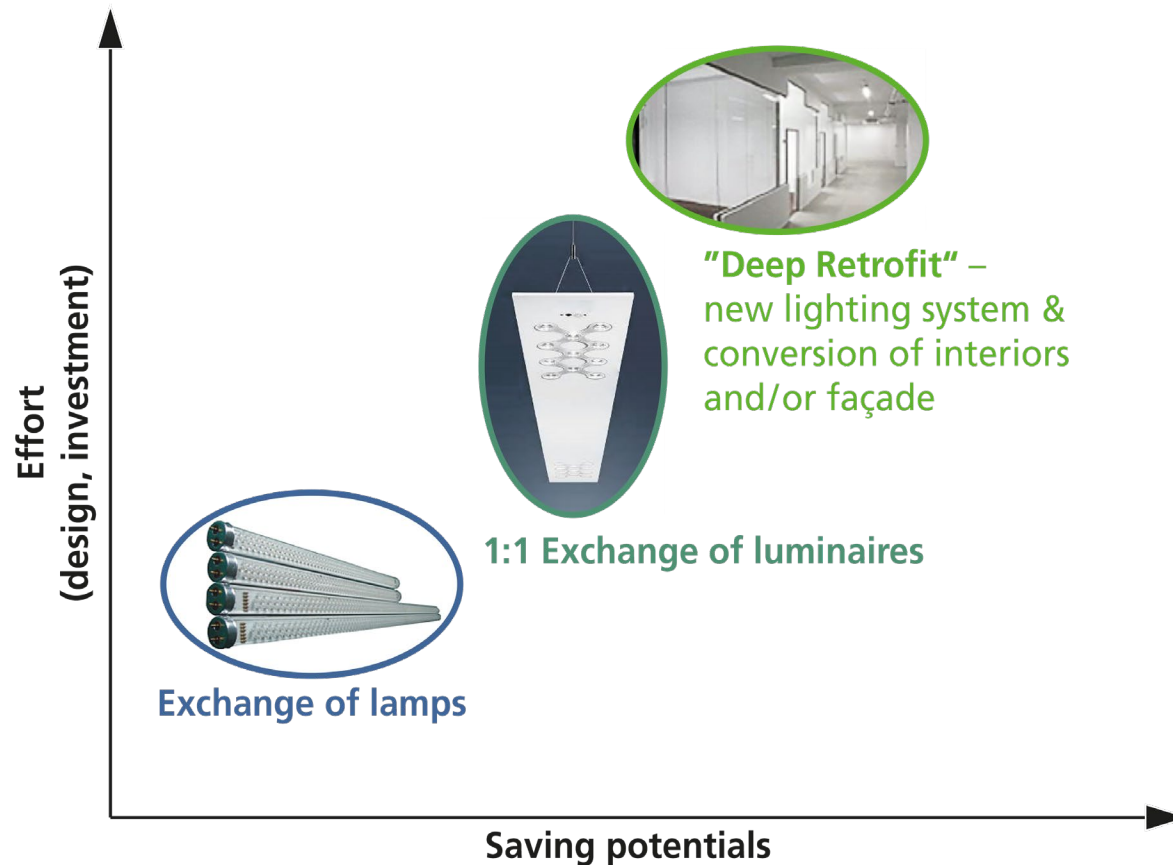

Figure 3 | Classification of retrofit measures in the field of electric lighting. [© Fraunhofer IBP]

Concrete reasons for replacing the lighting are either lighting technology that is no longer up to date or the co-renewal as an “anyway measure” in the context of major conversions, so-called “deep retrofits” (Fig. 3).

A **sole renovation of old lighting technology** can be motivated by the fact that users are dissatisfied and / or the operating costs are too high. These can be caused by the combination of inefficient luminaires with long operating times (+ higher susceptibility to maintenance). Environmental and climate protection requirements must be complied with. There are two approaches:

- **Lamp replacement:** At first glance, the simplest and supposedly cheapest measure is to replace the lamp with LED replacement products.
- **Luminaire replacement: The often more valuable alternative is the replacement of the complete luminaires. Here, the advantages of current lighting technology can be used much better, and it is generally much more efficient and economical in the medium term (Section 10).**

In the context of major renovation measures e.g., core renovation or façade renovation, all aspects of new planning apply in principle from a lighting point of view. This can also lead to a replacement of the luminaires, which is rarely the case with a pure lighting renovation. On the façade, for example, inadequate glare protection functions can be improved. As in any new planning, there are opportunities that need to be exploited and risks that need to be avoided.

3 | Why act now?

Mercury vapor lamps – Everything has to go!

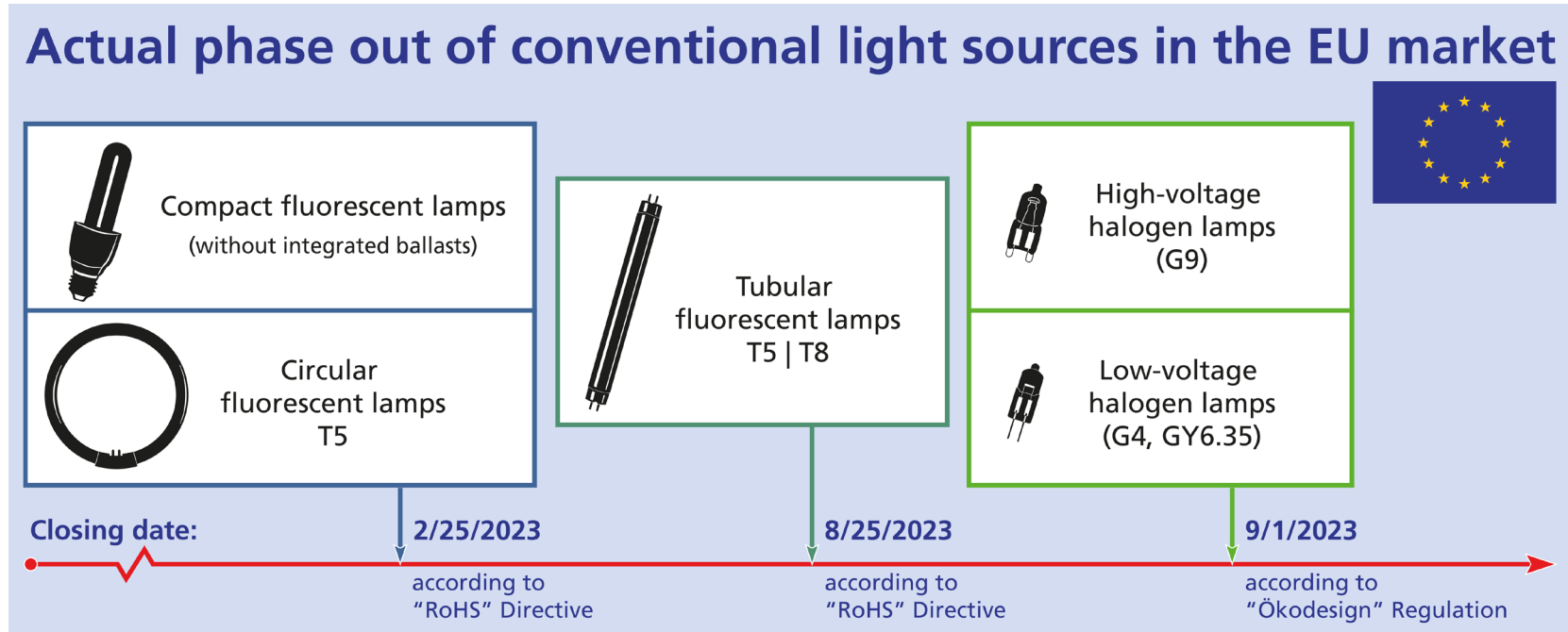

Figure 4 |
Phasing out of non-LED illuminants. [© Fraunhofer IBP]

Stockpiling lamps that are going out of the market should not be the solution:

The majority of non-LED lamps will no longer be placed on the market from this year (Fig. 4). In addition to the Ecodesign Regulation [6], which is driven by efficiency requirements, phasing out is also driven by the EU Directive on the Limitation of Hazardous Substances in Electrical and Electronic Equipment (RoHS – Restriction of the Use of Certain Hazardous Substances in Electrical and Electronic Equipment) [5].

This concerns the environmental toxin mercury, which is contained in fluorescent lamps, albeit only slightly. This means that from September 2023, almost no fluorescent lamps may be placed on the market for public purposes. This also and above all applies to the rod-shaped T8 and T5 fluorescent lamps, which are still widely used.

4 | What is the state of the art in LED technology? I/II

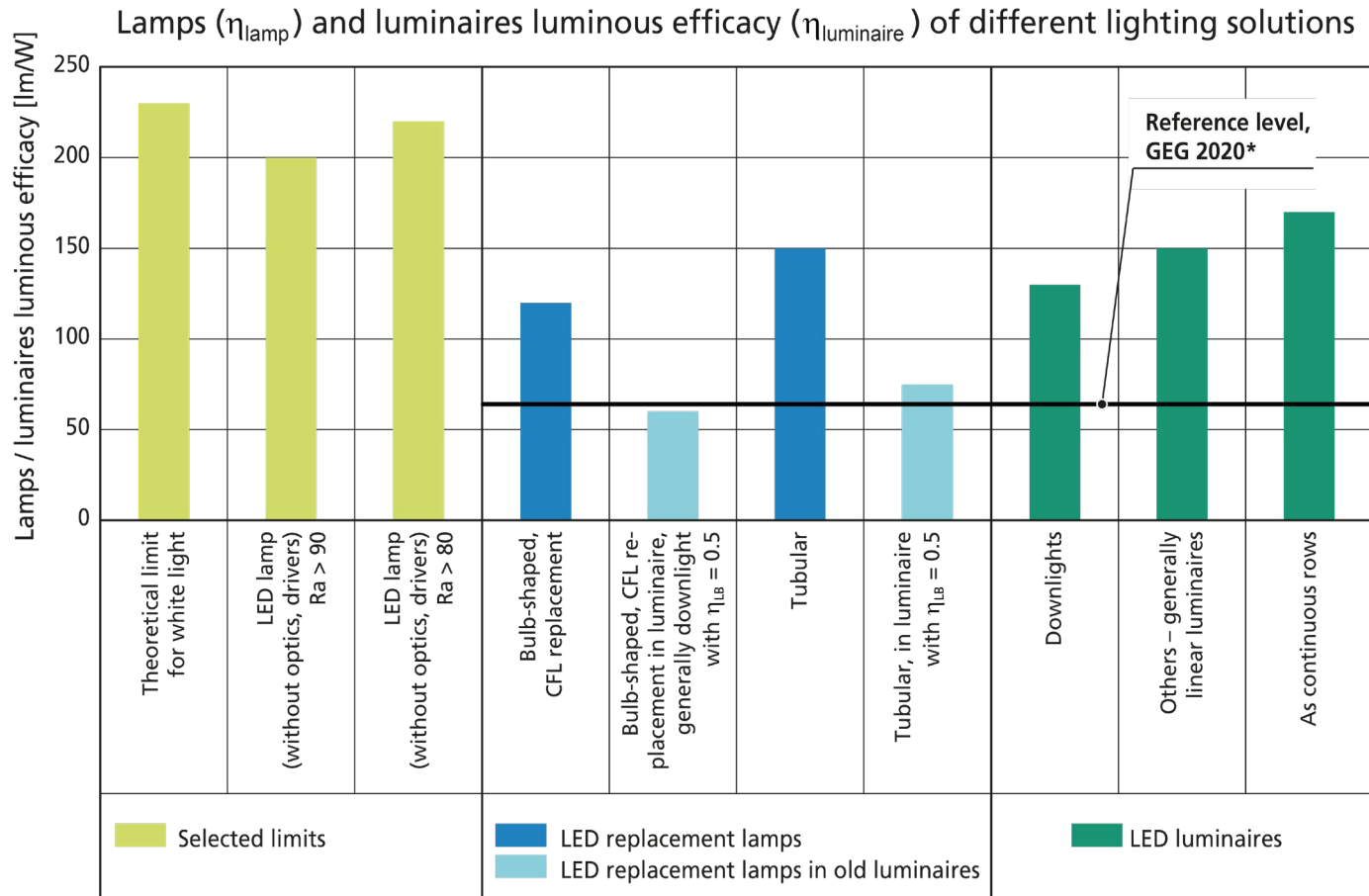

*) Tubular fluorescent lamps with EBs, direct/indirect luminaires with $\eta_{\text{LB}} = 0.8$ with an resulting luminaire luminous efficacy $\eta_{\text{luminaire}} = 64 \text{ lm/W}$

Figure 5 | Lamps and luminaires luminous efficacy of typical LED lighting solutions; Reference level of “German Gebäudeenergiegesetz GEG 2020”. [© Fraunhofer IBP]

What are the current efficiencies of LED systems?

Luminous efficiencies¹ of **LED luminaires** today (2023) are $\eta_{\text{luminaire}} = 130 - 170 \text{ lm/W}$ (Fig. 5). Differentiated by luminaire types for different applications, however, the key performance indicators vary due to different glare control requirements, color characteristics and designs. For example, the efficiencies of recessed downlights are slightly lower than those of office task lights; these, in turn, are slightly below those of continuous-row lighting systems for e.g., the lighting of halls.

LED replacement lamps for standard bases exist in numerous versions. The LED replacement products, also known as “LED tubes”, which are mainly relevant for the conversion of existing rod-shaped fluorescent lamp systems in non-residential construction, have lamp luminous efficiencies of about $\eta_{\text{lamp}} = 150 \text{ lm/W}$ and thus noticeably exceed the luminous efficiencies of previous T8 or T5 lamps. Replacement lamps for downlights are about $\eta_{\text{lamp}} = 120 \text{ lm/W}$.

It should be noted that the efficiencies of existing luminaires equipped with LED replacement lamps (low luminaire operating efficiencies!) are generally considerably lower than those of pure LED luminaires (Section 5, 6).

The limit values of maximum luminous efficacy, which are also shown on the left in Figure 5, show that LEDs are virtually “fully developed” in terms of their efficiency. It should be noted that in some countries reference levels urgently needs to be updated. As example the current level in the “German Gebäudeenergiegesetz GEG 2020” is at only $\eta_{\text{luminaire}} = 64 \text{ lm/W}$.

¹ Usable luminous flux for the electrical power used: η_{lamp} describes the luminous efficacy of the lamp only, $\eta_{\text{luminaire}}$ describes the luminous efficacy of the luminaire; therefore, it takes into account additional losses of control gear and light distribution through the luminaire optics.

4 | What is the state of the art in LED technology? II/II



Figure 6 |
“Tunable white” solutions make it possible to adjust the colour temperature e.g., in the course of the day following the daylight.
[© lumizil.de, Fraunhofer IBP]

Data transmission via lighting infrastructure – Networked systems

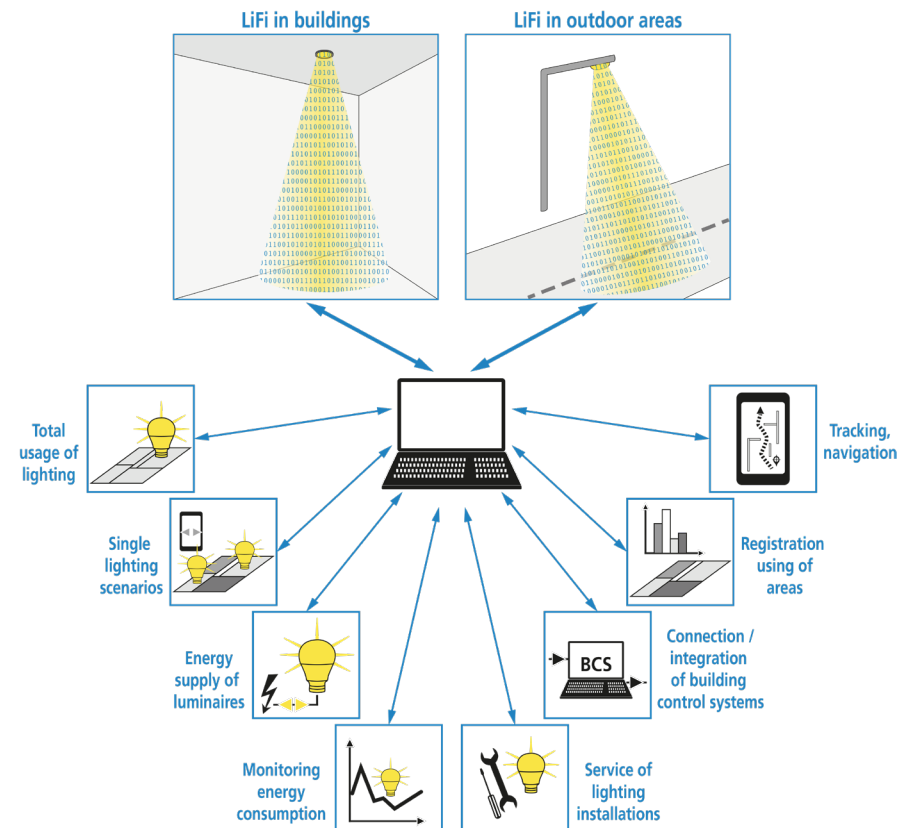

Figure 7 |
Added value of networked lighting technology that goes beyond pure lighting tasks.
[© Fraunhofer IBP]

What about the quality of LED systems today?

Problems from the introduction of LEDs, such as high “early failure rates” and “poor color binning” – resulting in perceptible colour differences in luminaires consisting of numerous individual LEDs and also between LED luminaires – are now a thing of the past for products from established manufacturers.







“More for less”, where is LED technology going?

There is a trend in the market that the LED solutions offered are increasingly providing more power and new functions. These include “tunable white” luminaires, luminaires with variable light distributions, light management integrated into the luminaires (i.e. self-sufficient luminaires without external connection to lighting control loops of the building management system) as well as the assumption of other non-lighting-specific functions (lighting as an “ICT backbone” in the ceiling) such as interior positioning with orientation functions on larger exhibition or shopping areas and also data transmission (“LiFi”). Today, the interconnection of light points forms its own information networks in space.

LED: The solution for almost every application.

There are now LED solutions for almost every lighting task. However, in applications such as halls with high temperatures, especially under the hall roof, standard LED systems cannot be used. To prevent component overheating, control gear is installed in cooler areas, separate from the LED modules. Some of the LED modules have considerably lower currents. High-pressure discharge lamps previously used in these areas are almost no longer used.

5 | LED vs. old systems: What are the “Low Hanging Fruits”?

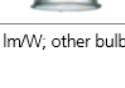
Product class to be decommissioned			Luminaire luminous efficacy					LED luminaire vs. LED retrofit
			Old system	Old system with LED retrofit*		New system with LED luminaire		
			lm/W	lm/W	Increase of efficiency (approx.)	lm/W	Increase of efficiency (approx.)	
Recessed luminaires	Halogen downlights in different types		10 – 15	70 (LED reflector lamp)	6	130	10	1.7
	Downlights based on CFL (compact fluorescent lamps)		30 – 40	60 ($\eta_{LB} = 0.5$)	1.5 – 2	130	3 – 4	2.0
	Luminaires with simple white glare protection louver with T8-, CB-lamp technology		40 – 60	75 ($\eta_{LB} = 0.5$)	1.2 – 1.5	150	2.5 – 3.5	2.2
Surface mounted luminaires	Prismatic diffuser luminaires with T8-, CB-lamp technology		ca. 40	60 ($\eta_{LB} = 0.4$)	1.5	150	3 – 4	2.3
	Opal diffuser luminaires with T8-illuminants and LLB ballasts		ca. 50	60 ($\eta_{LB} = 0.4$)	1.2	150	3	2.5
“T5-luminaires”	Screen work capable luminaires with T5-, EB-lamp technology, recess / surface / pendant		80	120 ($\eta_{LB} = 0.8$)	1.5	150	2	1.3
Row luminaires (halls)	Continuous row luminaires with T8-illuminants and CB ballasts		40 – 60	60 ($\eta_{LB} = 0.4$)	1 – 1.5	170	2 – 3	2.0
High-Bay	Luminaires in factory halls, for example mercury vapour lamps		50 – 100	No LED retrofit with equivalent luminous fluxes		170	1.5 – 3.5	-

*) Luminous efficiency retrofit lamps: tubular – 150 lm/W; other bulb-shaped, CFL replacement – 120 lm/W. Light output ratio η_{LB} in brackets. Deactivation of ballasts.

Table 1 |

Compilation of exemplary product classes for direct decommissioning with comparison of luminaire luminous efficacies and their ratios of old to new lighting installations. [Data source: Fraunhofer IBP]

TIP |

The table may serve for image matching with found luminaires.

Numerous old lighting systems can be regarded as “low hanging fruits”, for which a direct replacement would generally be worthwhile regardless of the phasing out (Section 3)². This also includes installations that are less than 10 years old. Particularly noteworthy here are systems based on T5 fluorescent lamps, which were installed just before or during the LED technology change.

An exemplary compilation of typical old luminaires can be found in Table 1. Their efficiencies (luminaire luminous efficiencies) are compared with those after a change to LEDs.

Efficiency increase factors by switching to LED replacement lamps are between 1.2 and 6, and between 1.5 and 10 when switching to LED lights. Often not the efficiency of the lamp, but the low efficiency of the luminaires is the problem. While for some types of luminaires, such as T5 luminaires with high-gloss reflector systems, the use of LED replacement lamps can noticeably increase efficiency, for other old installations, such as (yellowed) fixtures with poor efficiencies, replacing them with LED luminaires should be the method of choice.

In most cases, the actual luminaire structure in existing buildings is very different, so that a “one fits all” solution is hardly to be expected but should be renewed in a differentiated manner.

²) Influence of predefined boundary conditions such as operating times, accepted payback periods (Section 11).

6 | LED replacement lamps or LED luminaires? I/II



Figure 8 |
Selection of different designs of LED replacement lamps. [© Fraunhofer IBP]

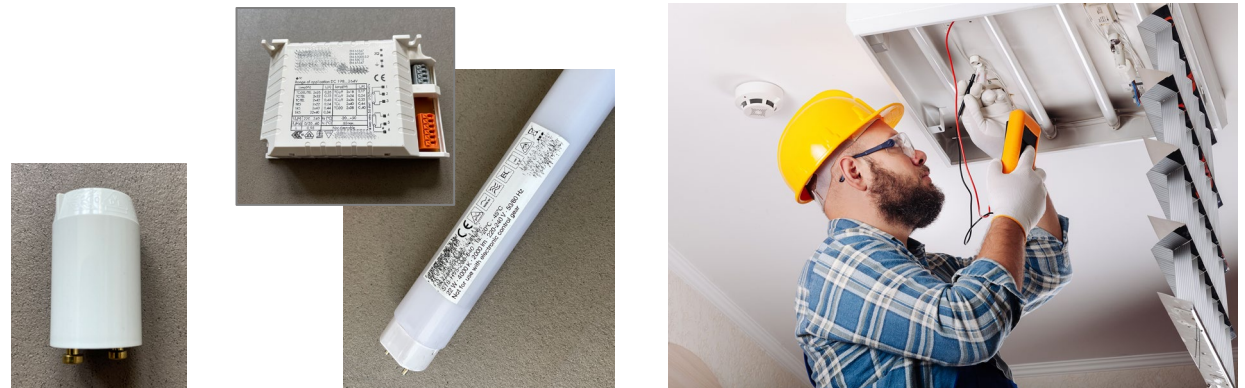

Figure 9 |
“LED starter” – electrical bridge – to replace the starter for luminaires with electromagnetic ballasts (LLB) with “retrofit lamps” (left), conversion kit to bypass the previous ballast – rewiring – (middle) [© Fraunhofer IBP] and conversion of the luminaire on the ceiling (right). [© Billion Photos / Shutterstock]

In terms of efficiency and also intrinsic value of the property, a change to pure LED luminaires is desirable, but may not always be (directly) feasible for various reasons (planning lead time, higher initial investment for LED luminaires, major renovation planned in the near future anyway ...). **LED replacement lamps offer a temporary solution.** There are numerous versions for the standard plinth (Fig. 8). With regard to the type of electrical conversion, a distinction can be made as follows.

“Retrofit lamps”, in which the luminaire is converted to LED technology without a qualified electrician. In the case of electromagnetic ballasts (Low Loss Ballast, LLB) in T8 lamps, only the starter has to be replaced by a so-called “LED starter” – an electrical bridge. This is not necessary when retrofitting luminaires with electronic ballasts (ECG) (all T5 lamps, numerous T8 lamps) that can be identified in the existing building by a flicker-free start. However, attention must be paid to the conformity of the lamp and ECG.

“Conversion lamps”, in which the electrical system of the luminaire must be changed by removing and bridging the ballast. By disabling the ballast, they are more efficient than “retrofit lamps”. The work must be carried out by a qualified electrician, to whom the warranty obligation for the electrotechnical and safety requirements of the luminaires is then transferred.

“Universal lamps” are LED lamps that can be used both as retrofit and conversion lamps.

Thus, when choosing the right LED replacement lamp, it is important to pay attention to the previous type of lamp and control gear. The providers provide comprehensive information on this e.g., on their websites, see also [8].

6 | LED replacement lamps or LED luminaires? II/II

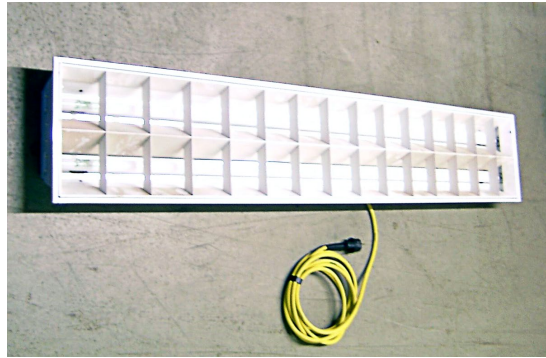

Figure 10 |
 Low efficiency of many old luminaires: luminaire operating efficiency $\eta_{LB} = 0,45$ measured on removed luminaire.
 [© Fraunhofer IBP]

Type of luminaire	Louver luminaire with fluorescent lamp	Louver luminaire with LED retrofit diffuse	Louver luminaire with LED retrofit clear

Figure 11 |
 Example of the changed light distribution when replacing fluorescent lamps with LED retrofit “LED tubulars” for an office room louver luminaire. [© Fraunhofer IBP, TRILUX]

TIP |
 Uncertainties can be eliminated by on-site sampling including measurement of the original system to be retrofitted and the same installation with LED replacement.

While the complete replacement of luminaires can be achieved by selecting suitable luminaires (coordinated luminous flux packages and luminous intensity distributions) to achieve a precise match with the previous installation and an adaptation to today's changed planning requirements, see DIN EN 12464-1 [1], this is not directly guaranteed when using LED replacement lamps. **Numerous criteria influence the subsequent quality of the converted system and should be included in the decision-making process in advance, supported by sampling:**

- **Luminous flux packages:** Many old systems per se no longer reach the previously projected values (even with new light sources) due to irreversible ageing of the luminaires (Fig. 10). Also, LED replacement lamps for example, do not achieve the high luminous fluxes of previous high-output T5 lamps.
- **Light Distribution:** Rod-shaped LED replacement lamps do not have the radially uniform radiation as fluorescent lamps. Compared to the original planning, there may be changes in light emissions (Fig. 11).
- **Nominal lifetimes:** Replacement lamps often have shorter nominal lifetimes than LED lights.
- **Dimmability:** Replacement lamps are not dimmable per se. If the old system is dimmable, specific, more expensive lamp designs must be used.
- **Cost-effectiveness: Depending on the design, rod-shaped LED lamps are about 3 – 7 €/klm (fluorescent lamps were in the range 1 – 2 €/klm), plus conversion costs. However, depending on the type of consideration (total cost of operation), LED replacement lamp solutions are less economical than converting to LED lights (Section 11).**

7 | Potentials in electric lighting – yes, of course. But what about façade and daylight?

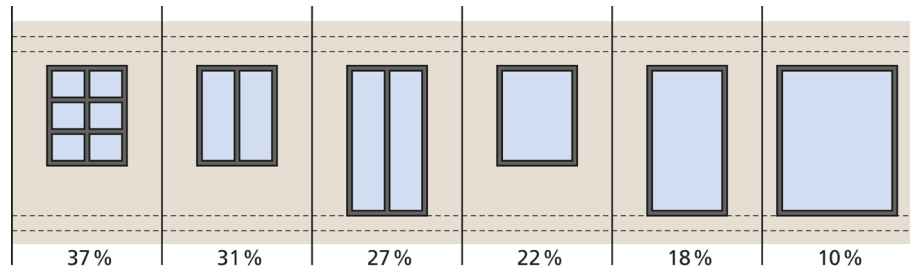

Figure 12 | Comparison of different frames with indication of the respective frame share in the clear opening. [© Fraunhofer IBP according to data from <https://www.energie.ch>]

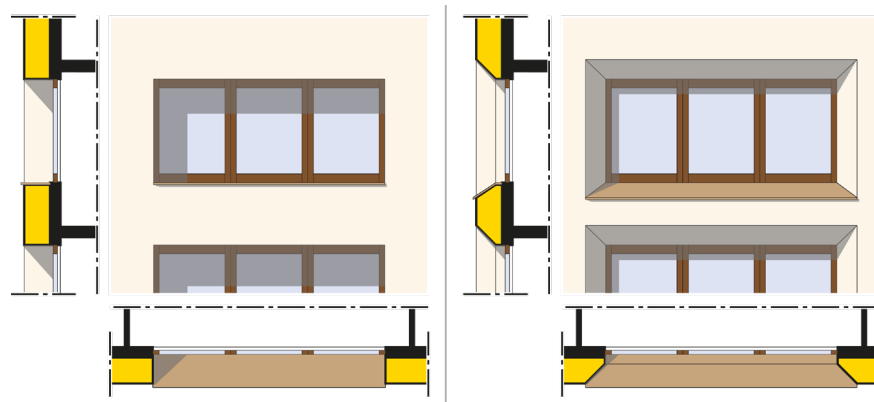
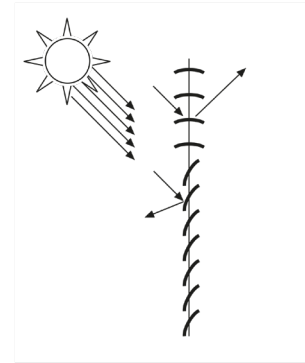
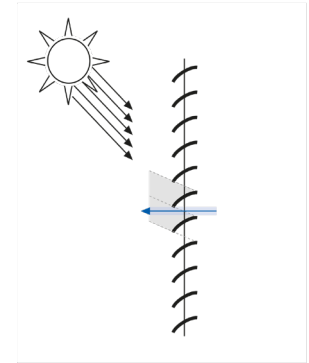

Figure 13 | Outwarded opening window reveals retain portions of previous daylighting when façade is insulated. [© Fraunhofer IBP]

Venetian blinds solution, light-directing



Venetian blinds solution, cut-off operating mode



Venetian blinds solution, retroreflective profiles

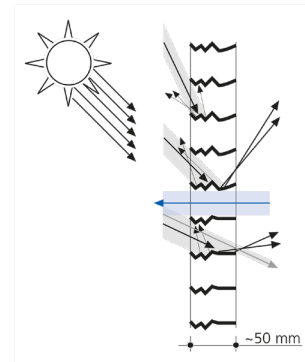

Re-directing glazing

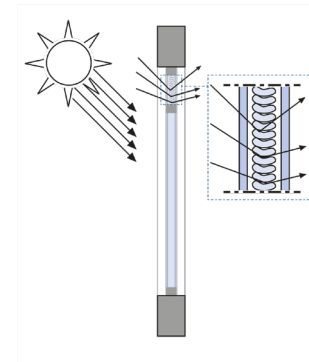

Figure 14 | Exemplary designs of light-directing sun and glare protection systems. [© Fraunhofer IBP]

Large-scale energy-efficient building renovations usually also include measures on the building envelope. Paradoxically, **the supply of daylight often deteriorates during façade renovations**, as the thermal insulation is reduced by

- multi-pane glazing systems with reduced light transmission,
- stronger frames and
- greater reveal depths due to the façade insulation.

In the sum of all effects, this can easily lead to a reduction in the daylight quotient by 30%, which corresponds to an average increase in energy consumption of about 15% and correspondingly higher CO₂ emissions for lighting.

The task of renovation should therefore be to keep the restrictions on the supply of daylight as low as possible, and if possible, even to improve them. **Possibilities of maintaining the daylight supply are shown in Figure 12 (adjustment of frame proportion), 13 (window reveals opening outwards) and 14 (light-directing sun protection systems).**

8 | What are the potentials of lighting management?

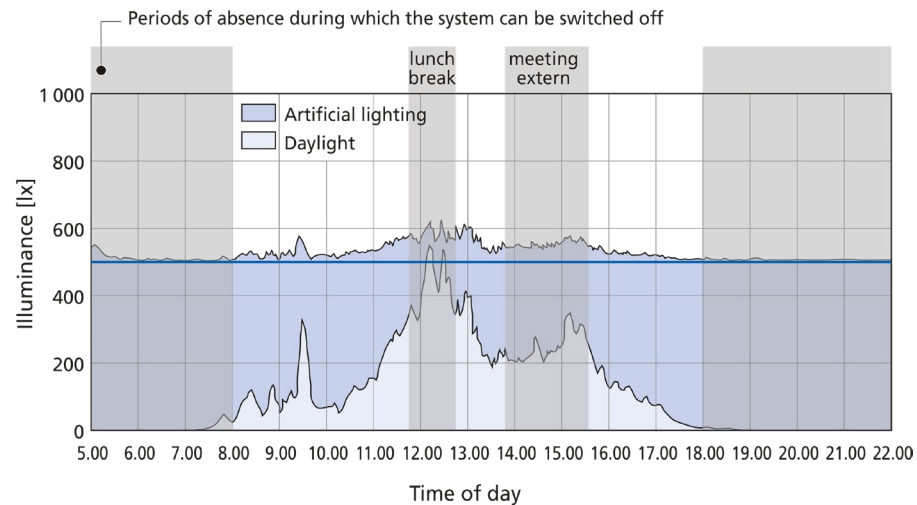

Figure 15 | Effect of daylight-dependent lighting management (real course on a winter day). Possible further savings by connected presence detection are shown. [© Fraunhofer IBP]

<p>Light control</p>	<p>Outdoor sensor, measuring head for daylight levels</p> 	<p>Interior sensor, directed to façade</p> 	
<p>Light regulation</p>	<p>Integrated sensor for daylight levels and motion</p> 	<p>Pin-up sensor</p> 	<p>Sensor technology integrated in luminaire</p> 

Figure 16 | Selected sensors for light control and light regulation. [© Fraunhofer IBP, Zumtobel, Philips, Osram, Nimbus]

Existing installations usually do not have a light management system. For new buildings, this is now in some countries anchored as a **reference technology** (e.g. the “German Gebäudeenergiegesetz”) for use cases with corresponding potential – i.e., higher absences and good daylight supply (Fig. 15 and 16). Classic functions are:

- **Presence-dependent lighting management:** opens up potentials in room areas with higher absences such as individual and group offices with absences of approx. 30% or circulation areas and sanitary rooms with approx. 80% [3].
- **Daylight management:** Due to the large variability of the influencing parameters, real measured savings potentials vary considerably (20 – 70% in documented studies). As an indication, a potential of 30% can be assumed.
- In addition to these usual controls of the electric lighting, it is advisable to include the façade. In most cases, **the control of the electric lighting and the sun and / or glare protection devices** in the façade is carried out independently of each other. **Thanks to the integrated, seasonal control of both systems, buildings can be operated more efficiently in terms of overall energy efficiency**, while at the same time maintaining a high level of user satisfaction. For example, the sun and / or glare protection can be operated according to the thermally optimal condition if the rooms are not occupied if the building management system is available, therefore:
 - Use of passive solar gains by deactivation in winter, and
 - Reduction of the risk of overheating through the best possible activation in summer.

9 | Bright rooms: friendly and very efficient!



Figure 17 | Repainting with light colour can significantly improve the lighting conditions in rooms. [© Fraunhofer IBP]





Designation		Average daylight factor [%]		
#	Type of floor plan	Dark $\rho_B=10\%$; $\rho_W=30\%$; $\rho_D=50\%$	Middle $\rho_B=20\%$; $\rho_W=50\%$; $\rho_D=70\%$	Light $\rho_B=50\%$; $\rho_W=70\%$; $\rho_D=80\%$
1	Round 	2.8	3.2	4.4
2	Oval 	2.9	3.3	4.6
3	Rectangle 	3.3	3.8	5.1
4	Star 	3.1	3.6	4.9
5	"U" 	4	4.6	6.1
6	Atrium 	4.5	5.5	7.2

Table 2 | Influence of reflectance on daylighting (daylight factor) for different floor plan types. [Data source: Fraunhofer IBP]

Dirty or dark paints have an influence on natural and artificial lighting conditions that should not be underestimated (Fig. 17).

Table 2 gives the daylight factors for low, medium and high reflectance combinations for different floor plan geometries. Light-coloured coatings have a strong positive effect on the daylight supply due to higher room efficiencies and help to reduce the installed power and thus energy consumption – while at the same time renovating the electric lighting. Of course, if the lighting system is retained, the measure will initially only result in raising the lighting level.

10 | Installation technology: How to convert efficiently? I/III

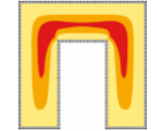
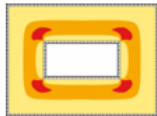
Downlight

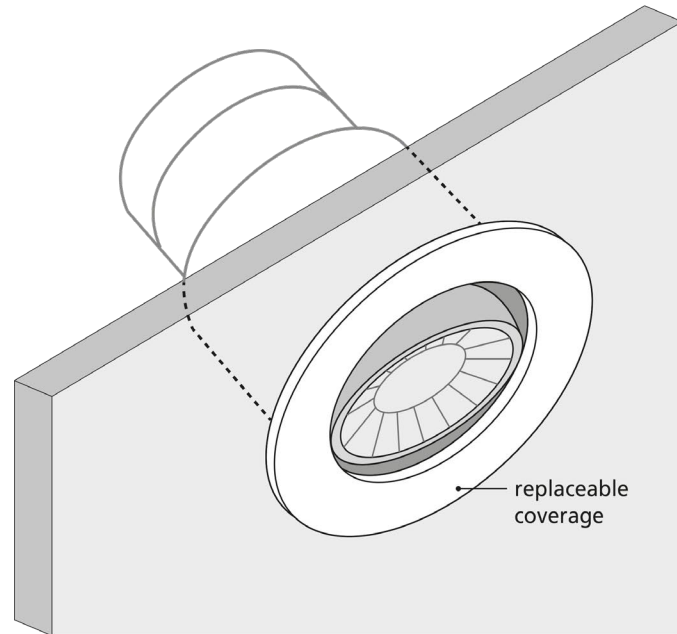

Conventional continuous row system

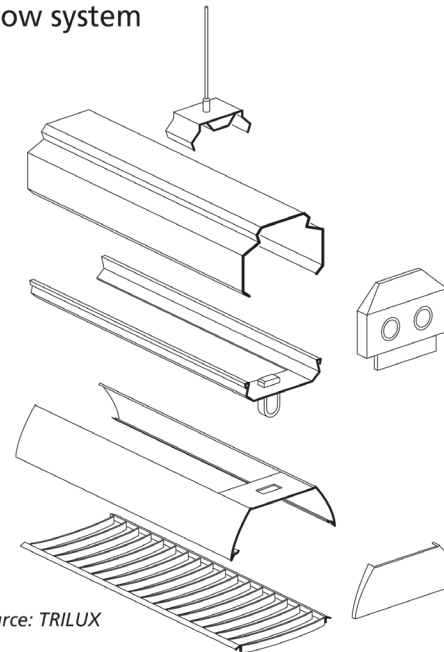

data source: TRILUX

LED continuous row system

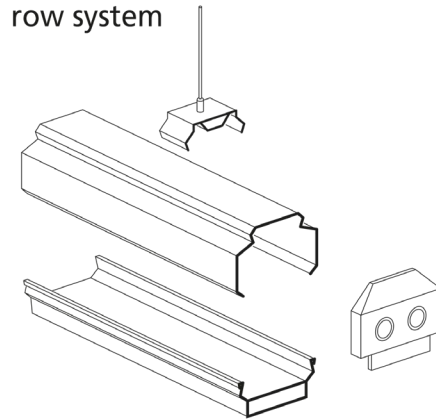



Figure 18 |

Fitting pieces for the adaption of downlight openings (left). Replacement system for luminaire heads for continuous rows (right).

[© Fraunhofer IBP according to data source TRILUX]



In addition to the pure investment costs for new lighting technology, the installation costs must be taken into account. When replacing lamps, these are limited to “retrofit lamps” purely to lamp replacement (common anyway). In the case of “conversion lamps”, the cost of the electrical conversion of the luminaire must be calculated, which may require dismantling and reassembly of the luminaires (Section 5).

In the area of “1:1 changes”, the connection points (power) are retained. In the case of recessed luminaires, substitute products of the same design can be used, such as LED recessed luminaires for standard ceiling grids. In addition, fittings are offered for the replacement of downlights with compact fluorescent lamps by LED downlights with generally smaller diameters (Fig. 18 left). It can therefore be retrofitted without costly modifications to the ceiling.

In the case of continuous-row luminaires, it is possible to replace only the luminaire head (“Light Engine”). The supporting structure and reflected ceiling plan are retained, eliminating the need for additional installation work (Fig. 18 right).

10 | Installation technology: How to convert efficiently? II/III



Figure 19 |
Compilation of the possibilities for upgrading lighting management. [© Fraunhofer IBP, Nimbus, Osram]

The retrofitting of lighting management solutions is usually more complex. Since these are rarely found in older installations, there is a lack of corresponding control cables and / or network connection points for sensors integrated in the room or façade. Possibilities are (Fig. 19):

1. Subsequent (surface-mounted) installation, usually a special solution.
2. Use of autonomously operating luminaires with already integrated sensor technology.
3. Radio-based (WLAN) technology.

Approach 1 requires a higher installation effort. Approaches 2 and 3 entail higher investment costs. Combination sensors, which check daylight availability and presence in rooms at the same time, reduce the installation effort compared to individual sensors.

10 | Installation technology: How to convert efficiently? III/III

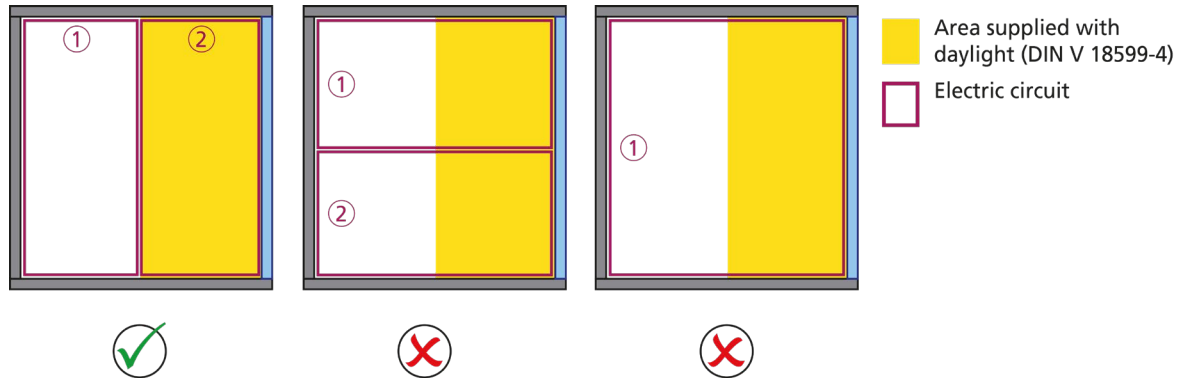

Figure 20 | Exemplary distribution of electric circuits in a situation with vertical façade, which allows a reasonable daylight-dependent control (left). Unsuitable distributions of electric circuits (middle, right). [© Fraunhofer IBP]

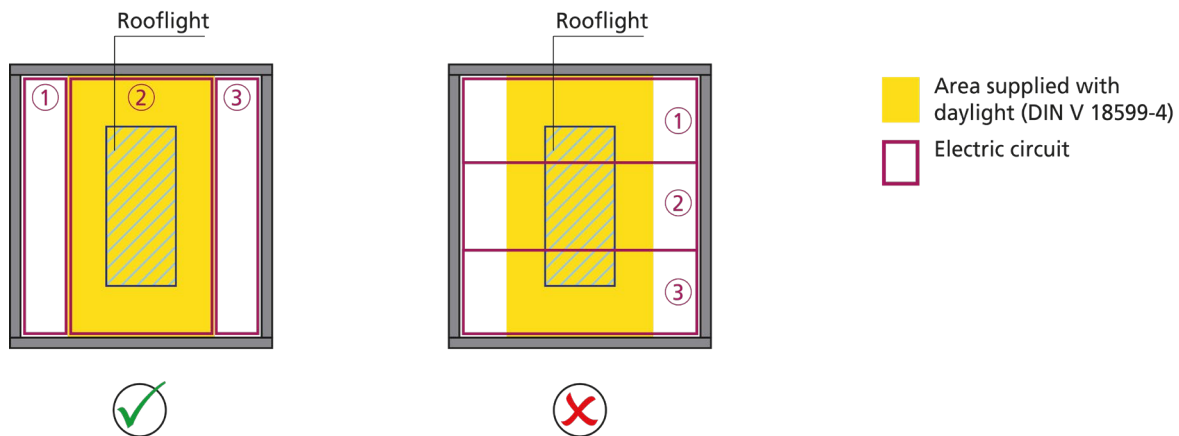



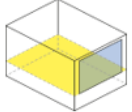
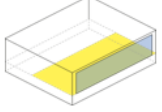
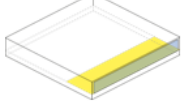

Figure 21 | Exemplary distribution of electric circuits in a larger rooflight situation, which allows a reasonable daylight-dependent control (left). Unsuitable distribution of electric circuits (right). [© Fraunhofer IBP]

The division of the circuits in larger areas of the room is often independent of the façade situation. As a result, the artificial light in areas with good daylight supply is switched according to the needs of areas with poor or no daylight supply. Potential savings by resetting or switching off artificial lighting depending on daylight are wasted.

Figure 20 and 21 each contain comparisons of daylight and non-daylight-oriented divided and switched circuits: Potential energy savings are about 30% for the roof skylight situation and about 40% for the façade situation.

The effort required to plan and implement this daylight-dependent division of the circuits is usually low but requires coordination between the architect and electrical planning.

11 | Efficiency and cost-effectiveness: “Returns in volatile times?” I/II

#	Room type (required illuminance)	Solution	Eff. Operating time	Installed power	Energy demand	CO ₂ -emission
			[h/a]	[W/m ²]	[kWh/m ² a]	[kgCO ₂ e/m ² a]
1	 Corridor (100 lx)	Old installation	500	7.5	3.8	2.1
		LED replacement lamp		3.7	1.9	1.0
		LED luminaires		1.8	0.9	0.5
		LED luminaires with LM*		1.8	0.5	0.3
2	 Single office (500 lx)	Old installation	1000	18.5	18.5	10.4
		LED replacement lamp		12.3	12.3	6.9
		LED luminaires		5.8	5.8	3.2
		LED luminaires with LM*		5.8	2.9	1.6
3	 Meeting room, laboratory (500 lx)	Old installation	1000	16.3	16.3	9.1
		LED replacement lamp		10.9	10.9	6.1
		LED luminaires		5.1	5.1	2.9
		LED luminaires with LM*		5.1	2.6	1.4
4	 Open-plan office (500 lx)	Old installation	2000	14.0	28.0	15.7
		LED replacement lamp		9.3	18.6	10.4
		LED luminaires		4.5	9.0	5.0
		LED luminaires with LM*		4.5	9.0	5.0
5	 Hall with rooflights (500 lx)	Old installation	1000	14.6	14.6	8.2
		LED replacement lamp		9.7	9.7	5.4
		LED luminaires		5.1	5.1	2.9
		LED luminaires with LM*		5.1	2.6	1.4
6	 Hall without rooflights (500 lx)	Old installation	2000	14.6	29.2	16.4
		LED replacement lamp		9.7	19.4	10.9
		LED luminaires		5.1	10.2	5.7
		LED luminaires with LM*		5.1	10.2	5.7

*) LM: Lighting management

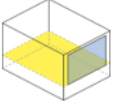
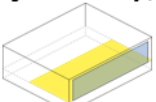
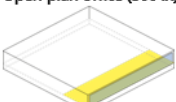

Table 3 | Energy and emission (for CO₂ emission factors of 0.56 kgCO₂e/kWh) characteristics of exemplary room types. [Data source: Fraunhofer IBP]



The lighting power consumption to be paid depends on the interaction of the times and requirements of use, the electric lighting, the daylight input via the façade, the light management and room parameters (Fig. 2). For selected type rooms, Table 3 contains energy requirements determined from annual operating times and usual installed capacities in accordance with DIN V 18599-4 [2]. The CO₂ footprint of the operating phase can then be estimated for corresponding CO₂ emission factors (e.g., 0.56 kgCO₂e/kWh to be applied in Germany). “Embodied carbon”, the “grey energy bound in the product”, is generally less than 10% of CO₂ emissions during the operating phase for lighting installations.

For example, the expenditure on energy and CO₂ emissions follows the efficiency of the electric lighting described above (section 4 and 5) on the one hand and the daylight supply on the other. With a good supply of daylight, daylight-dependent light management enables energy savings of over 40% compared to manual switching. The positive influence of the use of daylight is particularly evident in the comparison of the two halls (room type #5 and #6).

11 | Efficiency and cost-effectiveness: “Returns in volatile times?” II/II

#	Room type (required illuminance)	Solution	Typical Investment	Energy costs, year 1 / year 20	Amortization	Total costs 20 years
			[€/m ²]	[€/m ²]	[a]	[€/m ²]
1	 Corridor (100 lx)	Old installation	-	1.1 / 2	-	37
		LED replacement lamp	3	0.6 / 1	7.5	23
		LED luminaires	21	0.3 / 0.5	16	33
		LED luminaires with LM*	24	0.2 / 0.3	16	33
2	 Single office (500 lx)	Old installation	-	5.6 / 9.7	-	153
		LED replacement lamp	8	3.7 / 6.5	4.5	112
		LED luminaires	51	1.7 / 3	12	102
		LED luminaires with LM*	60	0.9 / 1.5	11.5	88
3	 Meeting room, laboratory (500 lx)	Old installation	-	4.9 / 8.6	-	135
		LED replacement lamp	7	3.3 / 5.7	5	100
		LED luminaires	45	1.5 / 2.7	12	91
		LED luminaires with LM*	53	0.8 / 1.3	11.5	78
4	 Open-plan office (500 lx)	Old installation	-	8.4 / 14.7	-	227
		LED replacement lamp	6	5.6 / 9.8	2	161
		LED luminaires	39	2.7 / 4.7	10	116
		LED luminaires with LM*	45	3.6 / 6.3	11.5	122
5	 Hall with rooflights (500 lx)	Old installation	-	4.4 / 7.7	-	122
		LED replacement lamp	6	2.9 / 5.1	5	89
		LED luminaires	41	1.5 / 2.7	12	87
		LED luminaires with LM*	47	0.8 / 1.3	12.5	72
6	 Hall without rooflights (500 lx)	Old installation	-	8.8 / 15.4	-	236
		LED replacement lamp	6	5.8 / 10.2	2	167
		LED luminaires	41	3.1 / 5.4	7	128

*) LM: Lighting management

Table 4 | Exemplary, aggregated economic parameters of different room types. [Data source: Fraunhofer IBP]

Based on the energy requirements, Table 4 continues the evaluation of the type rooms with regard to the economic efficiency³ of different renovation solutions.

LED replacement lamps pay for themselves in the short term and faster than a change to LED lights.

- However, switching to LED luminaires over longer periods of time is more economical due to their sometimes-higher efficiency and thus significantly lower operating costs. In addition, with proper planning, there is a better quality of light while complying with current specifications such as DIN EN 12464 [1].
- Light management (LM), which uses good daylight supply (room type #2, #5) and activates the systems only when the users are present, should generally be configured. This pays off in the medium term. In uses with low daylight supply, such as open-plan offices (room type #4) or large-scale (test) halls without skylights (room type #6), the potentials are lower; however, possibly more frequent absences of users can be exploited energetically by presence-dependent regulations.

³) The considerations are based on an electricity price of 0.30 €/kWh and an annual price increase of 3%. Based on assumed investments [4] and the annual energy costs, the payback period and total costs of operating the plants (“TCO: Total Cost of Ownership”) for a period of 20 years are given.

12 | What financing and funding opportunities are available?



[© Denphumi / Shutterstock]

Financing energy efficiency and climate change mitigation

Legal requirements (like “EnSimiMaV” in Germany) and also company specific resolutions require the rapid implementation of measures to improve energy efficiency and reduce greenhouse gas emissions. To support this transition several governmental programmes are offering financial support for economic energy efficiency and climate protection measures. Detailed information on available programmes (financing conditions, application, etc.) can generally be found on the web, for instance on sites of energy agencies.

External financing in the form of contracting (ESPC - Energy Saving Performance Contract) and leasing of systems is also increasingly being used in the lighting sector [9]. LED technology with longer-lasting products and greater savings potential compared to previously used technology makes these business models more attractive for both service providers and users of the lighting system.

References

- [1] DIN EN 12464-1: Light and lighting – Lighting of workplaces – Part 1: Indoor workplaces.
- [2] DIN V 18599-4: Energy efficiency of buildings – Calculation of the net, final and primary energy demand for heating, cooling, ventilation, domestic hot water and lighting – Part 4: Net and final energy demand for lighting.
- [3] DIN V 18599-10: Energy efficiency of buildings – Calculation of the net, final and primary energy demand for heating, cooling, ventilation, domestic hot water and lighting – Part 10: Boundary conditions of use, climatic data.
- [4] Fontoynt, M.; de Boer, J.; Röklander, J.; Guldhammer, K.: Global Economic Models. Technical Report T50.A1 of IEA-SHC Task 50 “Advanced Lighting Solutions for Retrofitting Buildings” (5/2016). Costs adjusted to cost development of lighting products until 2023.
- [5] <https://environment.ec.europa.eu/topics/waste-and-recycling/rohs-directive>.
- [6] Commission Regulation (EU) 2019/2020 of 1 October 2019 for determination of ecodesign requirements for light sources and separate control gear.
- [7] ZVEI-compendium: “Planungssicherheit in der LED-Beleuchtung. Begriffe, Definitionen und Messverfahren“. 3rd Edition, March 2020. ZVEI Fachverband Licht, Frankfurt (https://www.zvei.org/fileadmin/user_upload/Presse_und_Medien/Publikationen/2020/Maerz/Leitfaden_Planungssicherheit_in_der_LED-Beleuchtung_3.Ausgabe/ZVEI_Leitfaden_Planungssicherheit_LED-Beleuchtung_-_3._Ausgabe-2020-03.pdf).
- [8] ZVEI-VDE-information: “Hinweise zum Einsatz von LED-Lampen als Alternative zu zweiseitig gesockelten Leuchtstofflampen in Leuchten“. October 2020. ZVEI Fachverband Licht, Frankfurt (<https://www.zvei.org/presse-medien/publikationen/hinweise-zum-einsatz-von-led-lampen-als-alternative-zu-zweiseitig-gesockelten-leuchtstofflampen-in-leuchten>).
- [9] Fontoynt, M. et. al.: Proposal of Actions Concerning the Value Chain. Technical Report T50.A3 of IEA-SHC Task 50 “Advanced Lighting Solutions for Retrofitting Buildings” (5/2016).

APPENDIX

Investment margin estimation tool I/IV

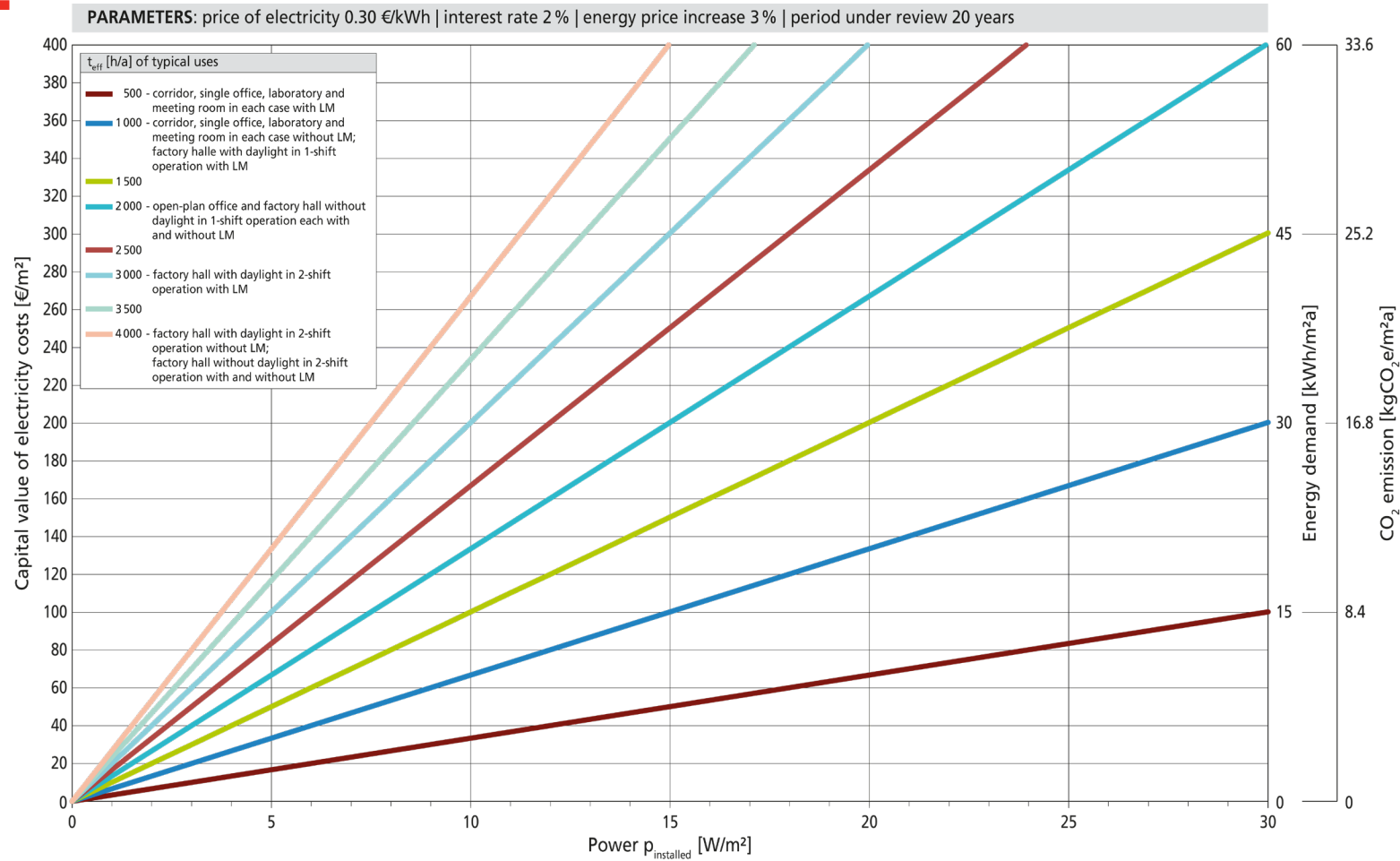

Figure A.1 | Capital value of electricity costs, energy demand and CO_2 emission as a function of installed power and operating time. [© Fraunhofer IBP]

This annex contains an estimation aid for the scope for investment in the renewal of lighting systems. Based on the estimated sum

- a) a decision is made as to whether a measure is potentially economical, and
- b) if necessary, a comparison with an offer from a specialist electrician can be made as a result.

The expenditure (net present value) for energy is determined as a function of the installed power and the effective operating time of the lighting system. In terms of operating costs, energy costs generally outweigh other maintenance costs significantly, so that the scope for investment can be estimated approximated by the discounted energy costs. At the same time, the expected final energy demand and CO₂ emissions are determined. An electricity price of 0.30 €/kWh, an interest rate of 2%, an inflation rate of 3% and an observation period of 20 years are applied.

The following pages contain:

- notes on determining the installed capacity and operating times,
- an example, and
- a table form to assist with an inspection.

Investment margin estimation tool II/IV

#	Typical uses / zone	Lighting management	t_{eff} [h/a]
1	Corridor	with	500
		without	1000
2	Single office	with	500
		without	1000
3	Laboratory	with	500
		without	1000
4	Meeting room	with	500
		without	1000
5	Open-plan office	with	2000
		without	2000
6	Factory hall with daylight (1-shift operation)	with	1000
		without	2000
7	Factory hall without daylight (1-shift operation)	with	2000
		without	2000
8	Factory hall with daylight (2-shift operation)	with	3000
		without	4000
9	Factory hall without daylight (2-shift operation)	with	4000
		without	4000

Table A.1 | Operating times of typical uses with and without lighting management.

Type of lamps	Factor k_{EG}	
Low voltage halogen lamps with transformer	1.1	
Fluorescent lamps (tubular or compact)	with EB	1.1
	with CB	1.3
High-pressure metal halogen vapour lamps* with CB	1.1	
High-pressure sodium vapour lamps* with CB	1.1	
High-pressure mercury vapour lamps* with CB	1.1	

*) For high-pressure lamps with EB, check with the manufacturer for system performance.

Table A.2 | Correction factors, operating devices.



Figure A.2 | Imprinted lamp power of 58 W. [© Fraunhofer IBP]

Typical operating hours can be found in Table A.1. In the case of new luminaires (LED luminaires), the installed electrical power $p_{\text{installed}}$ is indicated as the system power of the entire luminaire unit. In the case of older luminaires, this is generally not indicated, but can usually be easily determined via the performance of the lamp and correction factors of the control gear (ballasts) [2].

For a quick and simplified determination of the total power, the respective lamp power to be read on site can be multiplied by the factors k_{BG} given in Table A.2. The lamp power is generally printed on the lamps (Fig. A.2) or indicated on the luminaires. k_{BG} maps the additional power consumption by the control gear. As an example, this results in an installed power for a luminaire with the rod-shaped fluorescent lamp in Figure A.2 of $p_{\text{installed}} = 58 \text{ W} \times 1,3 = 75 \text{ W}$. The measurement of the system performance (specialist!) is also possible. It is also possible to measure the entire installed capacity of an area to be evaluated.

The specific, area-related, installed power $p_{\text{specific, installed}}$ for lighting for a viewing area then results in:

$$p_{\text{specific, installed}} = \frac{P_{\text{installed}}}{A} \quad \text{with}$$

$P_{\text{installed}}$: the sum of the system outputs of all luminaires in the calculation range in W,

A: the area of the observation area in m^2 .

As an example, for an open-plan office with 24 luminaires, each with a 58 W T8 lamp, with LLB on a room area of 90 m^2 , the following specific installed power results in: $p_{\text{specific, installed}} = 24 \times 58 \text{ W} \times 1,3 / 90 \text{ m}^2 = 20,1 \text{ W/m}^2$.

Investment margin estimation tool III/IV

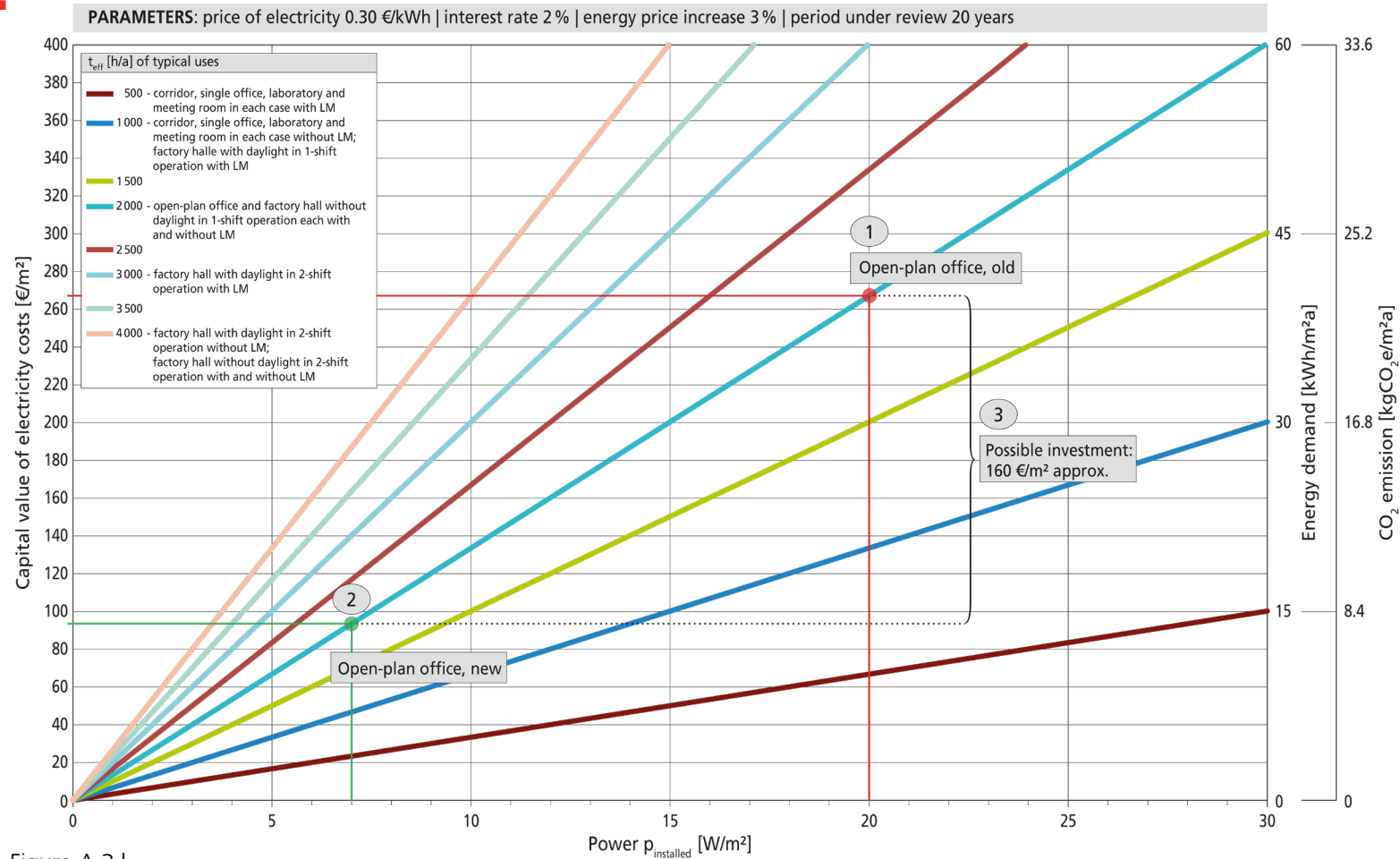

Figure A.3 | Example application of the estimation tool. Shown are the three steps to approximate a possible investment for an open-plan office situation. © Fraunhofer IBP

Figure A.3 shows the three steps required to approximate a possible scope for investment in an open-plan office.

1. The area-related installed capacity before the renovation was determined to be 20 W/m² (see slide 44), assuming an operating time of 2000 hours (Table A.1).
2. After replacing the luminaires, this drops to 7 W/m², with an unchanged operating time of 2000 hours. The area-related, installed power of new LED luminaires of 7 W/m² can be estimated from Section 5: Efficiency increase factor 3 when replacing recessed luminaires, T8, LLB with corresponding LED luminaires.
3. The difference between the net present values of 1 and 2 results in the investment leeway of around 160 €/m².

Usual investments for the re-equipping of open-plan offices with LED luminaires are in the range of 40 – 50 €/m² (Section 10). The measure would therefore be economical.

Investment margin estimation tool IV/IV

#	Room / zone	Annual operating time	Estimated installed power		Energy demand		CO ₂ emission		Capital value expenses for energy		
			Old installation	New installation	Old installation	New installation	Old installation	New installation	Old installation	New installation	Difference, therefore possible investment
		[h]	[W/m ²]		[kWh/m ² a]		[kgCO ₂ e/m ²]		[€/m ²]		
1	<i>Open-plan office</i>	<i>2000</i>	<i>20</i>	<i>7</i>	<i>40</i>	<i>14</i>	<i>22.4</i>	<i>7.8</i>	<i>270</i>	<i>110</i>	<i>160</i>
2											
3											
4											
5											
6											
7											
8											
9											
10											

Table A.3 | Spreadsheet form for determining the investment margin. Values of the example in this appendix (page 45) are pre-entered.

Table A.3 can be used to document the potentials of a property consisting of several rooms. The table is also available as an Excel spreadsheet on the IEA SHC website.

The Solar Heating and Cooling Technology Collaboration Programme (SHC TCP) was established in 1977, one of the first programmes of the International Energy Agency. The SHC TCP's work is unique in that it is accomplished through the international collaborative effort of experts from country members, sponsor members and the European Union.

www.iea-shc.org