

Examples of solar cooling innovations in SHC Task 53

Pedro V. Quiles

Universidad Miguel Hernández de Elche

pedro.vicente@umh.es

<http://dime.umh.e>

Francisco J. Aguilar Valero

Universidad Miguel Hernández de Elche

Simón Aledo Vives

simon@prointer.es

Prointer, S.L.



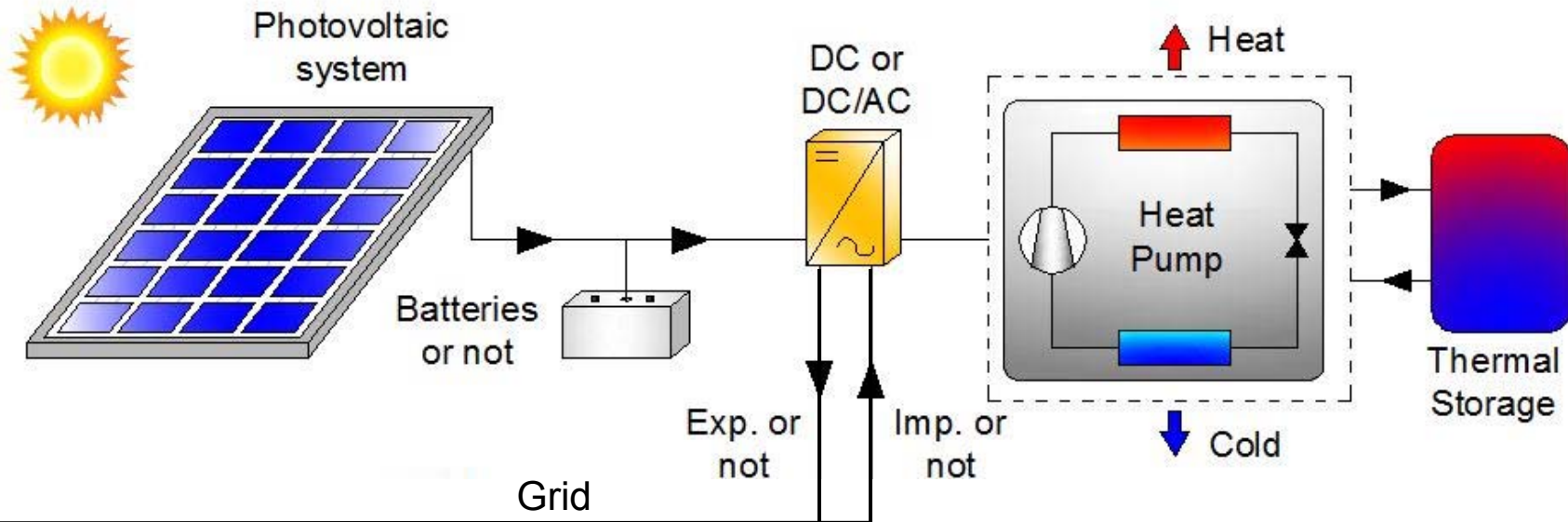

DESING CHARACTERISTICS

- **ELECTRICITY EXPORT: YES/NO**
- **BATTERIES: YES/NO**
- **THERMAL STORAGE: YES/NO**
- **COMPRESOR: INVERTER, W=CONSTANT**
- **IMPROVED CONTROL (SOLAR)**

DIMENSIONS:

- **NUMBER OF PV PANELS**
- **COMPRESOR POWER**
- **BATTERIES: Ah**
- **STORAGE CAPACITY**

GENERAL APPROACH

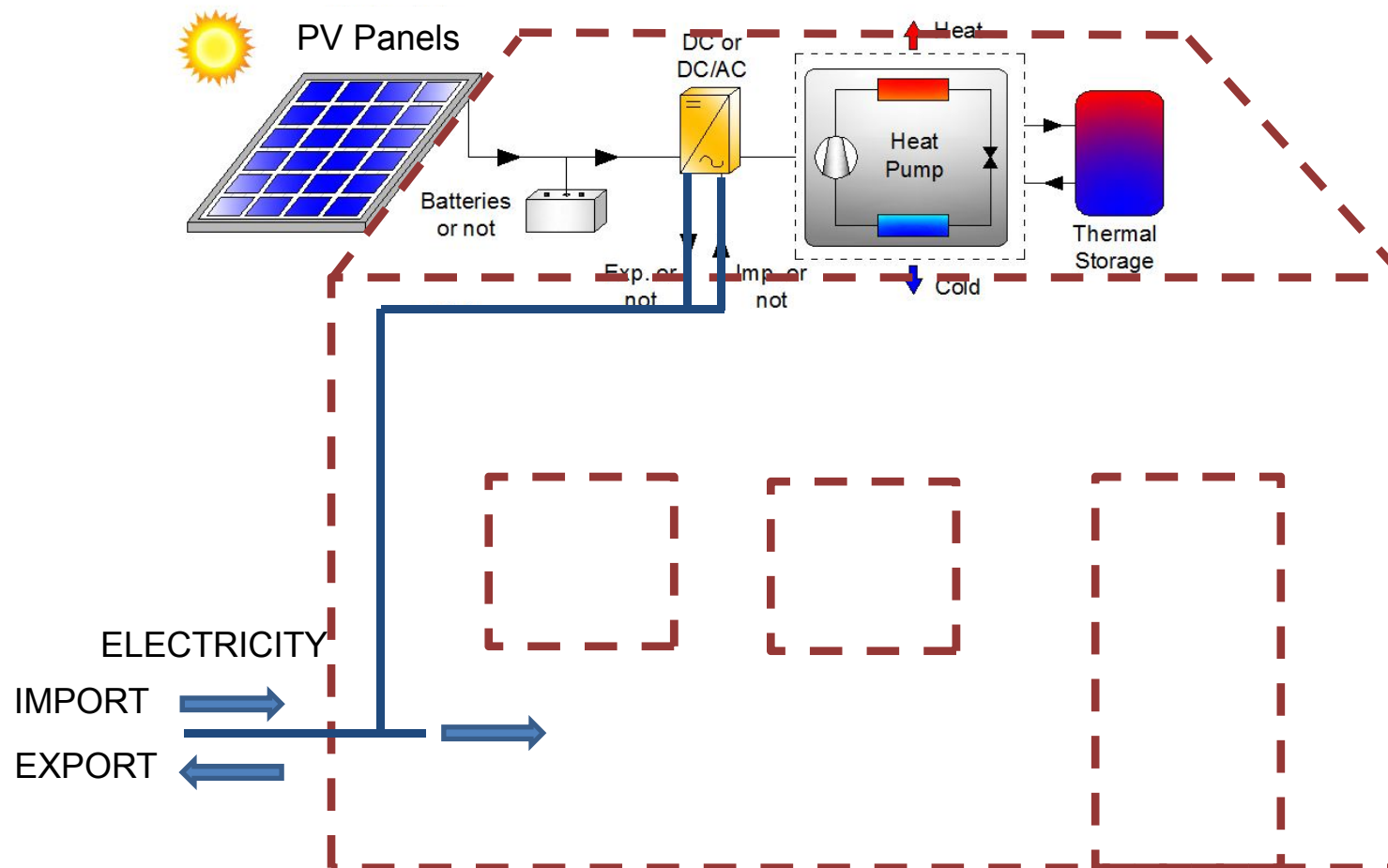

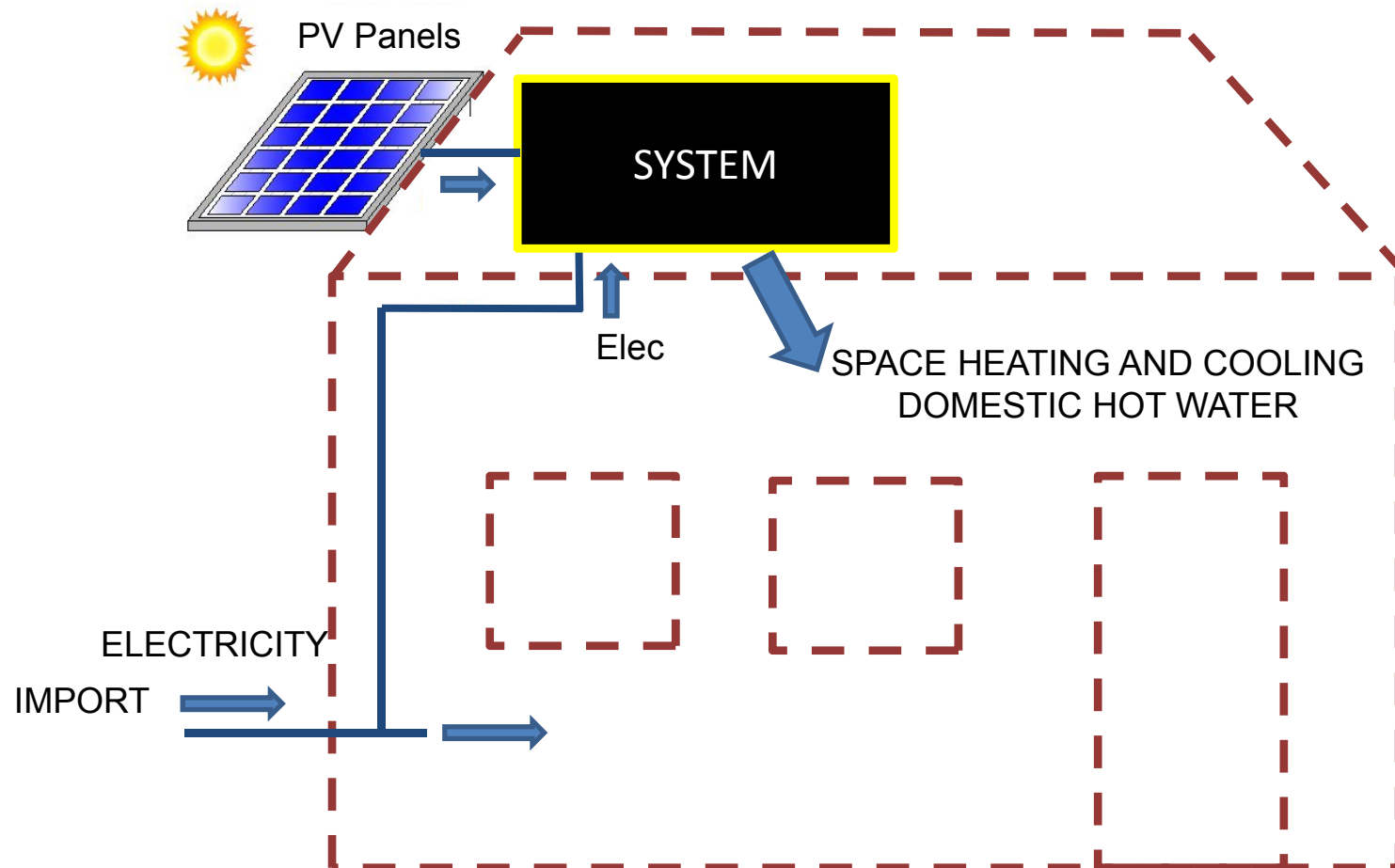

SOLAR AIRCONDITIONERS

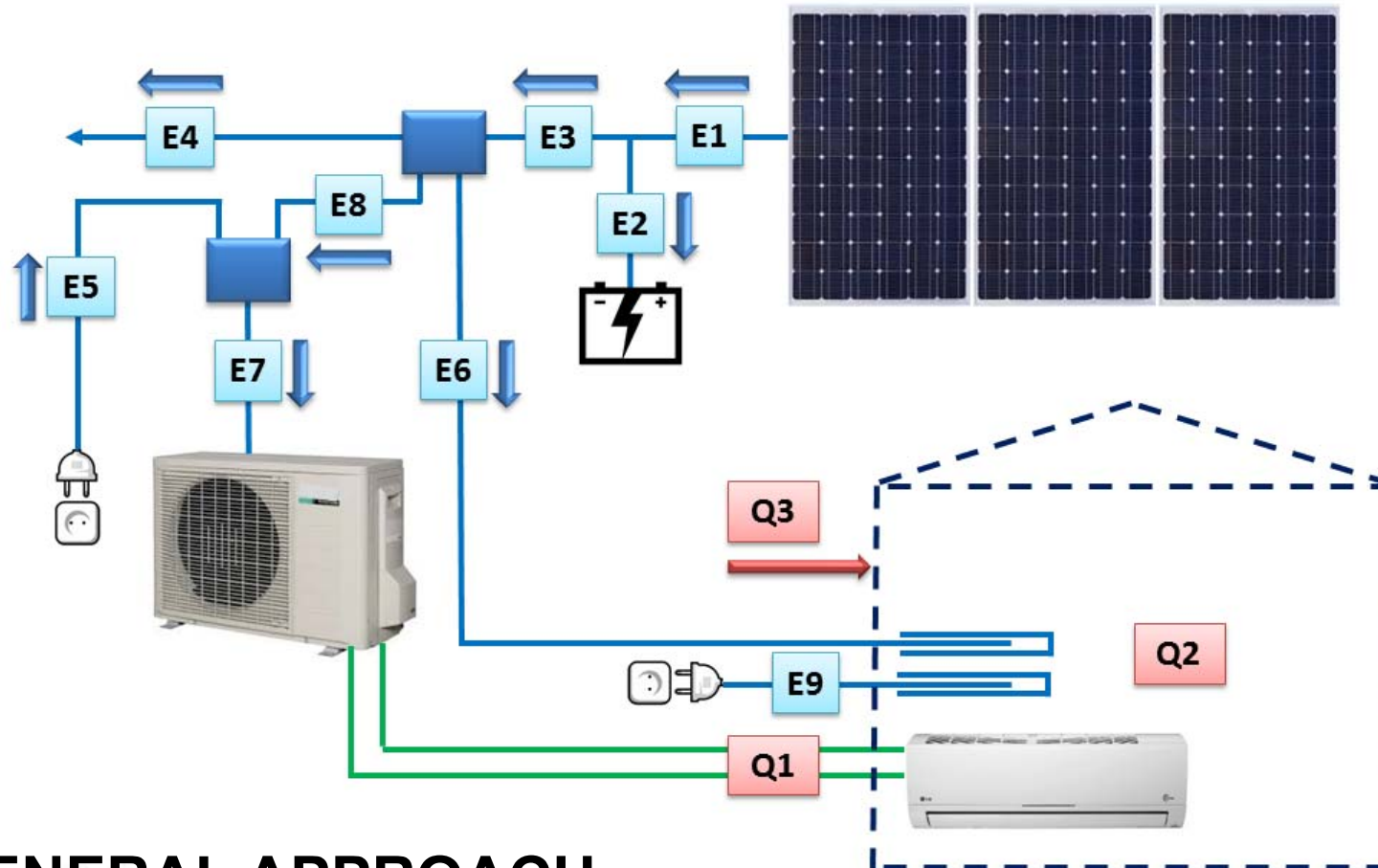

GENERAL APPROACH

SOLAR AIRCONDITIONERS

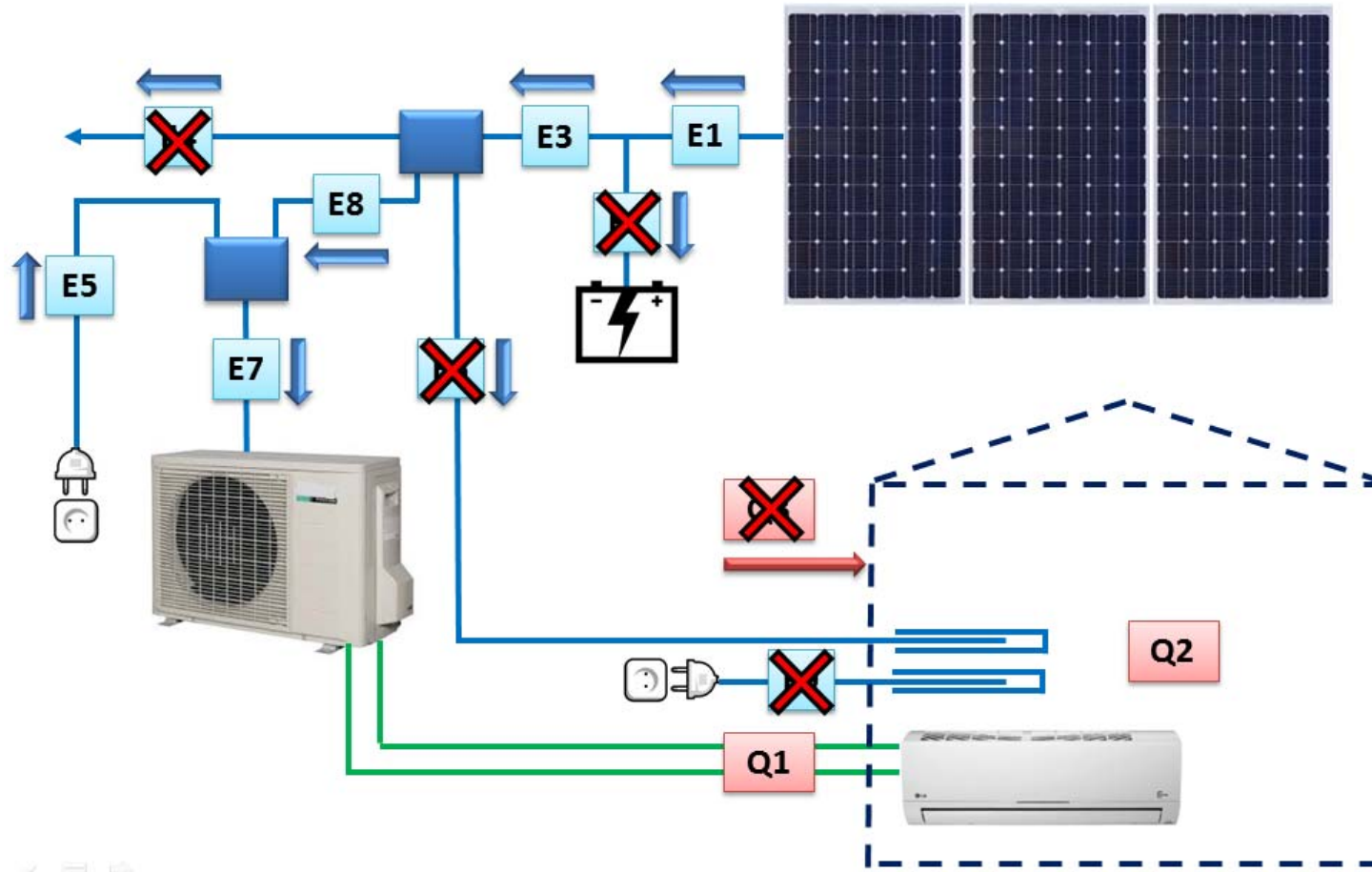

SOLAR AIRCONDITIONERS

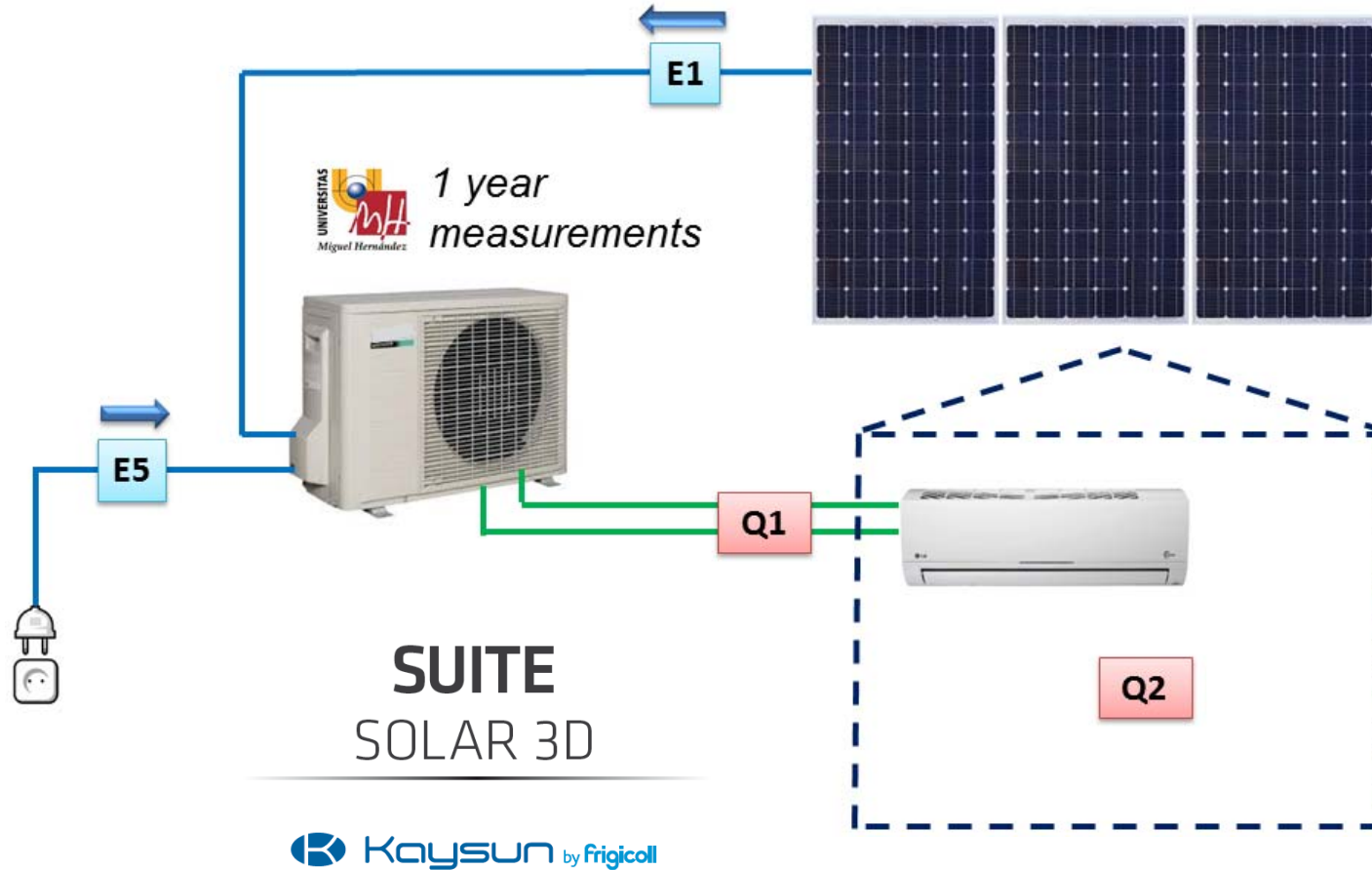

INSTALLATION

Cables connection

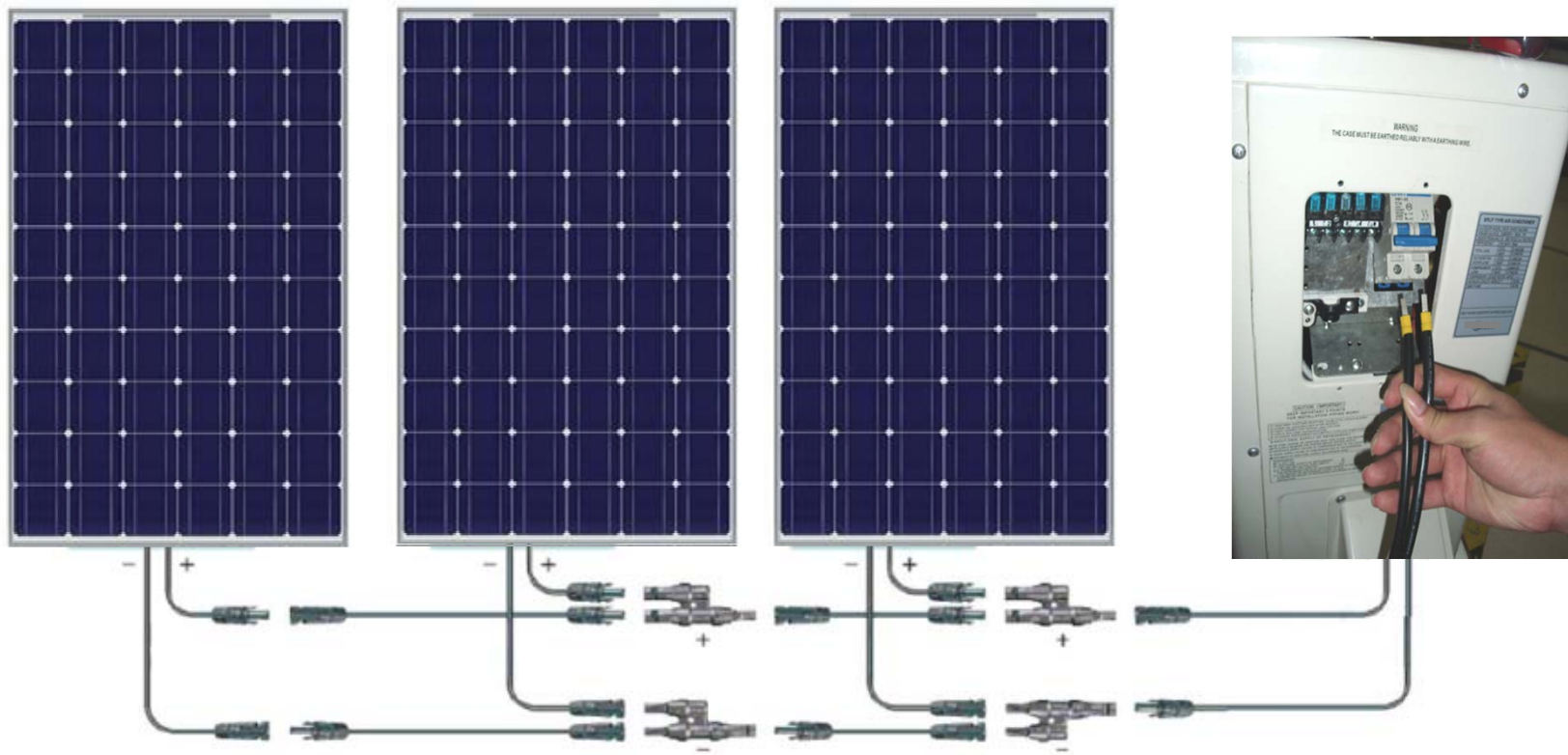

ELECTRONICS







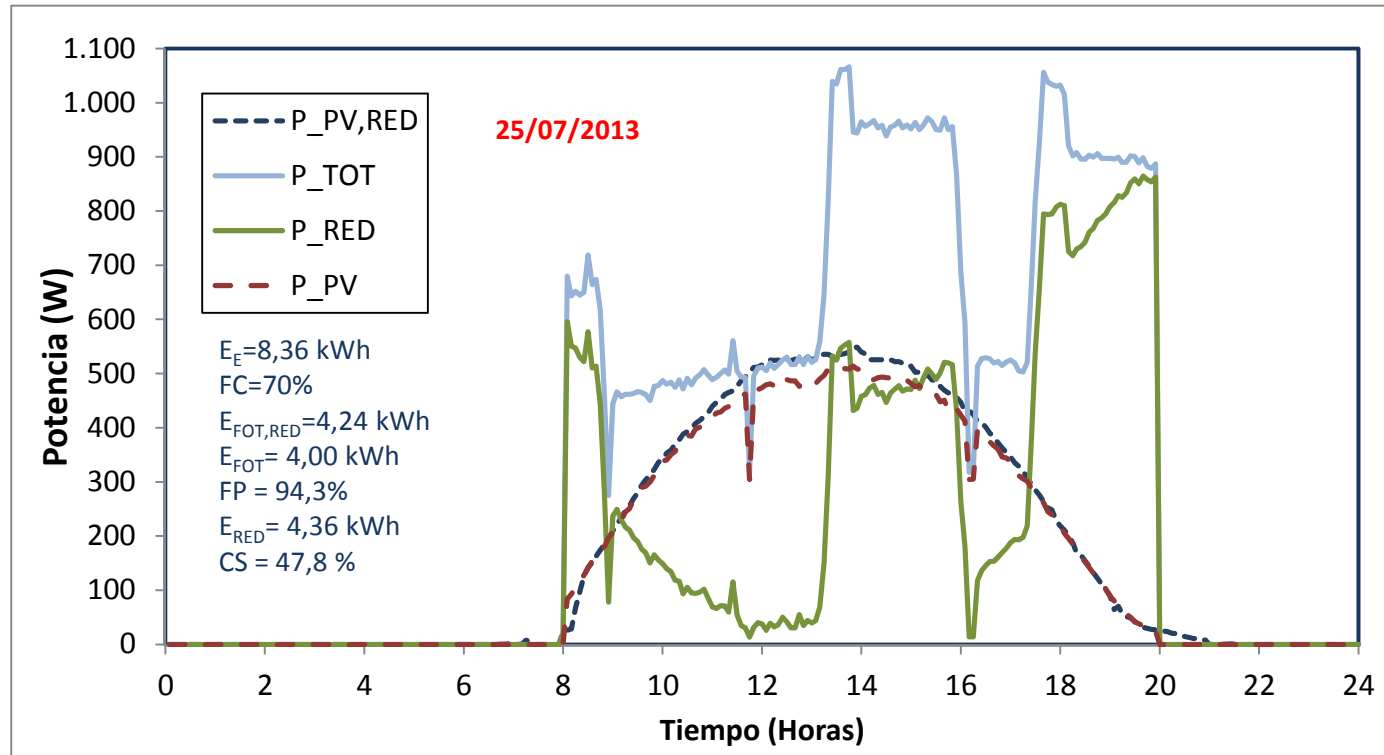

P_{PV} → Electrical power from photovoltaic panels

P_{GRID} → Electrical power from the electrical grid

P_{TOT} → Total Electrical power

$P_{PV,GRID}$ → Electrical power from photovoltaic panels connected to the electrical grid



Horario de 8 a 20 h	E_PV (kWh)	E_RED (kWh)	E_TOT (kWh)	E_PV,RED (kWh)	E_U (kWh)	EER_Maq (-)	EER_Inst (-)	Cont. Sol CS (%)	F. Prod F (%)	T_ext (°C)	T_int (°C)
MAYO	66,0	25,8	91,8	116,8	519,5	6,50	23,12	82,5%	64,9%	24,0	23,3
JUNIO	67,1	18,7	85,7	125,1	514,1	6,00	27,54	78,2%	53,6%	26,8	23,1
JULIO	95,1	75,6	170,7	129,5	720,0	4,22	9,52	55,7%	73,4%	31,1	25,0
AGOSTO	84,8	57,0	141,8	114,7	655,2	4,62	11,49	59,8%	73,9%	30,6	25,0
SEPTIEMBRE	68,2	29,9	98,2	101,0	545,1	5,55	18,21	69,5%	67,5%	27,8	24,3
OCTUBRE	55,4	32,2	87,7	83,6	524,4	5,98	16,26	63,2%	66,3%	26,1	24,1
MODO FRÍO	436,5	239,3	675,8	670,7	3478,4	5,15	14,54	64,6%	65,1%	27,7	24,2

Horario de 8 a 20 h	E_PV (kWh)	E_RED (kWh)	E_TOT (kWh)	E_PV,RED (kWh)	E_U (kWh)	COP_Maq (-)	COP_Inst (-)	Cont. Sol CS (%)	F. Prod F (%)	T_ext (°C)	T_int (°C)
NOVIEMBRE	49,36	65,31	114,64	56,49	465,24	4,06	7,12	43,1%	87,4%	14,9	25,9
DICIEMBRE	51,73	89,47	141,18	56,44	551,67	3,91	6,17	36,6%	91,7%	15,2	24,1
ENERO	61,88	84,97	146,84	70,36	575,30	3,92	6,77	42,1%	87,9%	15,1	25,4
FEBRERO	63,98	83,02	147,00	75,74	532,98	3,63	6,42	43,5%	84,5%	13,6	25,2
MARZO	68,87	72,00	140,87	93,02	531,46	3,77	7,38	48,9%	74,0%	16,8	25,7
ABRIL	58,53	44,79	103,32	101,76	387,67	3,75	8,65	56,6%	57,5%	19,1	24,0
MODO CALOR	354,4	439,6	793,8	453,8	3044,3	3,83	6,93	44,6%	78,1%	15,8	25,0
TOTAL	790,9	678,9	1469,7	1124,5	6522,7	4,44	9,61	53,8%	70,3%	21,7	24,6

CONCLUSIONS

- SOLAR CONTRIBUTION (SC%)
Definition: % of consumed energy which is solar: **54%**
- PRODUCTION FACTOR (PF%)
Definition: % of employed PV energy compared to maximum: **70%**
- EFFICIENCY (SPF)
Definition: Heat + Cool compared to grid electricity: **9,6**

ELECTRICITY EXPORT: NO
BATTERIES: NO
THERMAL STORAGE: NO
COMPRESOR: INVERTER
IMPROVED CONTROL (SOLAR): NO

NUMBER OF PV PANELS: 3
COMPRESOR POWER: 1 kW

DOMESTIC HOT WATER SYSTEMS

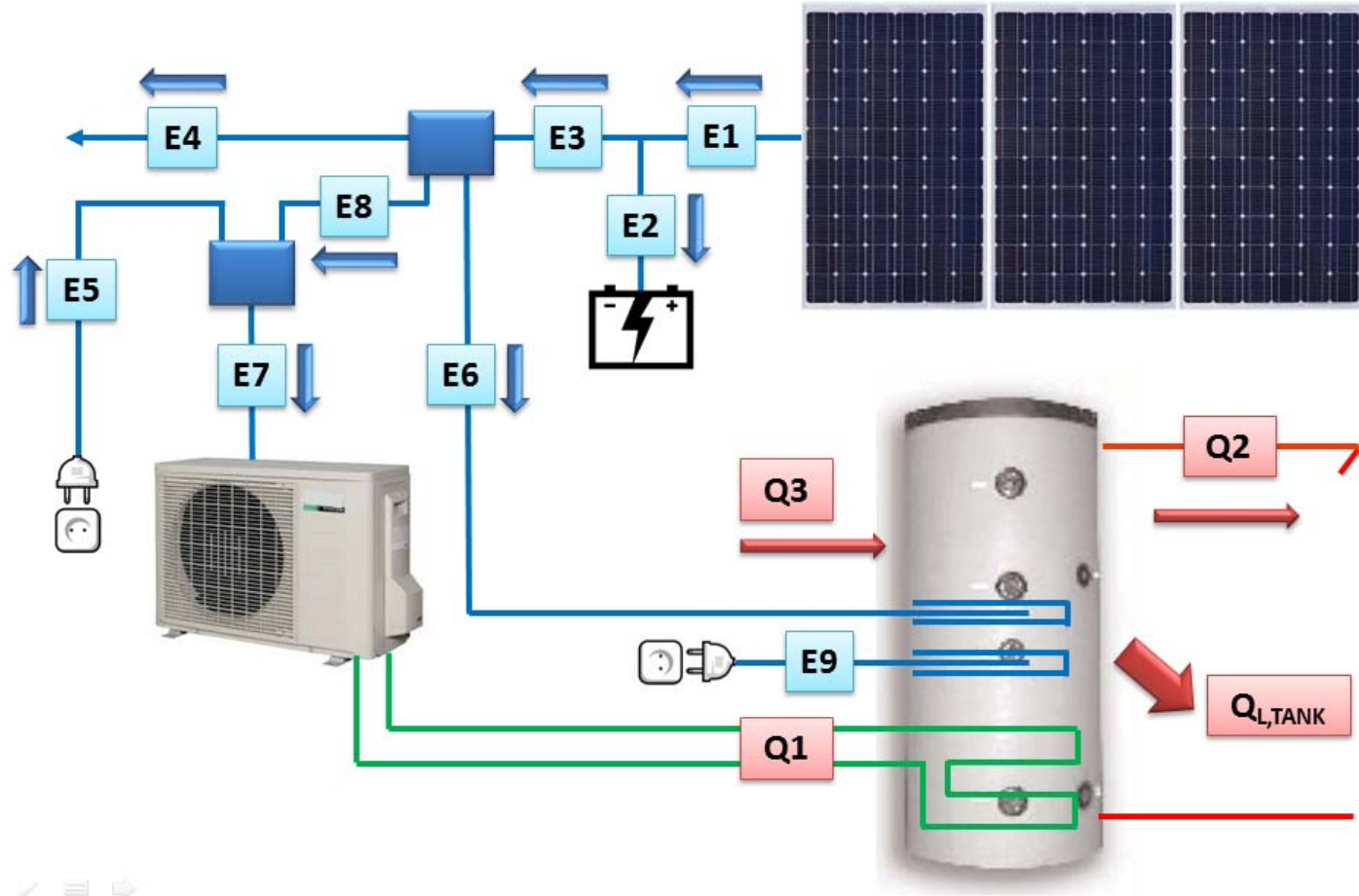

PROTOTYPE UMH-DHW1

DHW consumption of a 4 member family

$P_{PV}=470Wp$

$P_{HP}=1.5kW$



PROTOTYPE UMH-DHW1

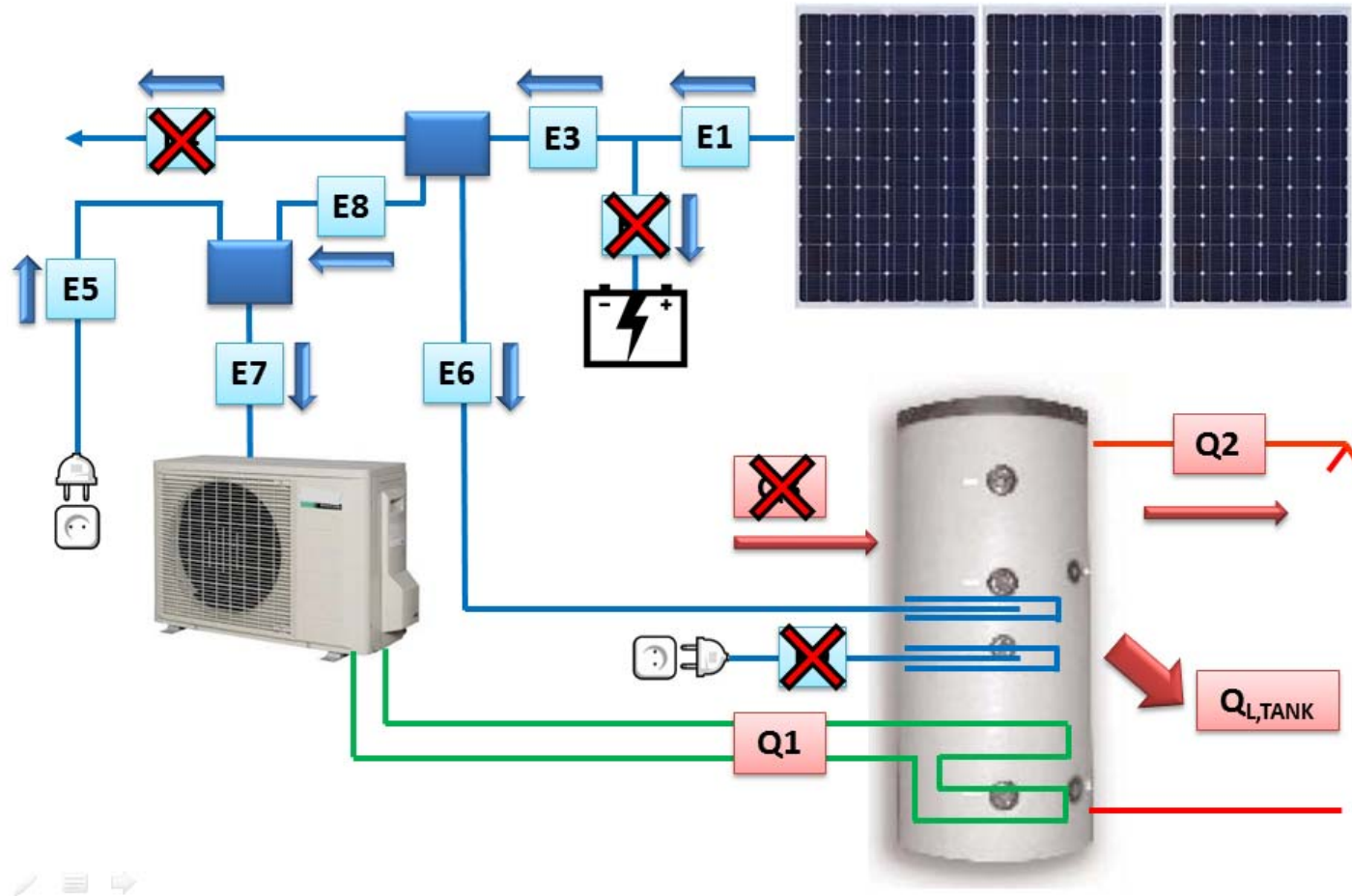

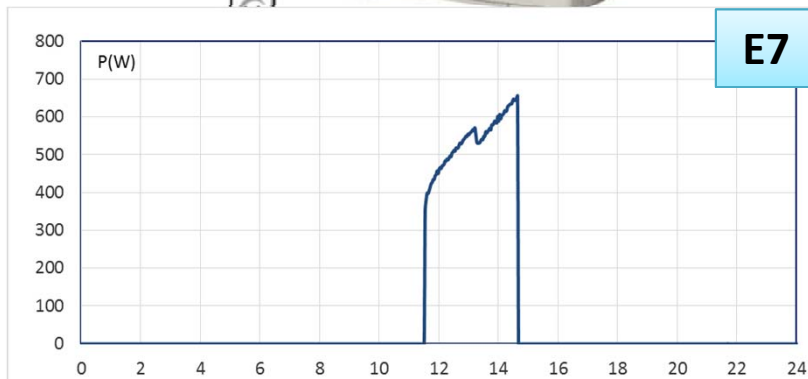
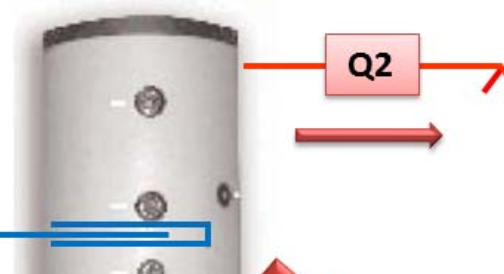
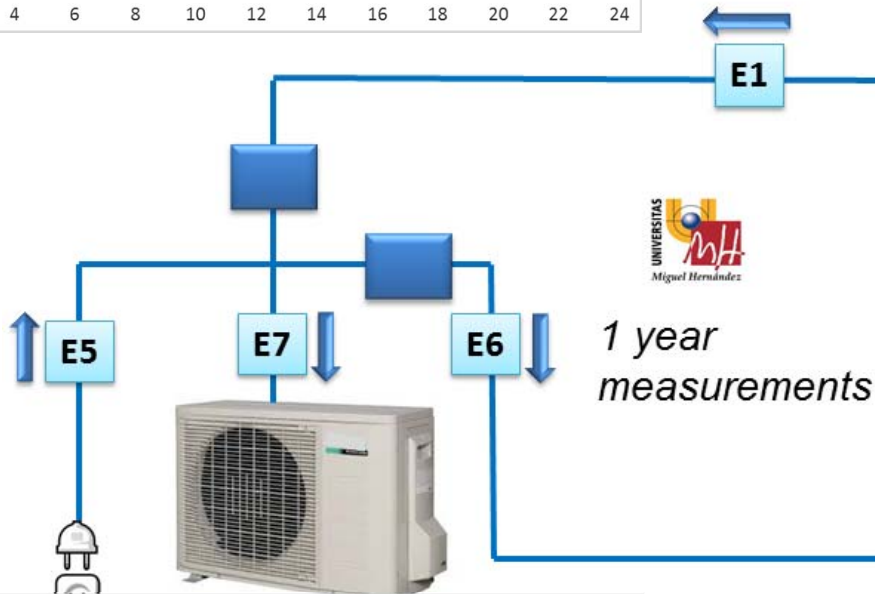
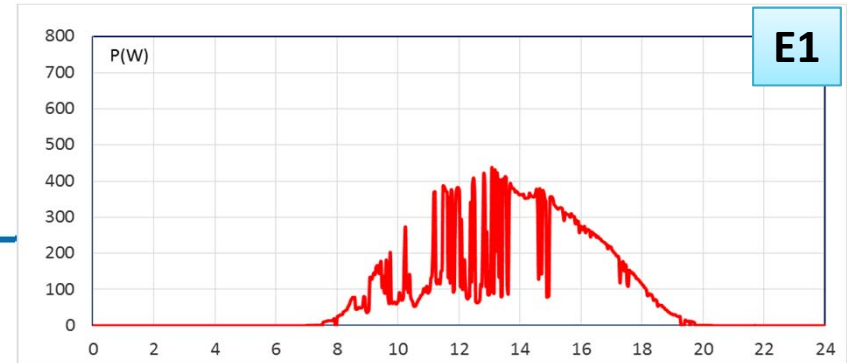
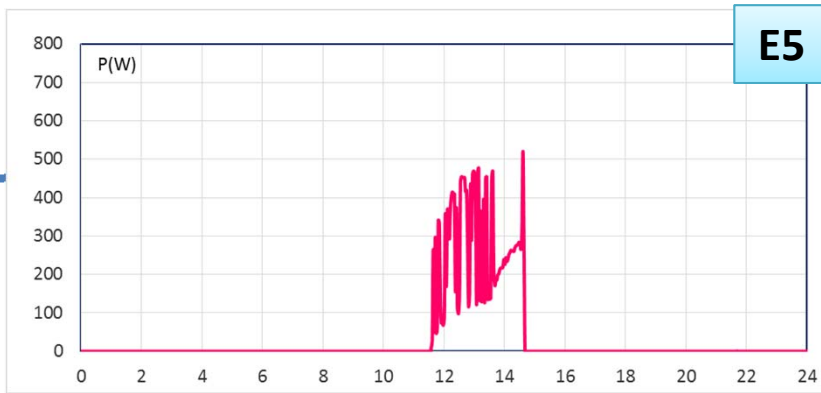

Experimental Results

MONTLY RESULTS

Month	Vol. (L)	Q _s (Kwh)	E _{TANK} (Kwh)	E _w (Kwh)	Q _s (Kwh)	E _T (KWh)	E ₁ (kWh)	E ₂ (kWh)	E ₃ (kWh)	E _{1-E2} (kWh)	Q ₁ (KWh)	Q _{1-Q2} (kWh)	COP _{HP}	COP _{SIST}	T _{M,24h} (°C)	T _{M,HP-ON} (°C)	E _{SOLAR} (kWh/m ²)	SC (%)
January	123,49	5,56	2,15	0,01	7,71	2,30	2,02	0,90	0,61	1,40	6,94	7,55	3,01	8,38	11,40	16,83	5,20	69,11
February	131,67	6,70	2,21	0,42	8,34	2,68	2,08	1,23	0,60	1,44	8,38	8,99	3,30	8,01	13,66	16,28	3,16	62,00
March	133,26	6,92	1,99	0,03	8,93	2,38	2,37	0,88	0,88	1,49	8,54	9,42	3,60	10,68	15,61	19,37	6,17	72,91
April	128,23	6,68	1,74	0,07	8,31	2,03	2,38	0,68	1,22	1,87	7,31	8,74	3,67	12,81	18,73	23,78	6,77	78,16
May	125,73	6,38	1,71	-0,01	8,08	1,96	2,19	0,87	1,10	1,09	7,17	8,27	3,67	9,54	19,53	24,16	5,88	71,61
June	130,83	6,33	1,86	-0,01	7,88	1,77	2,21	0,81	1,24	0,97	6,48	7,72	3,63	8,36	23,78	27,88	3,90	73,21
July	133,61	6,69	1,19	0,01	7,88	1,68	2,39	0,71	1,41	0,98	6,39	7,80	3,80	11,07	26,34	30,32	6,53	77,21
August	133,64	6,66	1,14	0,02	7,82	1,64	2,33	0,76	1,33	0,88	6,48	7,78	3,82	10,24	28,80	30,73	6,23	74,37
September	129,97	6,42	1,20	-0,01	7,62	1,67	2,14	0,80	1,27	0,87	6,34	7,61	3,81	9,56	25,76	29,85	5,86	72,89
October	128,28	6,31	1,44	0,02	7,77	1,80	2,18	0,76	1,13	1,04	6,41	7,36	3,33	8,82	22,12	26,82	3,82	74,20
November	129,06	5,74	1,77	0,02	7,53	2,03	1,62	1,13	0,72	0,89	6,54	7,26	3,23	6,41	16,09	20,29	4,14	58,83
December	123,80	3,67	2,08	0,01	7,70	2,23	1,82	1,04	0,72	1,20	6,78	7,30	3,04	7,23	12,02	16,82	4,88	64,91
TOTAL	47281,70	2318,98	604,95	16,32	2940,25	734,27	787,88	320,73	373,80	414,08	2577,64	2951,44	3,51	9,17	19,41	23,61	2089,71	71,07
AVERAGE	128,86	6,36	1,68	0,04	8,06	2,01	2,16	0,88	1,02	1,13	7,06	8,08	3,61	8,17	18,41	23,61	6,73	71,07

CONCLUSIONS

- SOLAR CONTRIBUTION (SC%)
Definition: % of consumed energy which is solar: **71%**
- PRODUCTION FACTOR (PF%)
Definition: % of employed PV energy compared to maximum: **100%**
- EFFICIENCY (SPF)
Definition: Heat + Cool compared to grid electricity: **9,1**

ELECTRICITY EXPORT: NO
BATTERIES: NO
THERMAL STORAGE: YES
COMPRESOR: W=CONSTANT
IMPROVED CONTROL (SOLAR): YES

NUMBER OF PV PANELS; 2
COMPRESOR POWER: 500 W
STORAGE CAPACITY: 200 LITERS

PROTOTYPE UMH-DHW2

DHW consumption of a 4 member family



GENERAL APPROACH

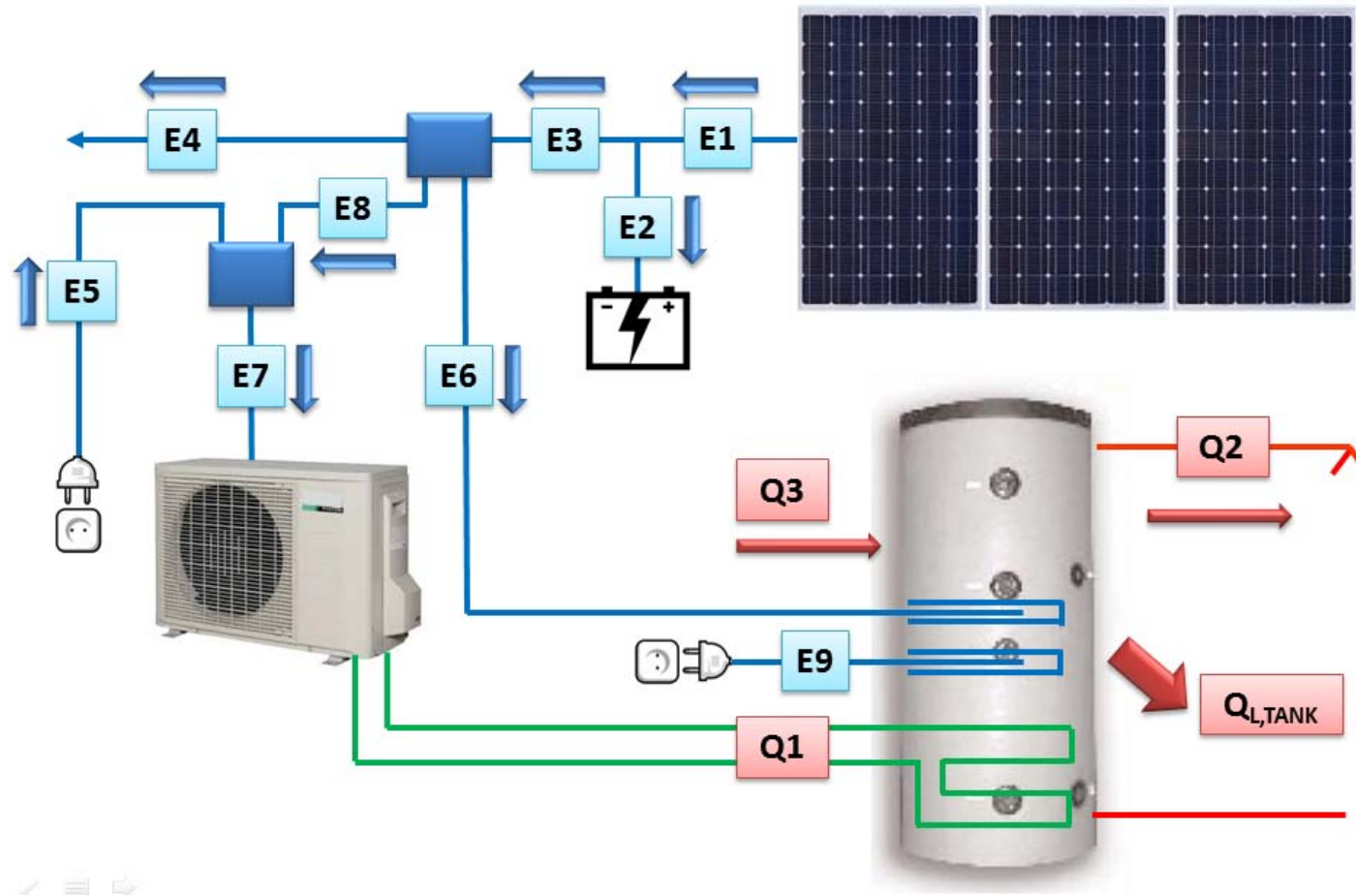

PROTOTYPE UMH-DHW2

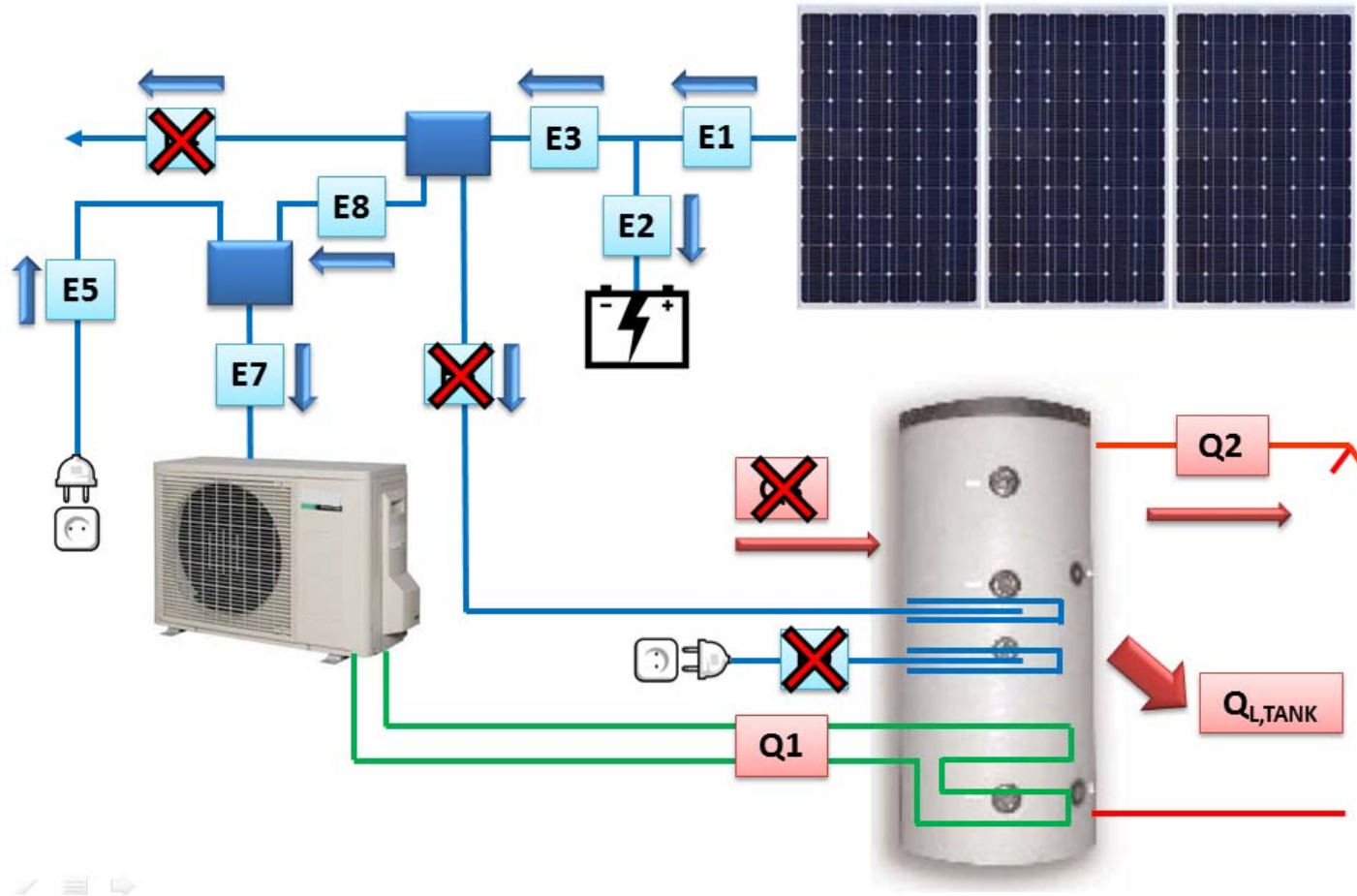

PROTOTYPE UMH-DHW2

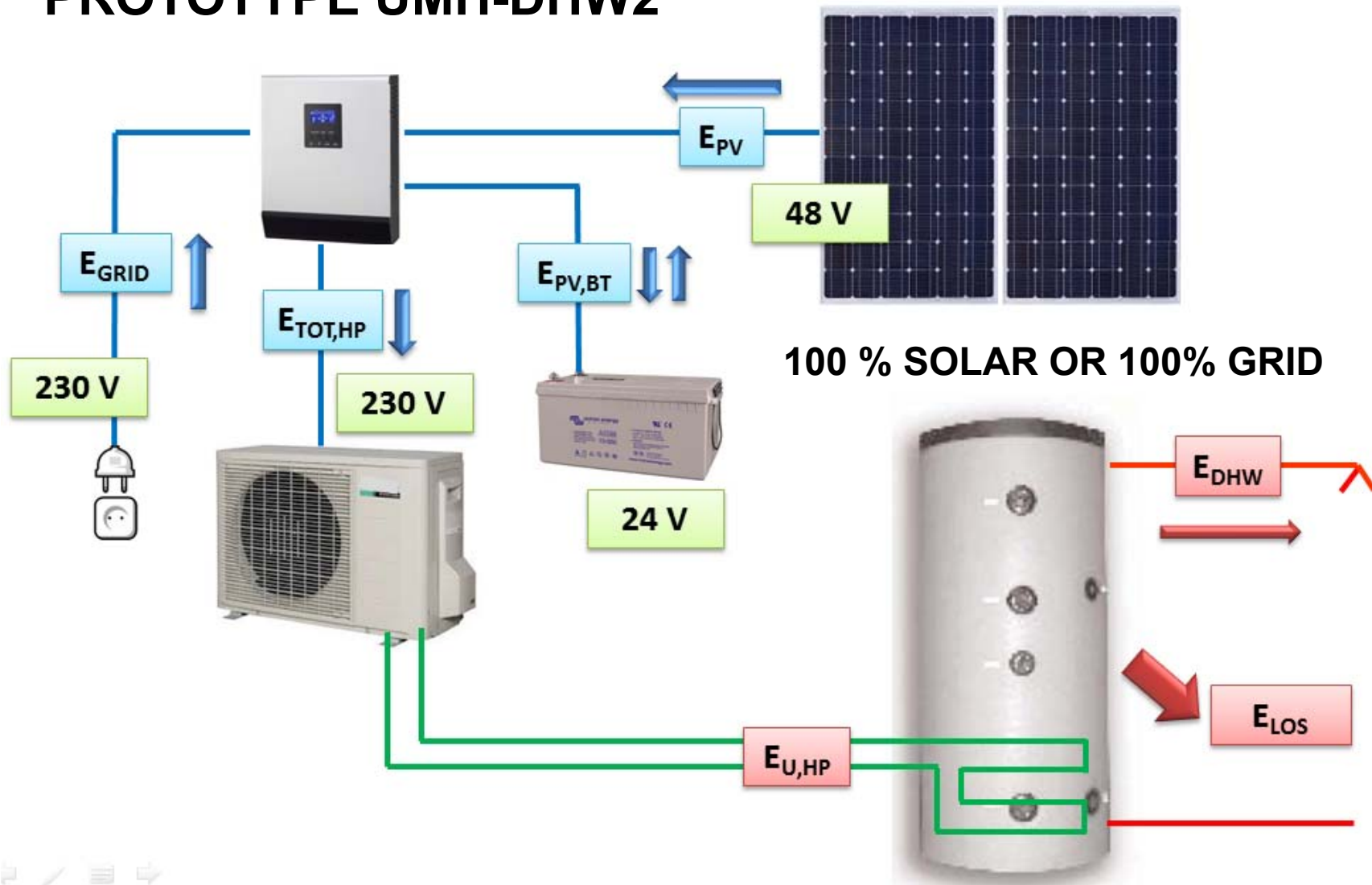

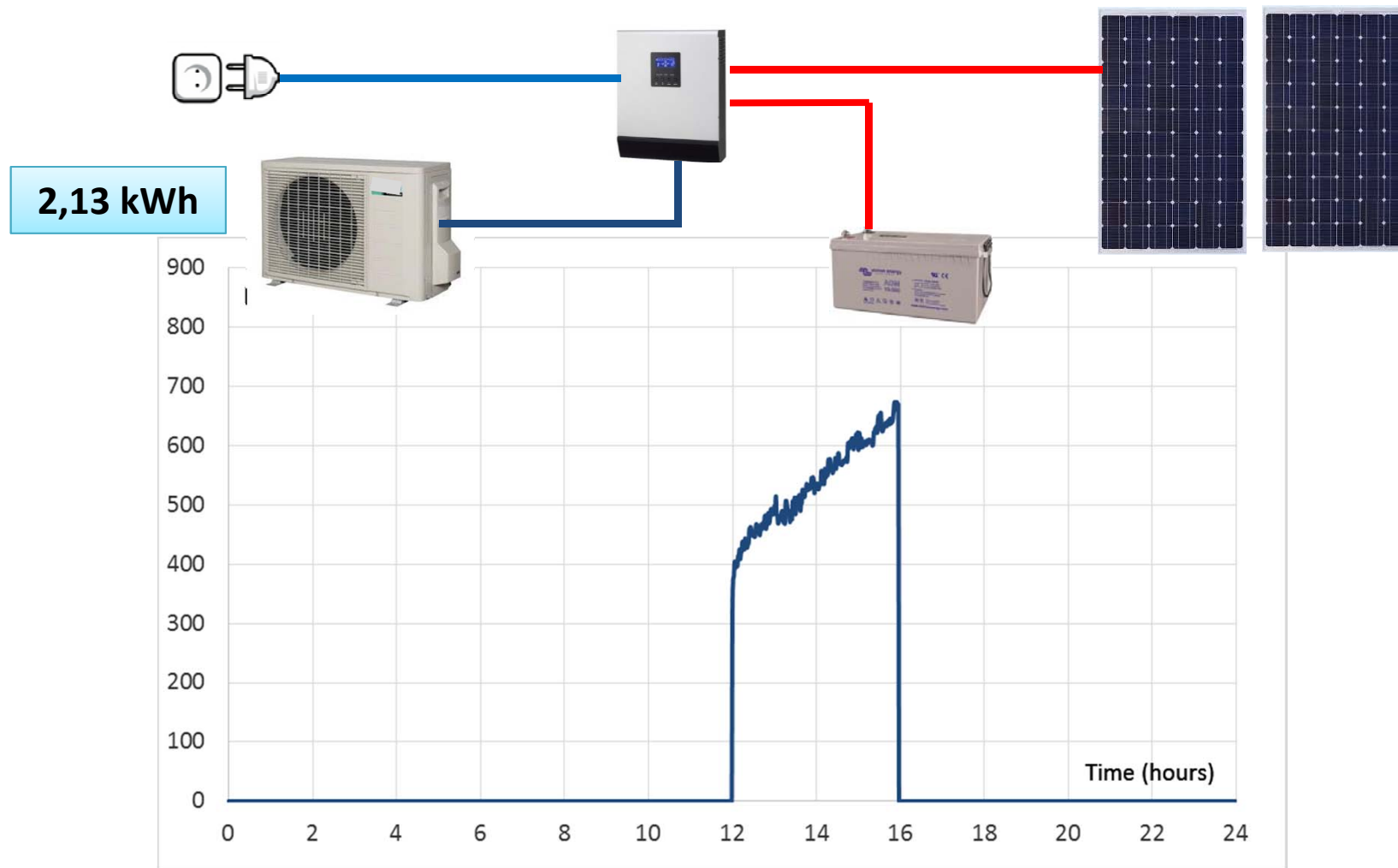

16/SEP/2015

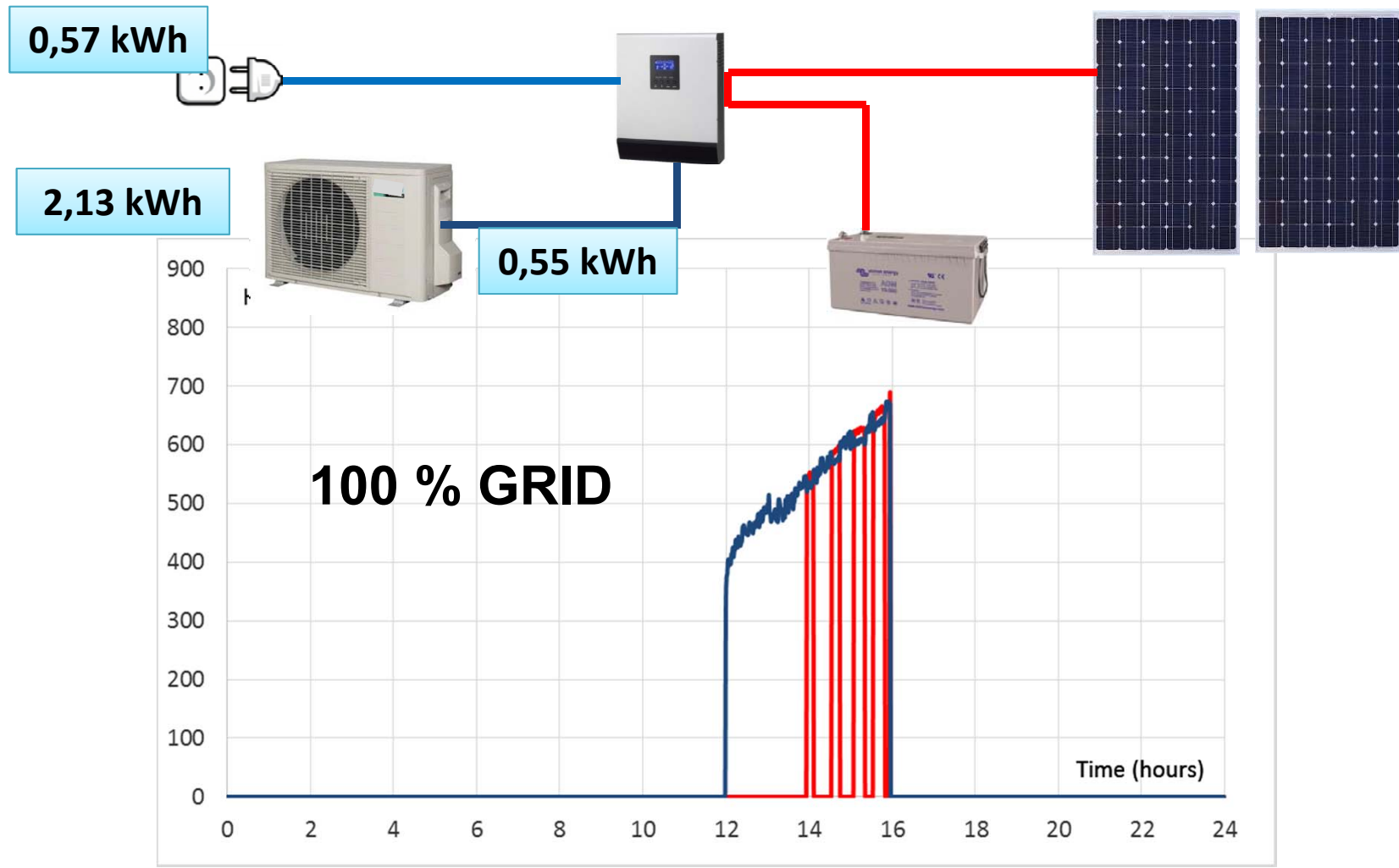

16/SEP/2015

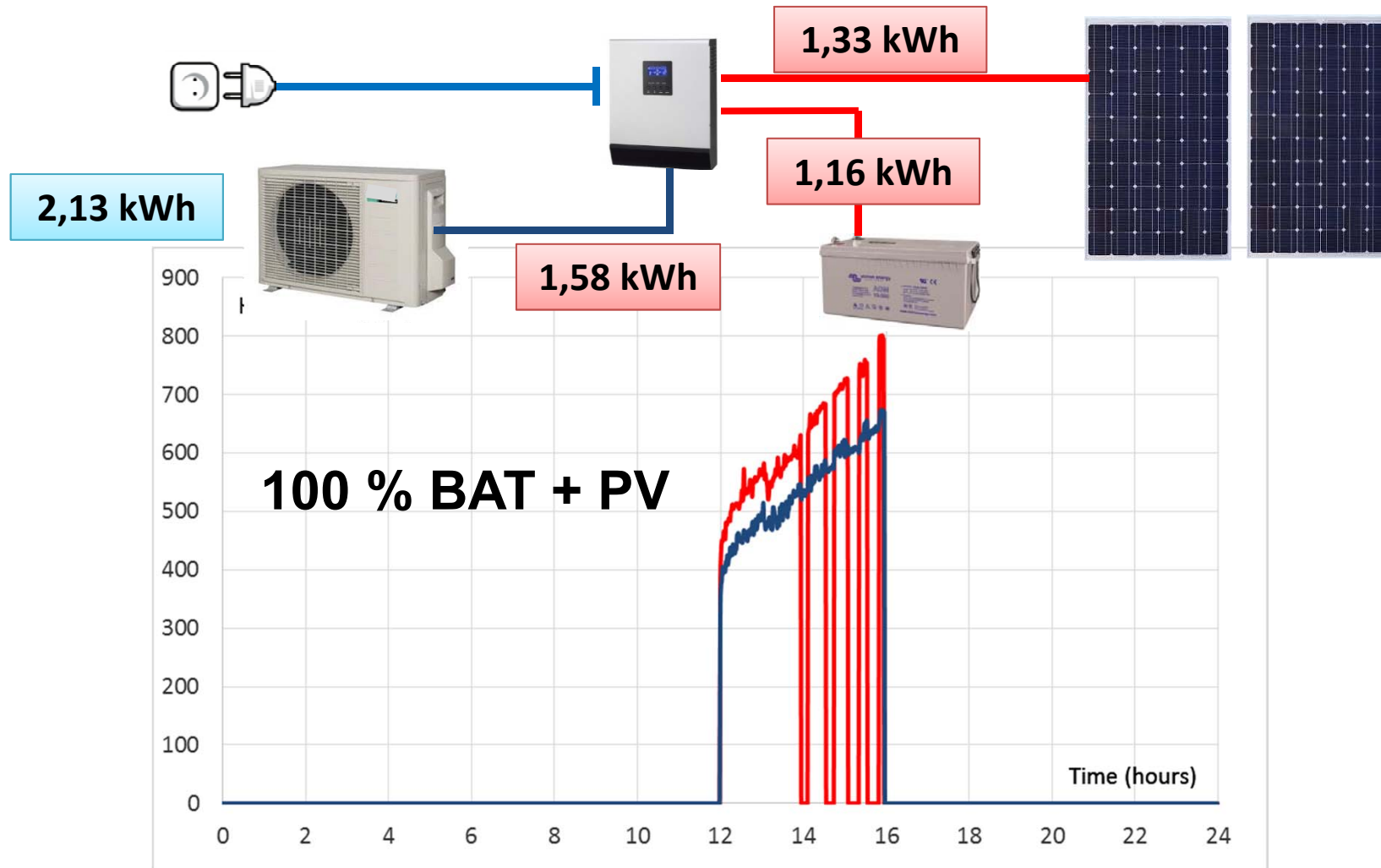

16/SEP/2015

CONCLUSIONS 1 DAY 16/SEP/2015!!!!!!

- SOLAR CONTRIBUTION (SC%)
Definition: % of consumed energy which is solar: **74%**
- PRODUCTION FACTOR (PF%)
Definition: % of employed PV energy compared to maximum: **100%**
- EFFICIENCY (SFP)
Definition: Heat + Cool compared to grid electricity: **10,8**

ELECTRICITY EXPORT: NO
BATTERIES: YES
THERMAL STORAGE: YES
COMPRESOR: W=CONSTANT
IMPROVED CONTROL (SOLAR): YES

NUMBER OF PV PANELS: 2
COMPRESOR POWER: 500 W
BATTERIES CAPACITY: 150 Ah
STORAGE CAPACITY: 200 LITERS

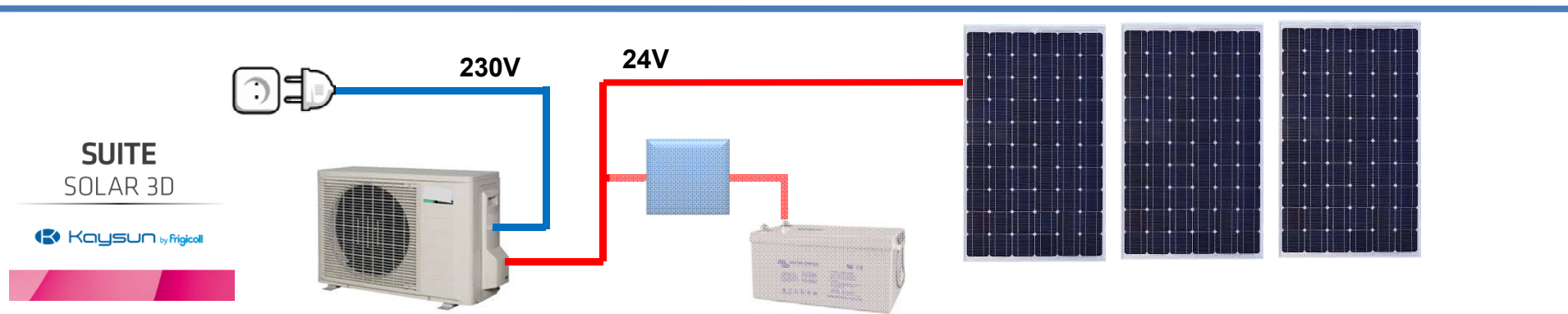

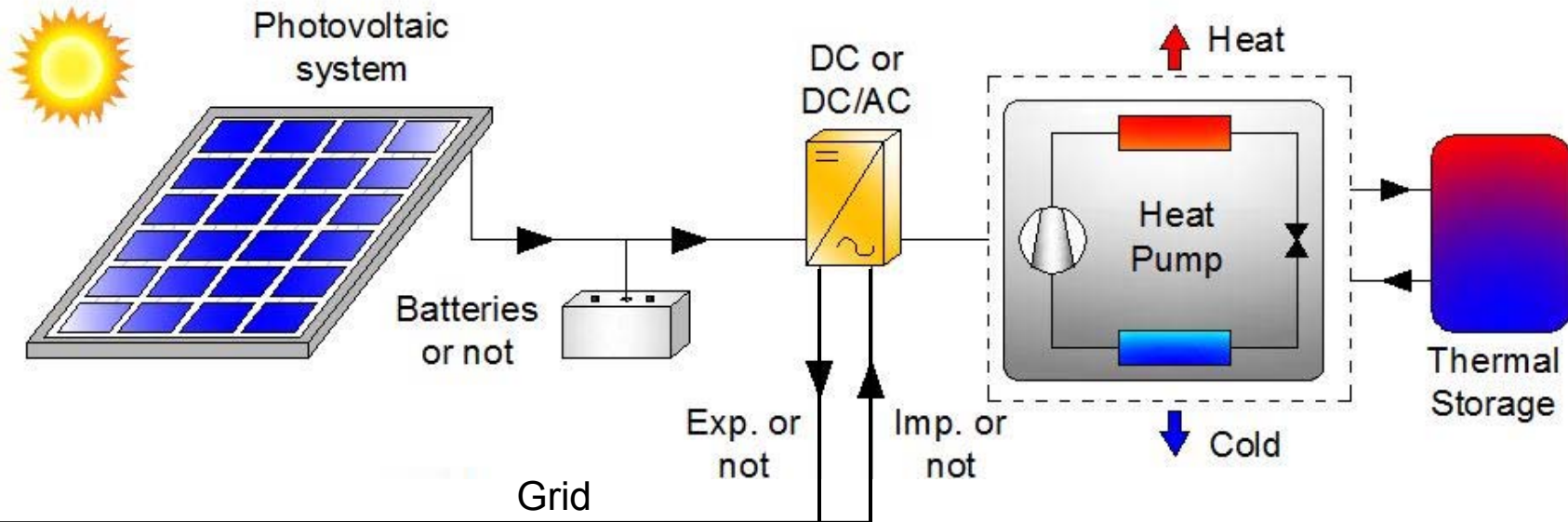

DESING CHARACTERISTICS

- ELECTRICITY EXPORT: YES/NO
- BATTERIES: YES/NO
- THERMAL STORAGE: YES/NO
- COMPRESOR: INVERTER, W=CONSTANT
- IMPROVED CONTROL (SOLAR)

DIMENSIONS:

- NUMBER OF PV PANELS
- COMPRESOR POWER
- BATTERIES: Ah
- STORAGE CAPACITY

Examples of solar cooling innovations in SHC Task 53

Pedro V. Quiles

Universidad Miguel Hernández de Elche

pedro.vicente@umh.es

<http://dime.umh.e>

Francisco J. Aguilar Valero

Universidad Miguel Hernández de Elche

Simón Aledo Vives

simon@prointer.es

Prointer, S.L.

